



# Fasteners engineered with engineers in mind.

Our No-Equal<sup>®</sup> fasteners make engineers' jobs easier. Their high-performance design increases your allowable loads while speeding installation — lowering labor and materials costs. You can specify screws and nails easily through our Solid Wood web app, and quickly get the products you need from our European-wide network of warehouses.

Quality. Speed. Strength. Availability. Work smarter with Simpson Strong-Tie<sup>®</sup> fasteners.



$$F_{es}$$

$$\frac{F_{em}}{R_e} R_d$$

$$\frac{F_{em}}{R_e} R_d$$

$$\frac{2F_{em} F_{yb}}{3(1+R_e)}$$

$$R_e^2 + R_e^3 - R_e$$

$$(1+2R_e)D^2$$

$$3F_{em} l_m^2$$

$$(2+R_e)D^2$$

$$F_{em} l_s^2$$

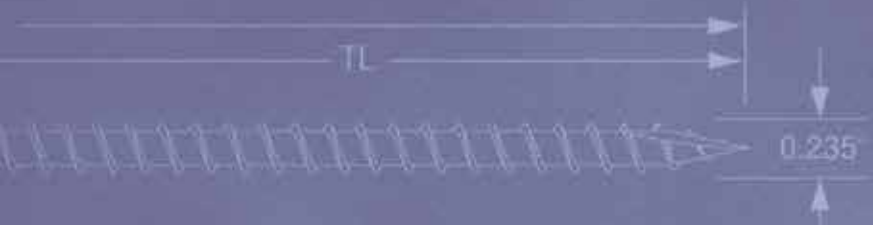
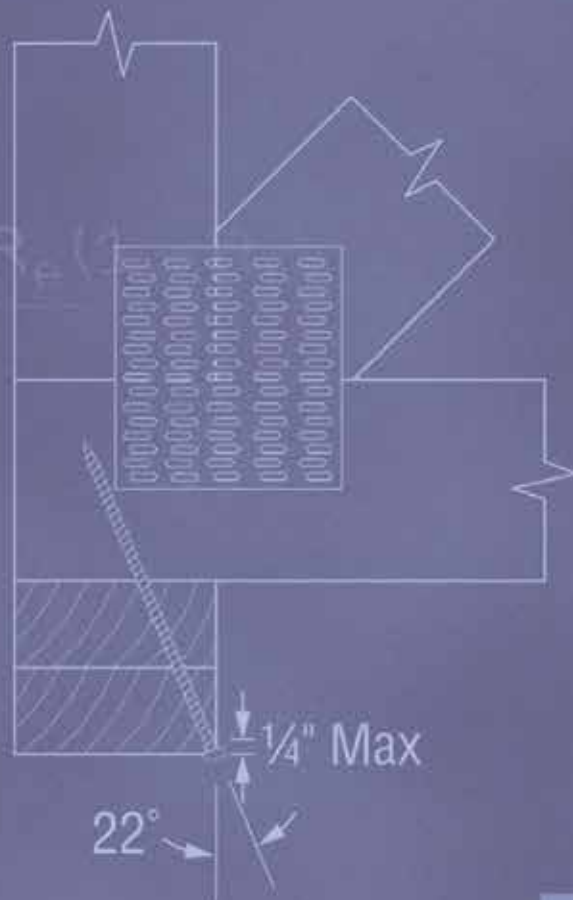
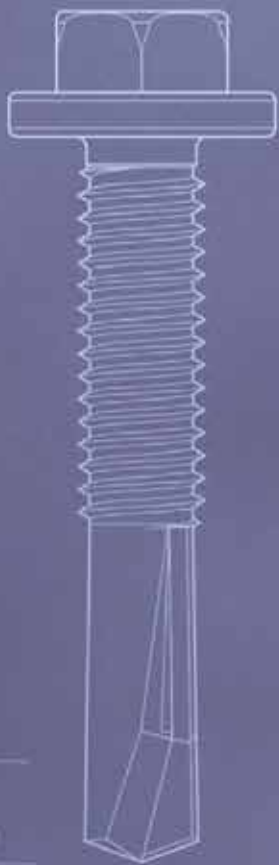

**SIMPSON**

**Strong-Tie**

# Table of Contents

## 1. General Information

Company Information	10
Online Tools & Support for Engineers	12
Fastener Features	13
Fastener Types and Sizes	14
Application Matrix	15
ETA-approval	16
Calculation and Design of Screw Connections	19
Timber Grades	20
Correction Factors	21
Pre-Drilling	21
Space and Edge Distance	22
Hole Diameter Steel	29
Space and Edge Distance Steel	29
Screw Resistance	30
Combined Oblique Stresses	31
Fire Calculation for Screws	32
Corrosion	35
Solid Wood Software	37

## 2. Fastener Range with Characteristic Parameters

TTUFS/TTZNFS/TTSFS Countersunk WOOD Screw	40
SWW/SWWZ Washer-Head WOOD Screw	44
SWC Countersunk WOOD Screw	48
SWD Double-Threaded WOOD Screw	50
SSH Hex-Head CONNECTOR Screw	52
SSF Flat Round-Head CONNECTOR Screw	54
ESCRFTC Full-Threaded Countersunk WOOD Screw	56
ESCRFTZ Full-Threaded Cylinder-Head WOOD Screw	58
ESCRFT Full-Threaded Cylinder-Head WOOD Screw	60
ESCR2R Double-Threaded Cylinder Head WOOD Screw	62
CSA/CSA-Z/CSA-S CONNECTOR Screw	64
CNA/CNA-G/CNA-S CONNECTOR Nail	66
WSV Quik Drive® Collated WOOD Screw	68
SDW/SDWS Structural WOOD Screw	70

## 3. Timber to Timber

### 3.1 Solid Timber Fastening

TTUFS, TTZNFS, TTSFS	74
SWW, SWWZ	81
SWC	89
SWD	94
SSH	97
ESCRFTC, ESCRFTZ	102
ESCRFT	109
SDW, SDWS	112

### 3.2 Glulam

#### 3.2 Glulam Fastening

TTUFS, TTZNFS, TTSFS	119
SWW, SWWZ	126
SWC	134
SWD	139
SSH	142
ESCRFT	145
ESCRFTC, ESCRFTZ	150
SDW, SDWS	155

#### 3.2.1 Glulam Inclined Installations

SWD	160
ESCRFTZ	161
ESCRFT	162

#### 3.2.2 Glulam Cross Pairs

SWD	165
ESCRFTZ	166
ESCRFT	167

#### 3.2.3 Glulam Reinforcement

ESCRFTC	171
---------	-----

## 3.3 CLT

### 3.3.1 90° T-Connections between CLT Panels

TTUFS	183
SWW, SWWZ	184
SWC	187
SWD	191
ESCRFTZ, ESCRFTC	192

### 3.3.2 Solid-Timber Wall-Plate to CLT Panel Connections

TTUFS	195
SWW, SWWZ	196
SWC	198
SWD	201
ESCRFTZ, ESCRFTC	202
ESCRFT	204

### 3.3.3 CLT Half-Lap Connections

TTUFS	206
SWW, SWWZ	208
SWC	210
SWD	213
ESCRFTZ	214
ESCRFT	215

### 3.3.4 CLT Butt-Joint Connections

SWD	217, 220
ESCRFTZ	218, 221
ESCRFT	219, 222

### 3.3.5 CLT Spline Connections

TTUFS	223
WSV	225

## 4. Steel to Timber

SSH	230
SSF	234
CSA	236
CSA-Z	237
CSA-S	237
CNA	239
CNA-G	240
CNA-S	240
TTUFS	242
TTZNFS	244
TTSFS	246
SWC	248
ESCRFTC	251

## 5. Boards to Timber

WSV	256
TTUFS	258
TTZNFS	260
TTSFS	262

# Alphabetical Index

## CNA/CNA-G/CNA-S

Structural Connector Nail for Steel to Timber . . . 239

## CSA/CSA-Z/CSA-S

Structural Connector Screw for Steel to Timber 236

## ESCRFT

Full Threaded WOOD Screw for

Butt-Joint CLT Connection . . . . . 219, 222  
 Cross Pairs . . . . . 167  
 Glulam . . . . . 152  
 Half-Lap CLT Connection . . . . . 215  
 Inclined Installations . . . . . 162  
 Solid-Timber Wall-Plate to CLT Panel . . . . . 204  
 T-Connections Between CLT Panels . . . . . 193  
 Timber to Timber . . . . . 109

## ESCRFTC

Full Threaded WOOD Screw for

Glulam . . . . . 145  
 Seat Reinforcement . . . . . 171  
 Solid-Timber Wall-Plate to CLT Panel . . . . . 203  
 Steel to Timber . . . . . 251  
 Timber to Timber . . . . . 102

## ESCRFTZ

Full Threaded WOOD Screw for

Butt-Joint CLT Connection . . . . . 218, 221  
 Cross Pairs . . . . . 166  
 Glulam . . . . . 150  
 Half-Lap CLT Connection . . . . . 214  
 Inclined Installations . . . . . 161  
 Solid-Timber Wall-Plate to CLT Panel . . . . . 202  
 T-Connections Between CLT Panels . . . . . 192  
 Timber to Timber . . . . . 107

## SDW

Structural WOOD Screw for

Glulam . . . . . 112  
 Timber to Timber . . . . . 112  
 Glulam . . . . . 157

## SDWS

Structural WOOD Screw for Timber to Timber . . 114

## SSF

Structural Flat Round Head Connector Screw for

Steel to Timber . . . . . 234

## SSH

Structural Hex-Head Connector Screw for

Steel to Timber . . . . . 230  
 Glulam . . . . . 142  
 Timber to Timber . . . . . 97

## SWC

Structural Countersunk WOOD Screw for

Glulam . . . . . 134  
 Half-Lap CLT Connection . . . . . 210  
 Solid-Timber Wall-Plate to CLT Panel . . . . . 198  
 Steel to Timber . . . . . 248  
 T-Connections Between CLT Panels . . . . . 187  
 Timber to Timber . . . . . 89

## SWD

Double Threaded WOOD Screw for

Butt-Joint CLT Connection . . . . . 217, 220  
 Cross Pairs . . . . . 165  
 Glulam . . . . . 139  
 Half-Lap CLT Connection . . . . . 213  
 Inclined Installations . . . . . 160  
 Solid-Timber Wall-Plate to CLT Panel . . . . . 201  
 T-Connections Between CLT Panels . . . . . 191  
 Timber to Timber . . . . . 94

## SWW

Structural Washer-Head WOOD Screw for

Glulam . . . . . 126  
 Half-Lap CLT Connection . . . . . 206  
 Solid-Timber Wall-Plate to CLT Panel . . . . . 196  
 T-Connections Between CLT Panels . . . . . 184  
 Timber to Timber . . . . . 81

## SWWZ

Structural Washer-Head WOOD Screw for

Glulam . . . . . 131  
 Timber to Timber . . . . . 86

## TTSFS

Structural Countersunk WOOD Screw for

Boards to Timber . . . . . 262  
 Glulam . . . . . 123  
 Timber to Timber . . . . . 78  
 Steel to Timber . . . . . 246

## TTUFS

Structural Countersunk WOOD Screw for

Boards to Timber . . . . . 258  
 Glulam . . . . . 119  
 Half-Lap CLT Connection . . . . . 206  
 Solid-Timber Wall-Plate to CLT Panel . . . . . 195  
 CLT Spline Connection . . . . . 223  
 Steel to Timber . . . . . 242  
 T-Connections Between CLT Panels . . . . . 183  
 Timber to Timber . . . . . 74

## TTZNFS

Structural Countersunk WOOD Screw for

Boards to Timber . . . . . 260  
 Glulam . . . . . 121  
 Steel to Timber . . . . . 244  
 Timber to Timber . . . . . 76

## WSV

Countersunk WOOD Screw for

Boards to Timber . . . . . 256  
 CLT Spline Connection . . . . . 225



# Solid Wood

## Fastener Dimensioning Software

In just four simple steps, Solid Wood helps you calculate and select fastening solutions suitable for the specific wood structure at hand, according to Eurocode 5 and our ETA.

- **Time saving** - Quicker and easier than manual calculations
- **Safety** - Removes any doubt in the precision of your manual calculations
- **Product guide** - Helps you find the correct product for your application

The software generates a PDF-report that can be used as documentation for the project.



### Calculation in four simple steps.

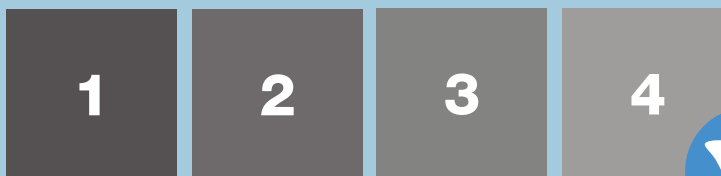

# Calculating fasteners for wood has never been easier.

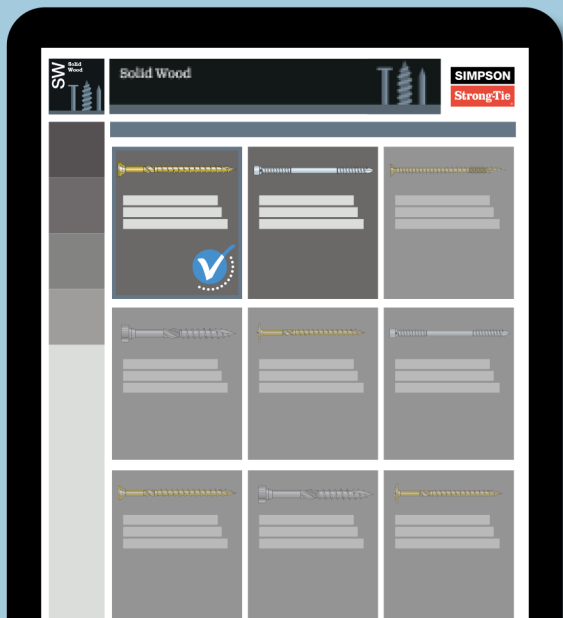

[solidwood.strongtie.eu](https://solidwood.strongtie.eu)





# Exceptional strength.

ESCRFTZ Structural Full-Threaded WOOD Screw



# General Information

- Company Information .....10
- Online Tools & Support for Engineers .....12
- Fastener Features .....13
- Fastener Types and Sizes .....14
- Application Matrix .....15
- ETA-approval .....16
- Calculation and Design of Screw Connections.....19
- Timber Grades .....20
- Correction Factors .....21
- Pre-Drilling .....21
- Space and Edge Distance .....22
- Hole Diameter Steel .....29
- Space and Edge Distance Steel .....29
- Screw Resistance .....30
- Combined Oblique Stresses .....31
- Fire Calculation for Screws .....32
- Corrosion .....35
- Solid Wood Software .....37

## Company Information

For more than 60 years, Simpson Strong-Tie® has focused on creating structural products that help people build safer and stronger homes and buildings. A leader in structural systems research and technology, Simpson Strong-Tie® is one of the largest suppliers of structural building products in the world. Our commitment to product development, engineering, testing and training is evident in the consistent quality and delivery of our products and services.

For more information, visit the company's website at [strongtie.eu](http://strongtie.eu)

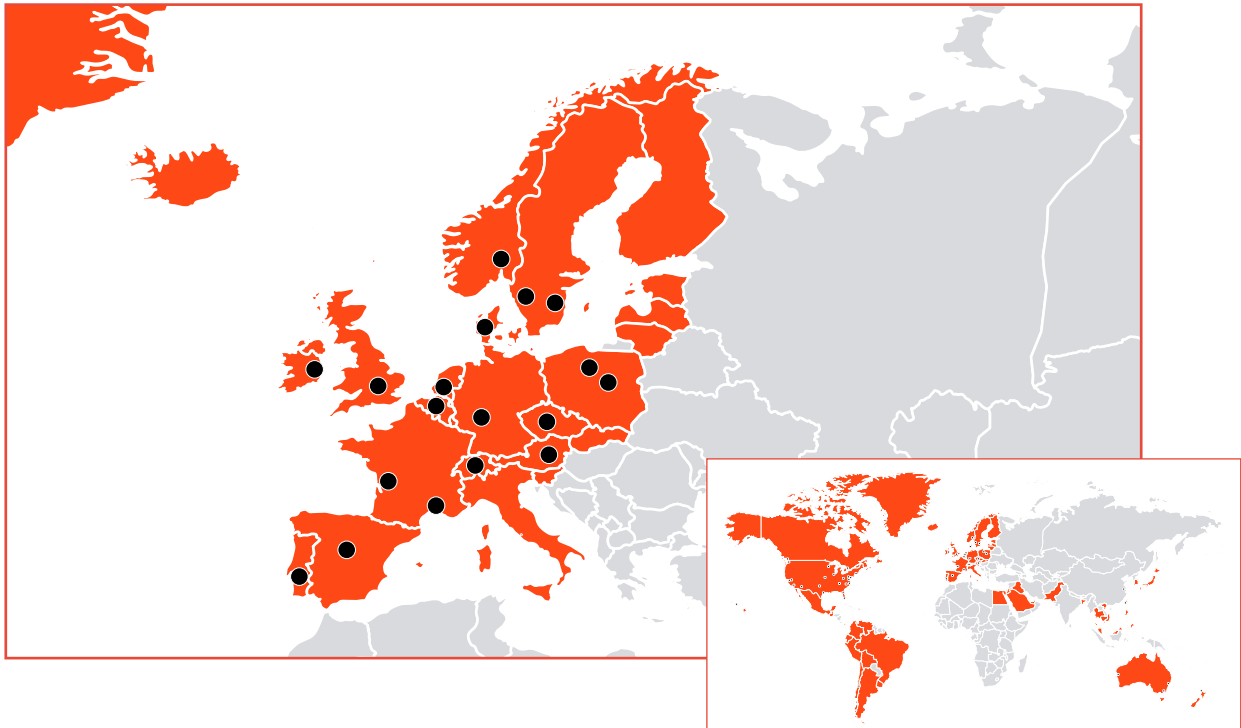

● Factories, offices, or warehouses in Australia, Austria, Belgium, Canada, Chile, China, Czech Republic, Denmark, France, Germany, Ireland, Italy, Netherlands, New Zealand, Norway, Poland, Portugal, Spain, Sweden, Switzerland, Taiwan, UK and USA

■ Distribution in Australia, Canada, Chile, Western Europe, part of Eastern Europe, Middle East, Egypt, Japan, Korea and other Asian countries, Mexico, New Zealand, UK, part of South America and USA

## European Fastener Manufacturing

Simpson Strong-Tie® has several manufacturing facilities placed strategically across the European continent, to ensure a high degree of product availability and a strong understanding of the local markets. We have fastener manufacturing in various locations across Europe and our close-knit logistical network ensures that there is always a Simpson Strong-Tie warehouse or distributor near you.

© Simpson Strong-Tie - [strongtie.eu](http://strongtie.eu)

All rights reserved. This catalogue may not be reproduced in whole or in part without the prior written approval of Simpson Strong-Tie Company Inc.

## Company Information

# The Simpson Strong-Tie® Company Inc. “No Equal” Pledge Includes:

- Quality products value-engineered for the lowest installed cost at the highest-rated performance levels
- Most thoroughly tested and evaluated products in the industry
- Strategically located manufacturing and warehouse facilities
- National code agency listings
- Largest number of patented connectors in the industry
- European locations with an international sales team
- In-house R&D and tool and die professionals
- In-house product testing and quality control engineers

## Quality Policy

We help people build safer structures economically. We do this by designing, engineering and manufacturing “No Equal” structural connectors and other related products that meet or exceed our customers’ needs and expectations.

Everyone is responsible for product quality and is committed to ensuring the effectiveness of the Quality Management System. Simpson Strong-Tie® is an ISO 9001 registered company. ISO 9001 is an internationally recognised quality management system standard, which lets our customers know that they can count on the consistent quality of Simpson Strong-Tie’s products and services.

**Mike Olosky**  
Chief Executive Officer

## Testing Laboratory Accreditation



The Andris Peterson European Test Laboratory, located in the UK in Tamworth, Staffordshire, is the first manufacturer’s facility to achieve third party accreditation to the international standard BS EN ISO/IEC 17025.

The world-class facility now conducts around 10,000 product tests annually and has recently benefited from a significant investment, which will enable double productivity. The fact that we extensively test our products give you the reassurance that they will perform in the toughest conditions. We strive to ensure that our products are compliant with the latest European requirements for construction products.



### We Are ISO 9001-2015 Registered

Simpson Strong-Tie is an ISO 9001-2015 registered company. ISO 9001-2015 is an internationally-recognized quality assurance system which lets our domestic and international customers know that they can count on the consistent quality of Simpson Strong-Tie® products and services.



### ISO 14001

Our Swedish, French (St. Gemme la Pleine) and UK facilities are ISO 14001 certified. This standard states the requirements for an environmental management system, and applies to the environmental aspects over which our company has control and can be expected to have an influence.



### OHSAS 18001

Our Tamworth, UK facility is OHSAS 18001 certified. This certification reflects an internationally applied British Standard for occupational health and safety management systems.

To learn more about these certifications and organizations, please visit [ISO.org](http://ISO.org), [ICCSafe.org](http://ICCSafe.org) and [bsigroup.com](http://bsigroup.com).

### 1. General Information

8 - 37

### 2. Fastener Range with Characteristic Parameters

38 - 71

### 3.1 Solid Timber

72 - 117

3. Timber to Timber

### 3.2 Glulam

118 - 179

### 3.3 CLT

180 - 227

### 4. Steel to Timber

228 - 253

### 5. Boards to Timber

254 - 263

General Information



## Online Tools & Support for Engineers



### Technical Support

Experts in structural wood engineering, Simpson Strong-Tie is always at your side, making life easier with complete solutions, effective support, tools and advice.

With our proven track-record for service and support, peace of mind comes built-in. It's part of an engineer's DNA to plan for the unexpected. We've already spent over six decades doing just that.

We are with you every step of the way; from planning and tendering to site-build, we have people on the ground to support the process and to give further guidance. Our Technical Support team is on hand to answer your questions and provide some sound installation advice, from making sure you have the most suitable product, to the best ways to go about installing them.



### CAD/BIM Library

Any 2D and 3D model of our Solid-Drive fasteners can be immediately integrated into building designs and design software.

We know how useful the drawings of our fasteners can be for you. That is why we offer our drawings in the following formats for free download:

- 2D / 3D DWG
- SAT
- 2D / 3D Revit
- XML
- BIM

Please note that you will need at least CAD software to open some of the files. You can get a free file reader at: Autodesk Review.



### DoP/ETA Library

Our entire library of DoP (Declaration of Performance) and ETA documentation is available online. Here we provide DoP's in all main European languages.

If you know the name of the product family, you can search on each of our websites, or —alternatively— browse the products section as the relevant DoP and ETA file can also be found on each individual product's detail page.

Go to [strongtie.eu](http://strongtie.eu) to find more.

## Solid Wood Fastener Dimensioning Software



In just four simple steps, Solid Wood guides you through the calculation and selection of fastening solutions suitable for the specific wood structure at hand, all according to Eurocode 5 and our ETA.

Try Solid Wood today.

Go to [solidwood.strongtie.eu](http://solidwood.strongtie.eu)

# Fastener Features

- Head styles
- Shank styles
- Point styles

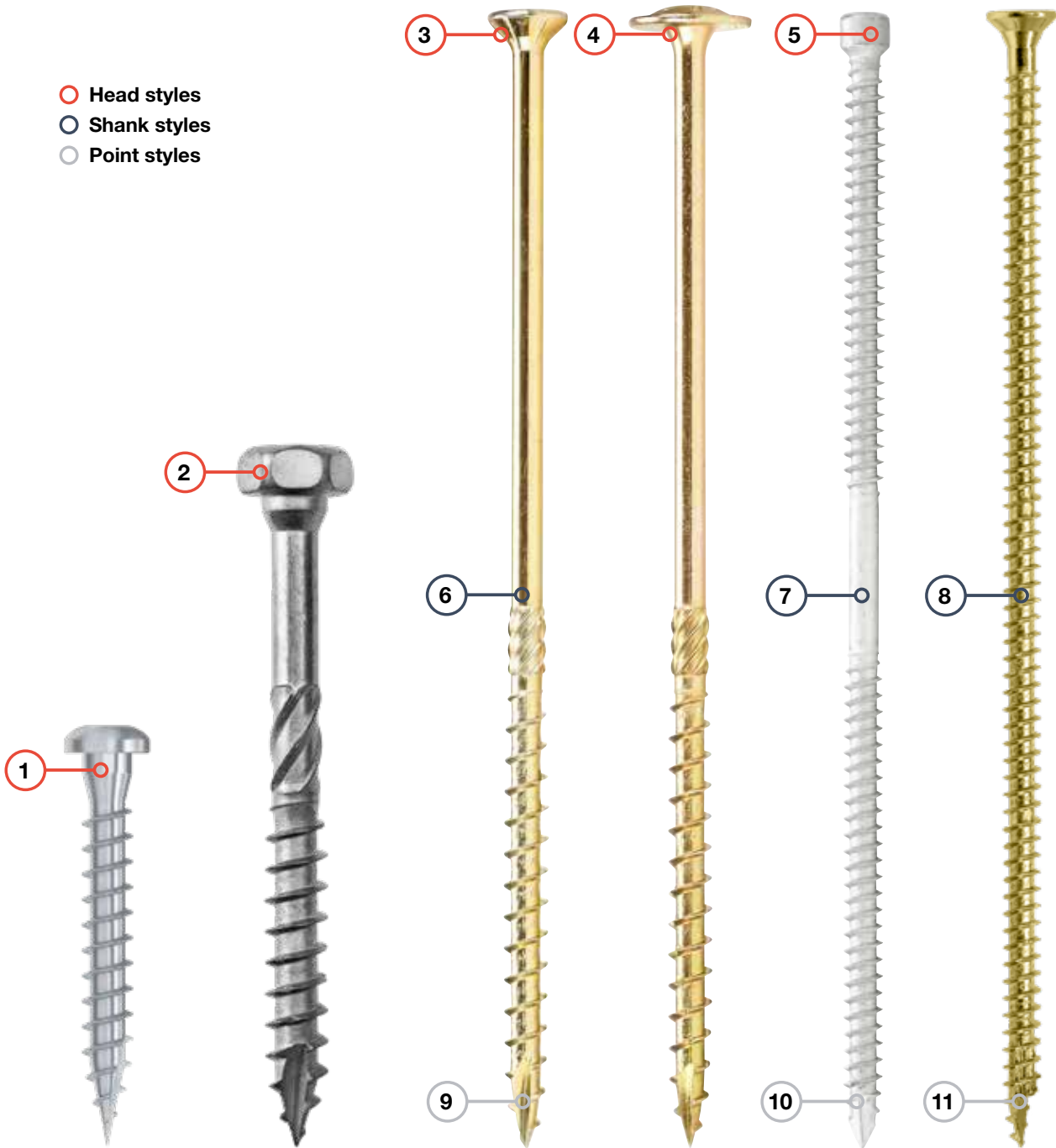

- 1 Conical shape** under the head for maximum fit in metal holes
- 2 Hex-head** with 6-lobe recess allows for the convenience of driving with either a hex-driver bit or 6-lobe driver bit
- 3 Countersunk head** with underhead nibs creates a flush finish
- 4 Washer head** creates high pull-through resistance
- 5 Small cylinder head** sinks into the wood allowing for hidden assemblies
- 6 Partial thread** with milling thread reduces the drive-in torque
- 7 Double thread** with differentiated thread pitch creates a clamping effect that pulls the wood members together
- 8 Full thread** for excellent pull-out values and high load-bearing capacities
- 9 Type 17 cut point** reduces the risk of wood splitting during the installation
- 10 Chisel point** allows for skewed installations
- 11 Half-cut point** gives low installation torque and no pre-drilling is required

# Fastener Types and Sizes

## Solid-Drive™ Fastener Types and Sizes



### ETA-21/0670

The Solid-Drive range consists of 22 high-quality fasteners designed to meet the demands of structural wood constructions.

The first 11 screws shown in this window are approved according to ETA-21/0670, which gives them a number of benefits, that are presented in the table on page 18.

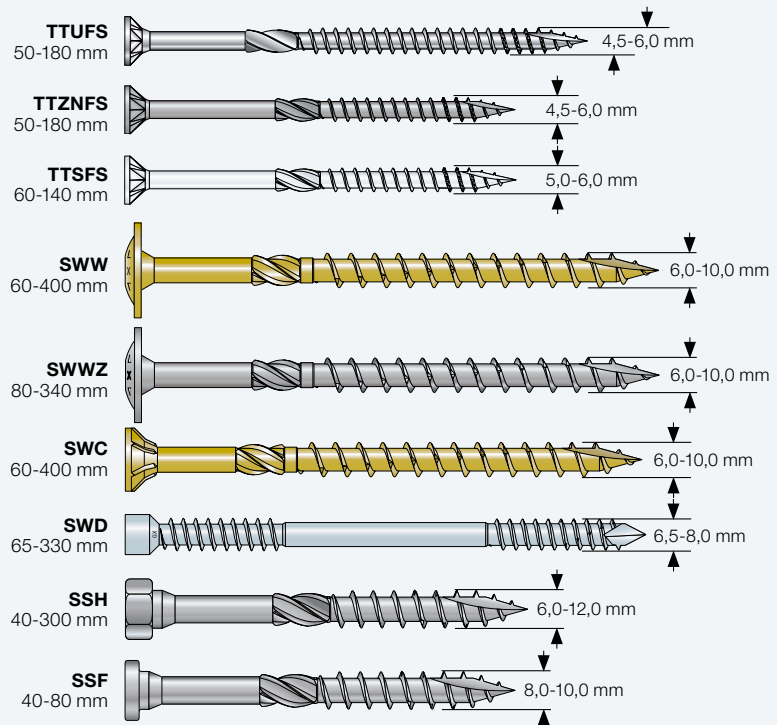

### ETA-13/0796

The ESCR range consists of a number of full threaded screws as well as double threaded timber screws, that are approved according to ETA-13/0796.

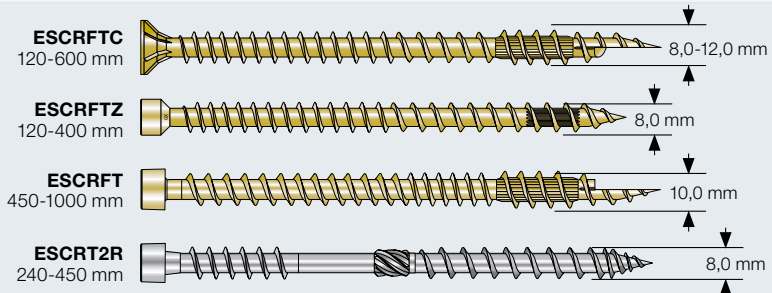

### ETA-04/0013

Our CNA connector nails and CSA connector screws are ETA-approved according to ETA-04/0013.

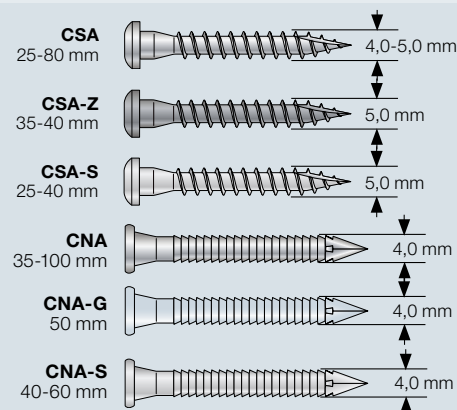

### EN14592

Furthermore, the Solid-Drive range includes three wood-framing screws which are CE-marked according to EN14592.

With this range we give you precision engineered to meet any demand.

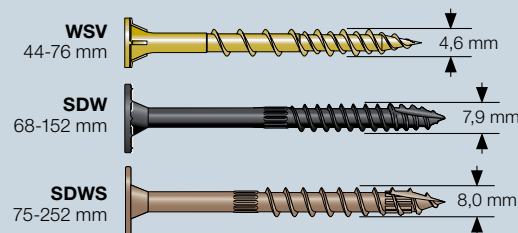



# Application Matrix

Product	Environment			Chapter 3 Timber to Timber						Chapter 4 Steel to Timber	Chapter 5 Boards to Timber
	Indoor	Outdoor	Severe	Solid Timber	Glulam				CLT		
					General Glulam	Inclined	Cross Pairs	Reinforce- ment			
TTUFS	●			● (p. 74)	● (p. 119)				● (p. 183)	○*	● (p. 258)
TTZNFS		●		● (p. 74)	● (p. 119)				●	○*	● (p. 260)
TTSFS			●	● (p. 74)	● (p. 119)				●	○*	● (p. 262)
SWW	●			● (p. 81)	● (p. 126)				● (p. 184)	○	○
SWWZ		●		● (p. 81)	● (p. 126)				●	○	○
SWC	●			● (p. 89)	● (p. 134)				● (p. 187)	○*	○
SWD	●			● (p. 94)	● (p. 139)	● (p. 160)	● (p. 165)		● (p. 191)		
SSH		●		○ (p. 97)	○ (p. 142)					● (p. 230)	
SSF		●		○	○					● (p. 234)	
ESCRFTC	●			● (p. 102)	● (p. 150)	○	○	● (p. 171)	● (p. 192)	○*	
ESCRFTZ	●			● (p. 102)	● (p. 150)	● (p. 161)	● (p. 166)	●	● (p. 192)		
ESCRFT	●			● (p. 109)	● (p. 145)	● (p. 162)	● (p. 167)	●	● (p. 204)		
ESCRT2R	●										
CSA	●									● (p. 236)	
CSA-Z		●								● (p. 237)	
CSA-S			●							● (p. 237)	
CNA	●									● (p. 239)	
CNA-G		●								● (p. 240)	
CNA-S			●							● (p. 240)	
WSV	●										● (p. 256)
SDW	●			● (p. 112)	● (p. 155)						
SDWS		●		● (p. 112)	● (p. 155)						

● Recommended

○ Suitable (but not always recommended - see Solid Wood)

\* Can be used, but hole in metal needs to be countersunk for full contact with screw head - see page 29.

# ETA-approval

## Benefits of using our ETA-approved fasteners



The ETA-21/0670 describes the properties of our main line of fasteners for structural timber constructions, in depth. For you, the ETA works as documentation that the fasteners have been rigorously tested. This ensures that you can rely on our documentation as the basis for your calculations and specifications of the products.

There are a number of specific advantages when using ETA certified fasteners compared to using fasteners that are CE marked according to a harmonized European standard. The ETA gives you more installation possibilities when using our fasteners.

General Information

### Head-Pull Through ( $F_{head,k}$ )

The declared capacity for head-pull through according to ETA-21/0670 is limited to a maximal displacement of 15 mm. According to EN 14592 there are no limitations and it is common to declare  $F_{max}$  values which normally allows a displacement up to 25-35 mm in the structure.

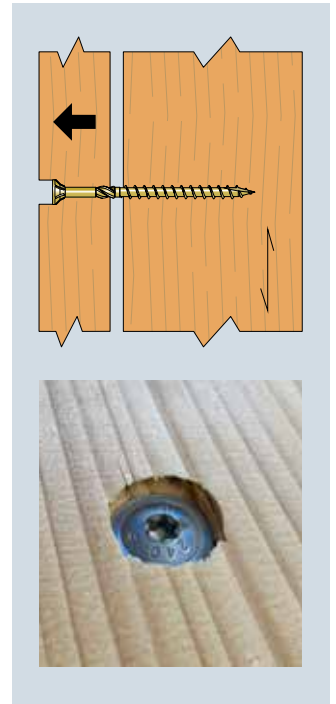
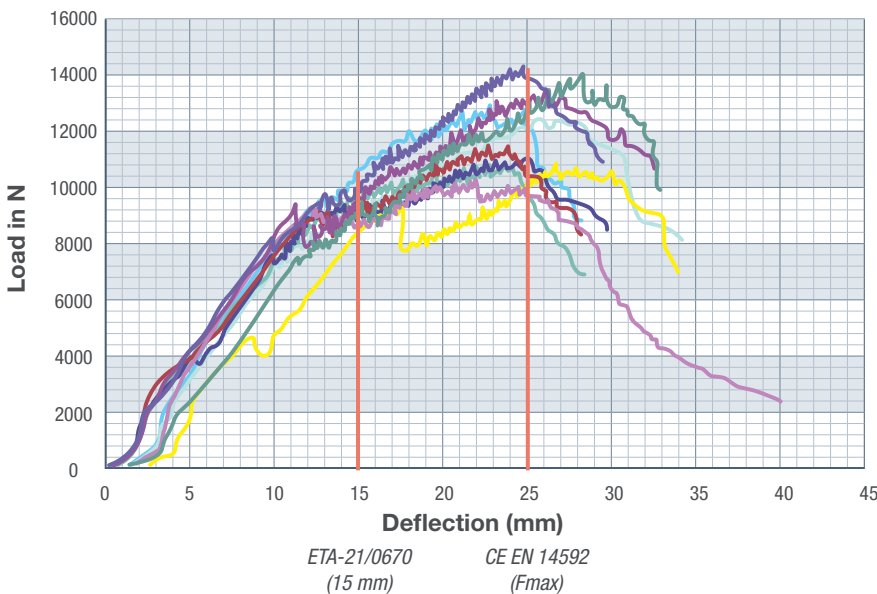

### Yield Moment ( $M_{y,k}$ )

Yield moment capacities are based on the requirement in the EAD 130118-01-0603. The yield moment is the value at the plastic bending angle  $\alpha = 45/d^{0.7}$  degrees, the ductility of our ETA approved fasteners have also been tested by a 20 degree higher bending angle than the standard requirement according to EN 14592.

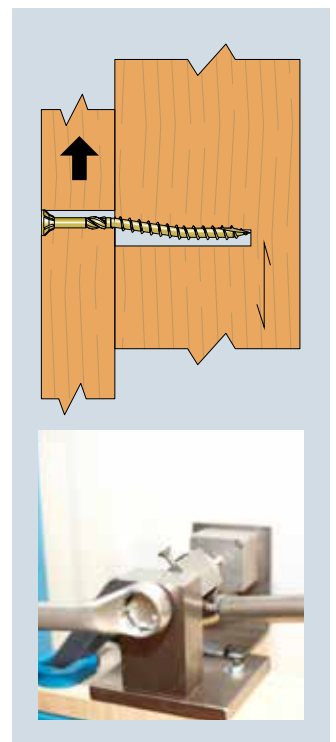
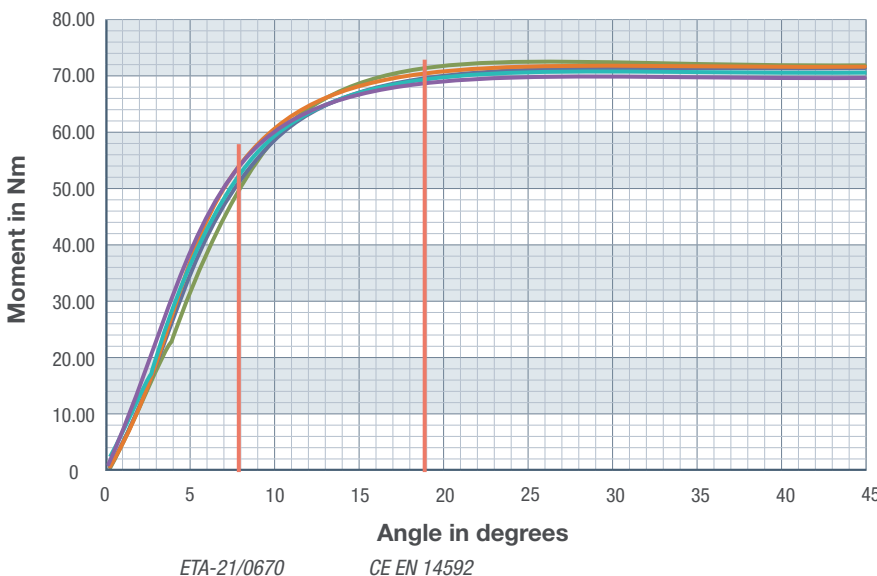

# ETA-approval

## Withdrawal Capacity ( $F_{ax,k}$ )

The withdrawal capacity for the ETA approved fasteners is valid for all grain directions, tangential, radial and parallel (vs. end grain). The number of test specimens are extended in comparison to the standard requirement.

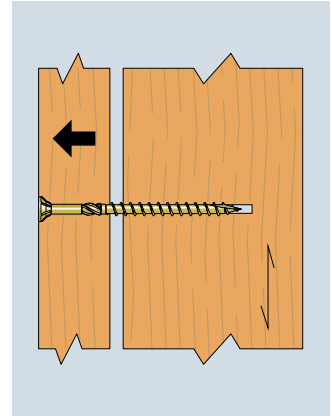
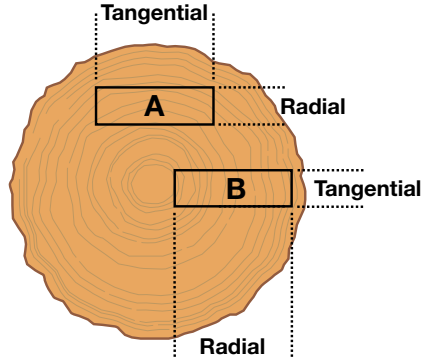

General Information

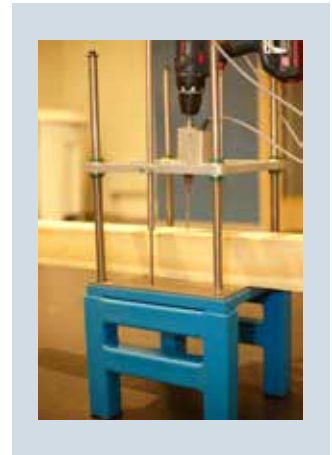
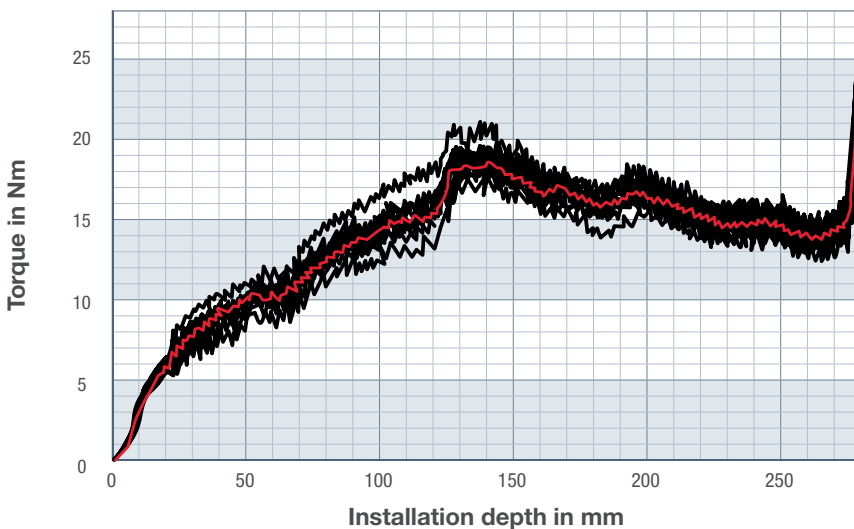
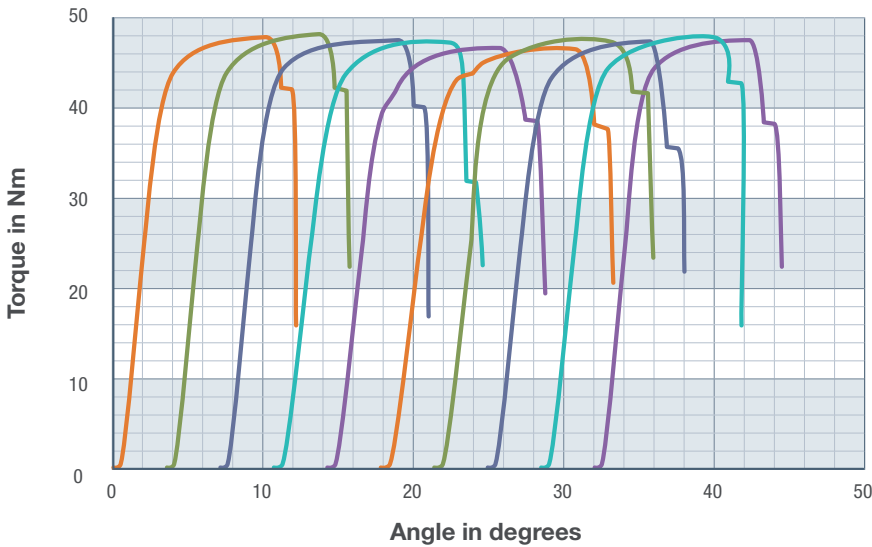

## Insertion Moment ( $F_{tor,k} / R_{tor,mean}$ )

Our ETA approved fasteners have been installed and tested in LVL specimens with a density up to 550 kg/m<sup>3</sup>, the insertion moment was compared against the torsional strength and all screws fulfill the requirement  $f_{tor,k} / R_{tor,mean} > 1,5$ .



## ETA-approval

Comparison of CE certified screws  
acc. to **EN14592** and **Eurocode 5** vs. **ETA-21/0670** and **ETA-13/0796**

Property	EN14592 and Eurocode 5 	ETA-21/0670 	ETA-13/0796 
CLT calculations	Not included	Included in ETA <sup>1</sup>	Included in ETA <sup>1</sup>
LVL calculations	Partially included in EC5	Included in ETA <sup>2</sup>	Included in ETA <sup>2</sup>
Calculations for rafter insulation	Not included	Included in ETA <sup>3</sup>	Included in ETA <sup>3</sup>
Withdrawal 0°	Not included	Tested and approved for structural installations in any directions vs the grain direction 0-90°. (SWD screws with 8 mm thread diameter approved between 15-90°.)	Tested and approved for structural installations in any directions vs the grain direction 0-90°.
Pre-drilling	Mandatory from d = 8 mm	Not required	Not required
Bending angle / ductility	Limited by 45/d <sup>0.7</sup> degrees	Tested and approved for a 20° higher bending angle than the standard.	Tested and approved for a 20° higher bending angle than the standard.
Space and edge distance	EC5 = (without examination)	Improved space and edge distance for SWD screws. The reduced values gives the opportunity to add more fasteners to the connection on a smaller area and get closer to the edges without pre-drilling.	Improved space and edge distance for ESCRFTC, ESCRFTZ, ESCRFT screws. The reduced values gives the opportunity to add more fasteners to the connection on a smaller area and get closer to the edges without pre-drilling.
Extended test program	10 test specimens per characteristic parameter	Extended number of test specimens per characteristic parameter	Extended number of test specimens per characteristic parameter
Displacement requirement head pull-through	No limitations	Test stopped at max. 15 mm displacement	No limitations

<sup>1</sup> Solid-Drive screws that are included in ETA-21/0670 and ETA-13/0796 can be used for CLT applications, you find all formulas for making the calculations in our ETA approval and also the space and edge distances. The quickest and easiest way for making CLT calculations is to use our software Solidwood where you in four simple steps can get load values based on your application.

<sup>2</sup> In the ETA-21/0670 and ETA-13/0796 you find support for LVL (softwood) calculations for all Solid-Drive Fasteners.

<sup>3</sup> Screws with diameters between 6 mm and 12 mm may also be used for the fixing of thermal insulation material on rafters and on vertical facades, you can find the calculations in the ETA.

### Terms and Conditions

Simpson Strong-Tie does not guarantee the performance or safety of any products that have been modified, improperly installed or not used in accordance with the design and load limits, or other instructions or prerequisites provided in this catalogue or elsewhere. Simpson Strong-Tie shall not be liable for any indirect or consequential damages such as commercial disturbance or loss of profits, except when such damages have been caused by Simpson Strong-Tie's intent or gross negligence. Simpson Strong-Tie does not take responsibility for any printing errors. Only the Technical Guide with the latest date is valid. It is the user's responsibility to ensure that he/she uses the latest version.



# Calculation and Design of Screw Connections

## Calculation and Design

In the following pages we will go through the basics of how to calculate and design screw connections. There are a number of factors to take into consideration when calculating your screw

connections. For example the direction and duration of the loads. The characteristics of the wood and other materials and of course the impact of the environment in which the connection is placed.

## Load Duration Classes

The design load capacity depends on the duration of the load. In the case of a combination of loads with different load durations, the class of the load with the shortest duration is selected.

For example, in the case of a load combination of dead weight (load duration class P) and wind load (load duration class S), the load duration is S.

Load Duration		
Load duration	Duration of characteristic load	
<b>P</b>	Permanent	More than 10 years. For example, weight of property
<b>L</b>	Long term	6 months - 10 years. For example, useful load in warehouse
<b>M</b>	Medium	1 week - 6 months. For example, payload and snow load
<b>S</b>	Short term	Less than 1 week. For example, wind load
<b>I</b>	Momentary	For example, accident load

## Design Load Capacities

The design load carrying capacity  $F_{R,d}$  is calculated by correcting the characteristic load carrying capacity  $F_{R,k}$  by the factor  $k_{mod}$  and  $\gamma_m$ .

$$F_{R,d} = k_{mod} \frac{F_{R,k}}{\gamma_m}$$

$\gamma_m$  is the partial factor for a material property.

$k_{mod}$  is a modification factor taking into account the effect of the duration of load and moisture content.

**Note: The values given in this document are the characteristic capacities except when other is communicated.**

Service Class	$k_{mod}$				
	Load Duration				
	P	L	M	S	I
1	0,6	0,7	0,8	0,9	1,1
2	0,6	0,7	0,8	0,9	1,1
3	0,5	0,55	0,65	0,7	0,9

$\gamma_m$	
Solid wood	1,3
Glulam	1,3
CLT	1,3

## Service Classes

When connecting timber structures, the dimensional load-bearing capacity is influenced by the effect of moisture. The requirements for

the corrosion protection of the fittings depend on the climate class in which the fastener is used.

Service Class	Description	Examples
1	Moisture content in the materials corresponding to a temperature of 20°C and the relative humidity of the surrounding air only exceeding 65% for a few weeks per year.	Warm roof, intermediate floors, timber frame walls - internal and party walls.
2	Moisture content in the materials corresponding to a temperature of 20°C and the relative humidity of the surrounding air only exceeding 85% for a few weeks per year.	Cold roof, ground floors, timber frame walls - external walls where member is protected from direct wetting.
3	Climatic conditions leading to higher moisture contents than in service class 2.	External uses - fully exposed.

Service classes according to Eurocode 5: Definition of the service classes environment are given within the EN1995-1-1

# Timber Grades

## Timber Grades - Characteristic Densities ( $k_{dens}$ factor)

In this document, all values for **solid timber** are given for a C24 timber.

In case of **glulam** they are given for a GL24h glulam.

In case of **CLT**, the characteristic density used is  $\rho_k = 350 \text{ kg/m}^3$ .

For **boards**, the characteristic density used is  $\rho_k = 380 \text{ kg/m}^3$ .

For **plywood**, the characteristic density used is  $\rho_k = 490 \text{ kg/m}^3$ .

It is possible to change the timber class by multiplying the characteristic values by the  $k_{dens}$  factor.

$$k_{dens} = \left( \frac{\rho_k}{\rho_a} \right)^{0.8}$$

with:

$\rho_k$  the target characteristic density according to EN 338

$\rho_a$  the characteristic density of the timber according to EN 338

so, for solid timber the equation is:

$$k_{dens} = \left( \frac{\rho_k}{350} \right)^{0.8}$$



In this catalogue you will find the characteristic values for our fasteners in C24 solid timber and GL24h glulam.

For all other timber- and glulam grades you will find the characteristic values in Solid Wood

[solidwood.strongtie.eu](http://solidwood.strongtie.eu)

### Solid Timber -

The table below allows to go from C24 to other solid timber classes:

Timber grade	C14	C16	C18	C20	C22	C24	C27	C30	C35	C40
$\rho_k$ [kg/m <sup>3</sup> ]	290	310	320	330	340	350	360	380	390	400
$k_{dens}$ [-]	0,86	0,91	0,93	0,95	0,98	1,00	1,02	1,07	1,09	1,11

For glulam the equation is:

$$k_{dens} = \left( \frac{\rho_k}{385} \right)^{0.8}$$

### Glulam -

The table below allows to go from GL24h to other glulam classes:

Glulam grade	GL20h	GL20c	GL22h	GL22c	GL24h	GL24c	GL26h	GL26c	GL28h	GL28c	GL30h	GL30c	GL32h	GL32c
$\rho_k$ [kg/m <sup>3</sup> ]	340	355	370	355	385	365	405	385	425	390	430	390	440	400
$k_{dens}$ [-]	0,91	0,94	0,97	0,94	1,00	0,96	1,04	1,00	1,08	1,01	1,09	1,01	1,11	1,03

### Difference between GLT c and GLT h

Glued Laminated Timber made from one type wood grade planks is indicated with symbol h. The c mark indicate beams with different layers, where the wood of a better quality is used in the outer layers, while the planks of a lower class are used inside.

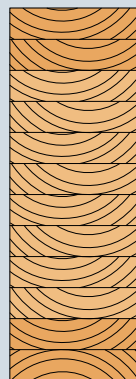

GLT c



GLT h

## Correction Factors / Pre-Drilling Wood

### Correction Factors

#### Effective number

The strength  $R_{k,n}$  of a group of screws can be calculated by multiplying the strength of a single screw by  $n_{ef}$ :  $R_{k,n} = n_{ef} \times R_k$

#### Total number of fasteners - Tensile forces (or number of cross-screwed pairs)

Total load capacity is obtained by multiplying table values by factors on the left. The same table is used for  $n_{ef}$  number of cross-bolted screw pairs when sizing with SWD  $n_{ef} = n^{0,9}$ .

In case of tensile forces									
Number of fasteners $n$	1	2	3	4	5	6	7	8	9
Effective number of fasteners $n_{ef}$	1,0	1,9	2,7	3,5	4,3	5,0	5,8	6,5	7,2

#### Shear loading

Spacing	$k_{eff}$
$a_1 \geq 14d$	1,0
$a_1 = 10d$	0,85
$a_1 = 7d$	0,7
$a_1 = 4d$	0,5

Screws subject to shear loading:

TTUFS, TTZNFS, TTSFS, SSH, SWC, SWW, SWWZ, WSV

$d=5$  and  $6$

On the same wood grain:  $n_{ef} = n_{keff}$

Staggered arrangement of  $1x d$ :  $n_{ef} = n$

Perpendicular to the grain:  $n_{ef} = n$

Screws subject to shear loading:

SWW, SWWZ, SWC, SWD, SSH, SSF  $d \geq 8$

On the same wood grain:  $n_{ef} = \min \left( n^{0,9} \times 4 \sqrt{\frac{a_1}{13d}} \right)$

Perpendicular to the grain:  $n_{ef} = n$

### Recommended Pre-Drilling Hole Diameter Wood

All ETA approved fasteners can be driven into the wood with or without pre-drilling as long as the characteristic density of the member not exceed  $550 \text{ kg/m}^3$  for carbon steel, and  $500 \text{ kg/m}^3$  for stainless steel. The benefits of pre-drilling is reduced space & edge distances and increased shear capacity of the connection.

#### Recommended max. pre-drill hole diameter wood

Fastener	Fastener diameter d						
	Ø4,5	Ø5,0	Ø6,0	Ø6,5	Ø8,0	Ø10,0	Ø12,0
TTUFS/TTZNFS	Ø2,5	Ø3,0	Ø3,5	-	-	-	-
TTSFS	-	Ø3,0	Ø3,5	-	-	-	-
TTUFP/TTZNFP	-	Ø3,0	Ø3,5	-	-	-	-
SWW	-	-	Ø3,5	-	Ø5,0	Ø6,0	-
SWC	-	-	Ø3,5	-	Ø5,0	Ø6,0	-
SWD	-	-	-	Ø3,5	Ø5,0	-	-
SSH/SSF	-	-	Ø3,5	-	Ø5,0	Ø6,0	Ø6,5
ESCRFC/ESCRFTZ/ESCRFT	-	-	Ø3,5	-	Ø5,0	Ø6,0	Ø6,5
ESCRT2R	-	-	-	-	Ø5,0	-	-
SDW/SDWS	-	-	-	-	Ø5,0	-	-

# Space and Edge Distance

## Space and Edge Distance

Edge and centre space distances for the specific applications are given in each chapter. Below you find the general values.

Edge & centre distances (All screws except SWD, ESCRFTZ, ESCRFT, ESCRFTC) depend on a number of factors. These include:

1. The outer diameter of the screw  $d$
2. Direction of force
3. Angle between transverse force direction and wood fibre direction  $\alpha$ . This must be checked per piece of wood as the fibre direction may differ.

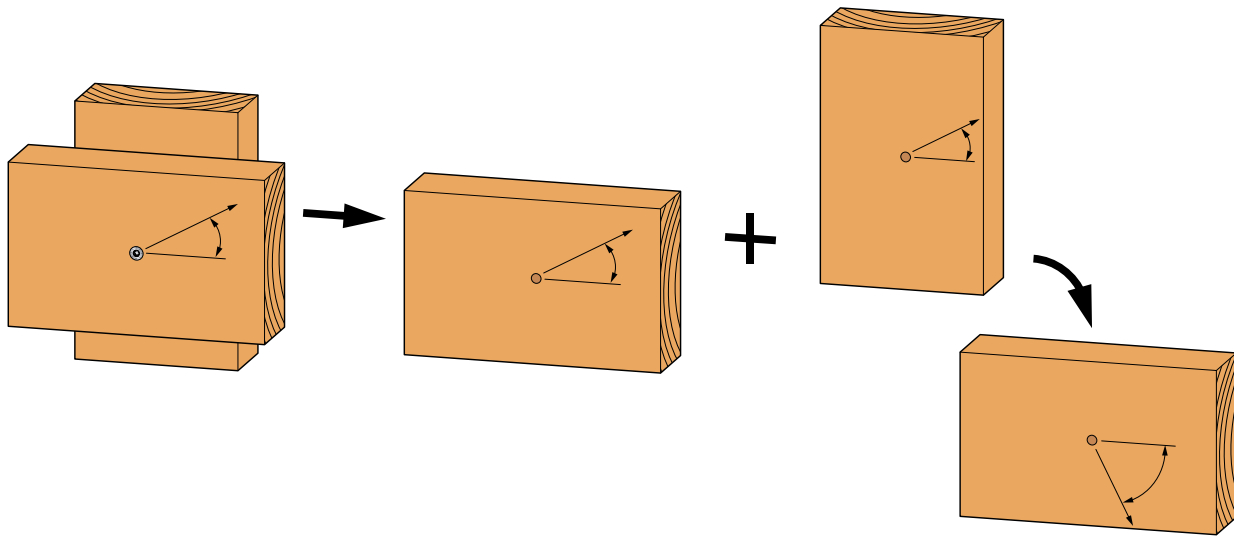
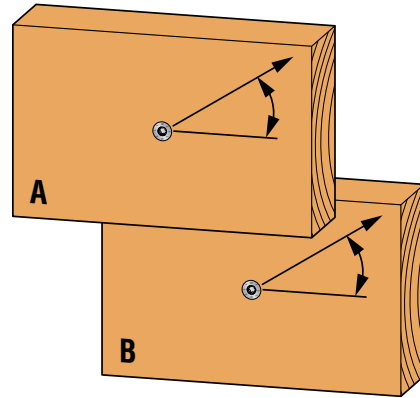

Minimum distances from the unloaded edge perpendicular to the grain may be reduced to  $a_{4,c} = 3 \times d$  if the spacing parallel to the grain ( $a_1$ ) and the end distance ( $a_{3,u}$ ) is at least  $25 \times d$ .

For screws the minimum width / thickness for structural member shall be in accordance with:

Screw diameter	$d < 8 \text{ mm}$	$d = 8 \text{ mm}$	$d = 10 \text{ mm}$	$d = 12 \text{ mm}$
Minimum thickness $t$ for structural members (mm)	24	30	40	80

Panel to timber Case

Refer to EN 1995-1-1 (Eurocode 5) clause 8.3.1.3, see page 23.

Steel to timber Case

Refer to EN 1995-1-1 (Eurocode 5) clause 8.3.1.4, see page 23.



# Space and Edge Distance

## Minimum Space and Edge Distances - Laterally or Combined Loaded Screws

For screws arranged at angles  $\alpha \leq 90^\circ$  between screw axis and grain direction minimum spacing and distances are defined as follows:

Minimum spacing  $a_1$  or  $a_2$  is defined perpendicular to the fastener axis, minimum end or edge distances  $a_{3,c}$ ,  $a_{3,t}$ ,  $a_{4,c}$  or  $a_{4,t}$  parallel or

perpendicular to the grain, respectively, are defined between the centre of the threaded length (axial loading) or the length (lateral loading) in the respective timber member and the member surface as for axially loaded screws in EN 1995-1-1, Figure 8.11.a.

General Information

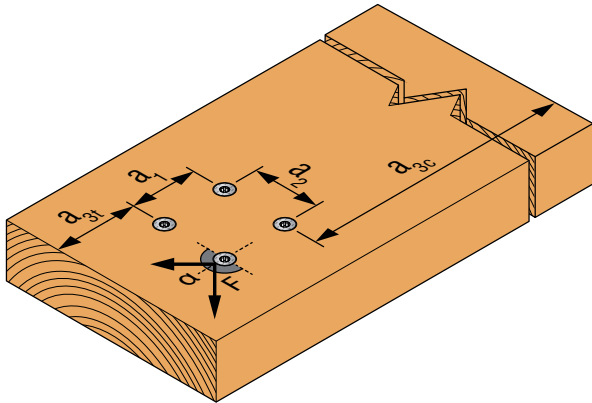

Illustration above shows angle between load direction and grain =  $0^\circ$

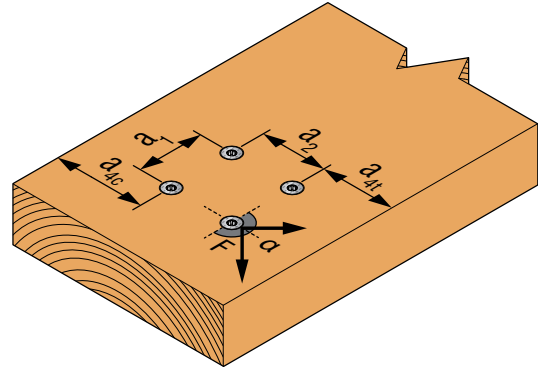
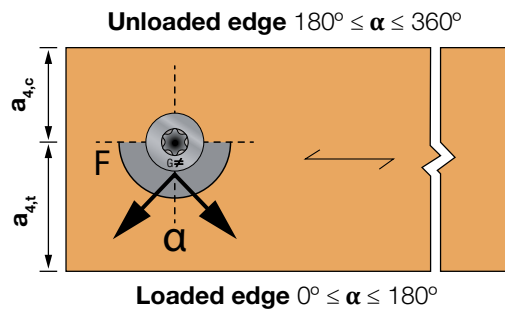
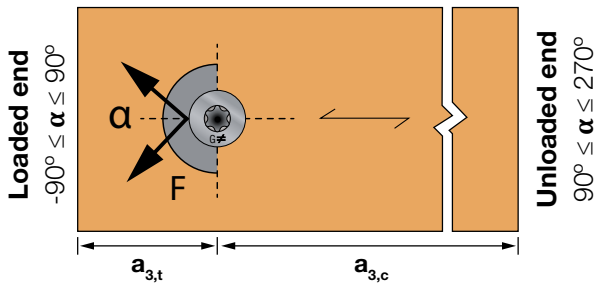

Illustration above shows angle between load direction and grain =  $90^\circ$



C-F-EU-TG-2023-2 (2nd Edition) © 2023 SIMPSON STRONG-TIE COMPANY INC.

Laterally Loaded Screws - Minimum spacing or end/edge distance				
	Angle $\alpha$	Without predrilled holes		With predrilled holes
		$\rho_k \leq 420 \text{ kg/m}^3$	$420 \text{ kg/m}^3 < \rho_k \leq 500 \text{ kg/m}^3$	
$a_1$ Spacing (parallel to grain)	$0^\circ \leq \alpha \leq 360^\circ$	$d < 5 \text{ mm: } (5 + 5 \cos \alpha) d$ $d \geq 5 \text{ mm: } (5 + 7 \cos \alpha) d$	$(7 + 8 \cos \alpha) d$	$(4 +  \cos \alpha ) d$
$a_2$ Spacing (perpendicular to grain)	$0^\circ \leq \alpha \leq 360^\circ$	$5 d$	$7 d$	$(3 +  \sin \alpha ) d$
$a_{3,t}$ Distance (loaded end)	$-90^\circ \leq \alpha \leq 90^\circ$	$(10 + 5 \cos \alpha) d$	$(15 + 5 \cos \alpha) d$	$(7 + 5 \cos \alpha) d$
$a_{3,c}$ Distance (unloaded end)	$90^\circ \leq \alpha \leq 270^\circ$	$10 d$	$15 d$	$7 d$
$a_{4,t}$ Distance (loaded edge)	$0^\circ \leq \alpha \leq 180^\circ$	$d < 5 \text{ mm: } (5 + 2 \sin \alpha) d$ $d \geq 5 \text{ mm: } (5 + 5 \sin \alpha) d$	$d < 5 \text{ mm: } (7 + 2 \sin \alpha) d$ $d \geq 5 \text{ mm: } (7 + 5 \sin \alpha) d$	$d < 5 \text{ mm: } (3 + 2 \sin \alpha) d$ $d \geq 5 \text{ mm: } (3 + 4 \sin \alpha) d$
$a_{4,c}$ Distance (unloaded edge)	$180^\circ \leq \alpha \leq 360^\circ$	$5 d$	$7 d$	$3 d$

Notes:

EN 1995-1-1 (Eurocode 5) clause 8.3.1.2, table 8.2

For "Board to Timber" case, the space distances in the timber element can be multiplied by a factor 0.85

For "Steel to Timber" case, the space distances in the timber element can be multiplied by a factor 0.7

$d$  = Outer thread diameter of the screw

$\rho_k$  = characteristic timber density in  $\text{kg/m}^3$

For Douglas fir members minimum spacing and distances parallel to the grain shall be increased by 50% if the members not are pre-drilled.

# Space and Edge Distance

## Minimum Space and Edge Distance - Axially Loaded Screws

General Information

Axially Loaded Screws - Minimum spacing or end/edge distance	
$a_1$ Minimum screw spacing parallel to the grain	7 d
$a_2$ Minimum screw spacing perpendicular to the grain	5 d
$a_{1,CG}$ Minimum end distance of the centre of gravity of the threaded part of the screw in the member	10 d
$a_{2,CG}$ Minimum edge distance of the centre of gravity of the threaded part of the screw in the member	4 d

For axially loaded screws installed perpendicular to the surface table 8.6 is used. Note that  $a_{1,CG}$  is shown as  $a_{3,c}$  and  $a_{2,CG}$  is shown as  $a_{4,c}$  on the illustrations for perpendicular installations in the chapter timber to timber. For axially loaded screws  $a_{3,i}$  and  $a_{4,i}$  are not relevant.

- <sup>1)</sup> EN 1995-1-1 (Eurocode 5) clause 8.7.2, table 8.6
- <sup>2)</sup> d = Outer thread diameter of the screw
- <sup>3)</sup> Minimum timber thickness  $t \geq 12$  d

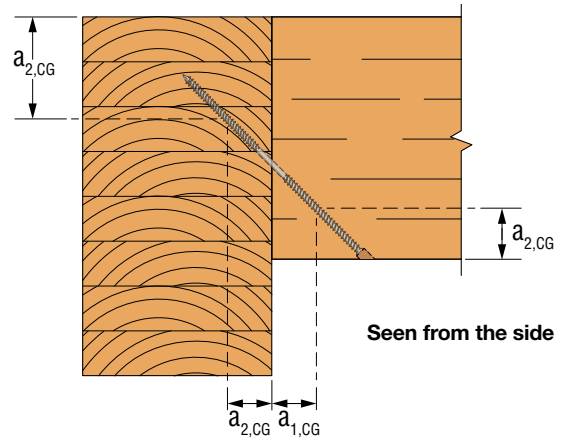

Seen from the side

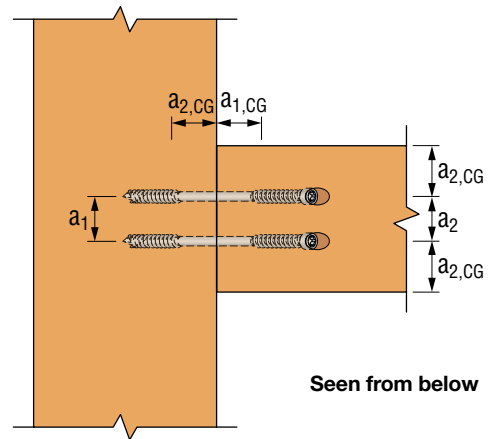

Seen from below

$a_1$  is taken in the header when the screws are distributed along the grain  
 $a_2$  in the joist where the screw are distributed perpendicularly to the grain.

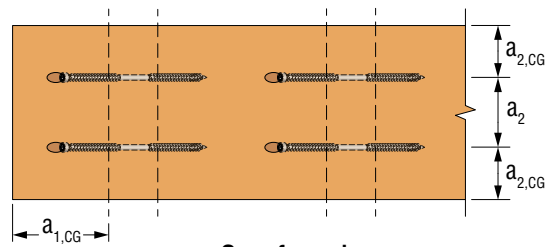
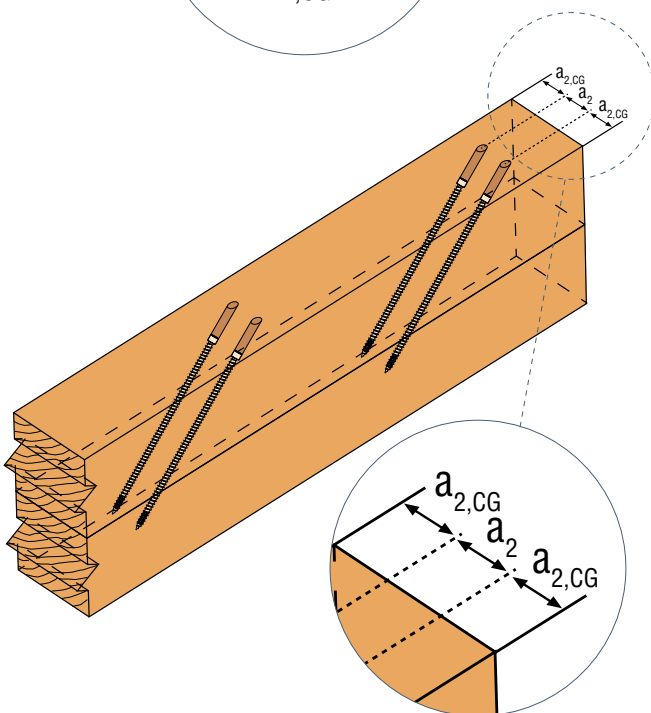
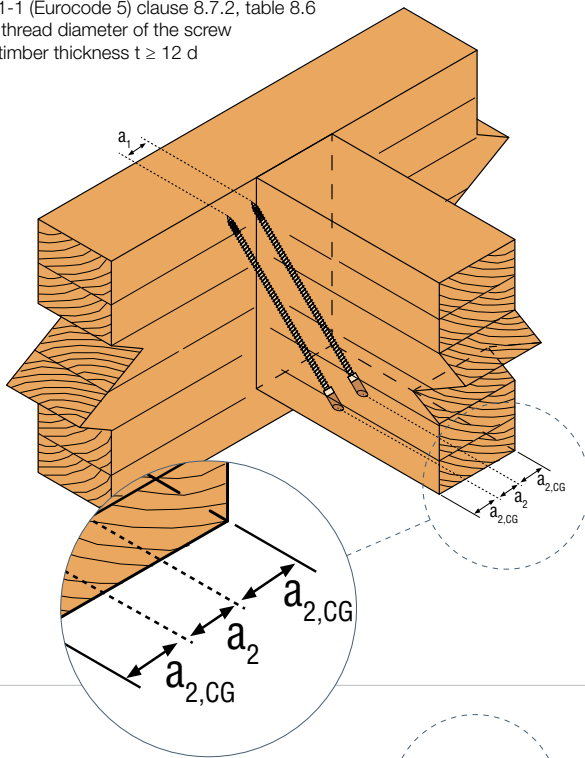

Seen from above

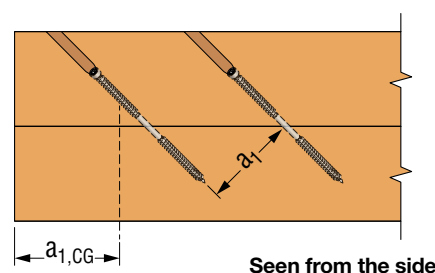

Seen from the side

# Space and Edge Distance

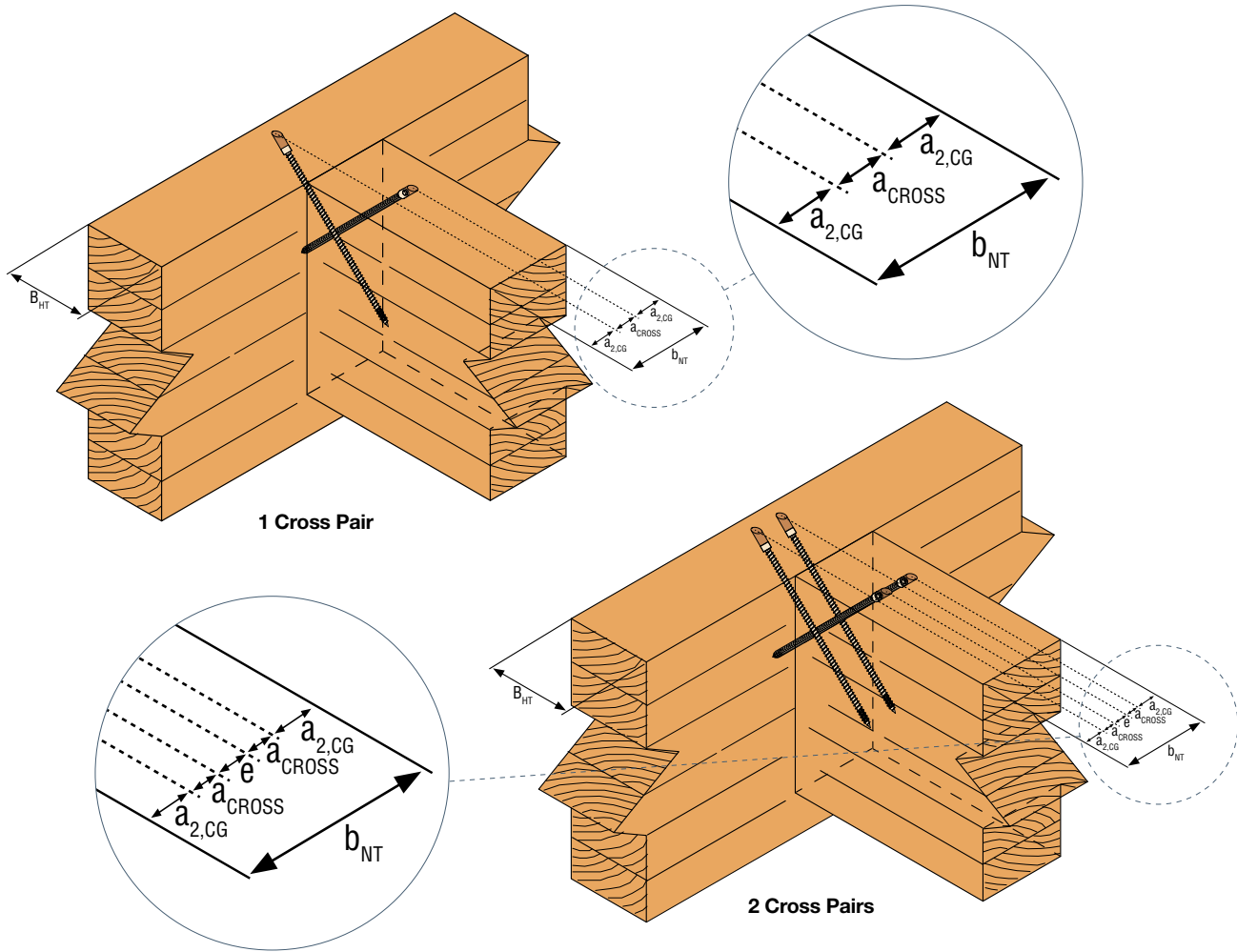

1 Cross Pair

2 Cross Pairs

## Double- & Full Threaded Screws

Alternative Axially Loaded Screws - Minimum spacing or end/edge distance	Screw Family	
	SWD	ESCRFTZ/ESCRFT/ESCRFC
$a_1$ Minimum screw spacing parallel to the grain	10 d	5 d
$a_2$ Minimum screw spacing perpendicular to the grain	3 d	5 d / 3 d* / 2,5 d**
$a_{cross}$ Minimum spacing between crossing screws for a crossed screw couple perpendicular to the grain	1.5 d	1.5 d
$a_{1,CG}$ Minimum end distance of the centre of gravity of the threaded part of the screw in the member	8 d	5 d
$a_{2,CG}$ Minimum edge distance of the centre of gravity of the threaded part of the screw in the member	3 d	4 d

- If  $a_1 * a_2 \geq 21 d^2$  can be kept for every screw
- If  $a_1 * a_2 \geq 25 d^2$  can be kept for every screw

**Notes:**

d = Outer thread diameter of the screw.

For a crossed screw couple in solid timber, glued laminated timber and similar glued products or in laminated veneer lumber the minimum distance between the screws (across) are  $1,5 * d$ . Ensure that the crossed screw threads do not touch each other when being driven into the timber member.

SWD screws has been tested and approved for reduced space and edge distance according to ETA-21/0670, minimum timber thickness  $t \geq 10 d$ , in pre-drilled and non-pre-drilled holes.

ESCRFC/ESCRFT/ESCRFTZ screws has been tested and approved for reduced space and edge distance according to ETA-13/0796, minimum timber thickness  $t \geq 12 d$ , in non-pre-drilled holes.

## Space and Edge Distance

### Space and Edge Distance - Screw Placement $m_i$

Installation of inclined screws require high accuracy to achieve the performance calculated. One of the key elements is the placement of the screw and the insertion angle. In order to achieve this, the distance  $m_i$  must be calculated.

$m_i$  depends of several elements: the length of the screw ( $l$ ), the threaded length ( $l_g$ ), the head diameter of the screw ( $d_h$ ), the angle of insertion ( $\alpha$ ).

This calculation works in case of the screw fully inserted in the timber element. As a reminder half the thread should be in each element.

The minimum distance  $m_i$  is:

$$m_i = (l - l_g / 2 + d_h / 2 * \tan \alpha) * \sin \alpha$$

In this case the head of the screw is flushed to the top face.

If the screw pair is placed so it is in the middle of the height ( $h/2$ ) of the joist or the panel thickness, the equation is:

$$m_i = h / 2 \tan \alpha$$

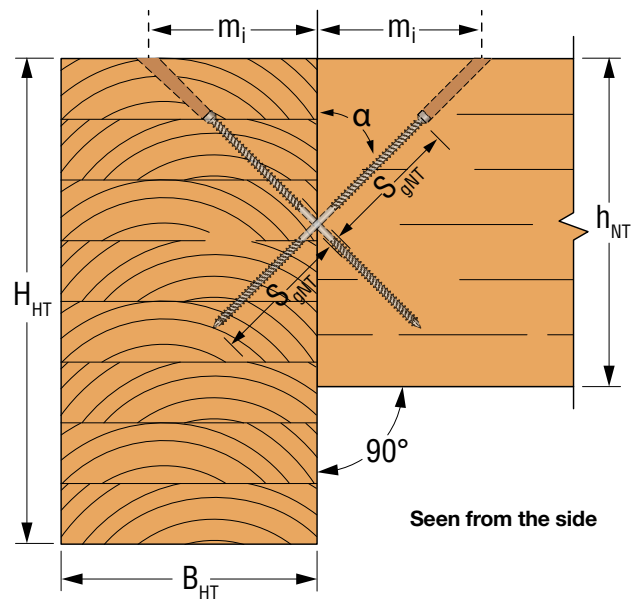
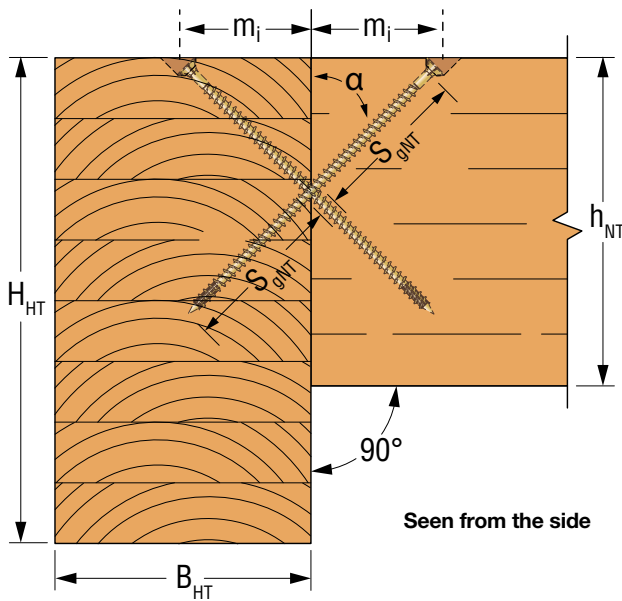

$m_i$  = Distance between the shear plane and the insertion point

$b_{nt}$  = Min. width of the secondary beam in [mm]

$h_{nt}$  = Min. height of the secondary beam in [mm]

$B_{HT}$  = Min. width of the main beam in [mm]

$H_{HT}$  = Min. height of the main beam in [mm]

$S_{gNT}$  = Effective thread length

$\alpha$  = the angle of insertion



## Space and Edge Distance

### Space and Edge Distance CLT

#### CLT - Edge Surface/Narrow Face

Unless specified otherwise in the technical specification (ETA or hEN) of the CLT panels, minimum distances and spacing for laterally or axially loaded screws in non-predrilled holes, in the edge surface of CLT members with a minimum thickness  $t = 10 \times d$  and a minimum penetration depth perpendicular to the edge surface of  $10 \times d$  may be taken as:

Minimum spacing or end/edge distance CLT - Edge surface/Narrow face	
$a_1$ Minimum screw spacing parallel to the CLT plane	10 d
$a_2$ Minimum screw spacing perpendicular to the CLT plane	4 d
$a_{3,t}$ Minimum distance from centre of the screw in timber to the loaded end	12 d
$a_{3,c}$ Minimum distance from centre of the screw in timber to the unloaded end	7 d
$a_{4,t}$ Minimum distance from centre of the screw in timber to the loaded edge	6 d
$a_{4,c}$ Minimum distance from centre of the screw in timber to the unloaded edge	3 d

Compliant with ETA-21/0670

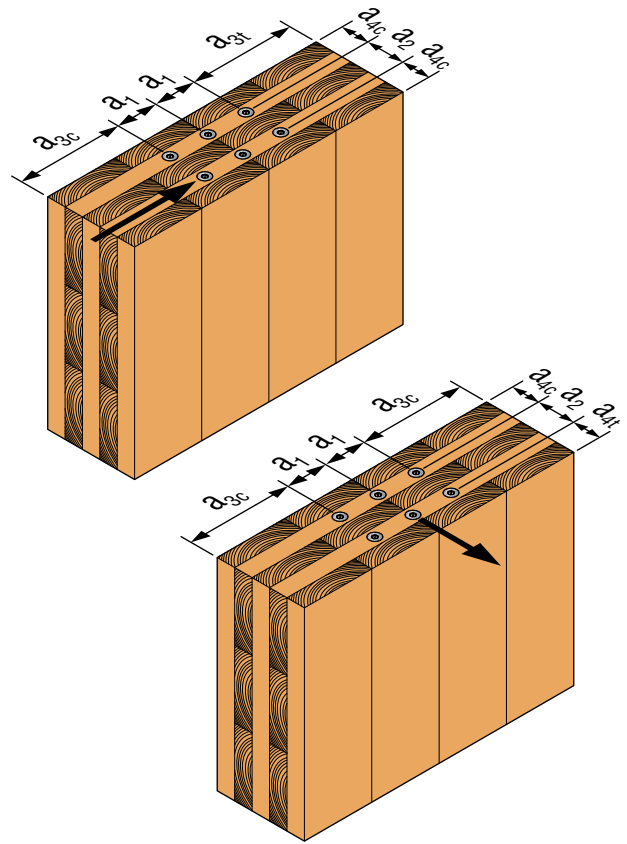

# Space and Edge Distance

## CLT - Plane Surface/Lateral Face

Unless specified otherwise in the technical specification (ETA or hEN) of CLT, minimum distances and spacing for laterally or axially loaded screws in non-predrilled holes, in the wide face of cross laminated timber members with a minimum thickness  $t = 10 \times d$  may be taken as:

Minimum spacing or end/edge distance CLT - Plane surface/Lateral face	
$a_1$ Minimum screw spacing parallel to the grain	4 d
$a_2$ Minimum screw spacing perpendicular to the grain	2.5 d
$a_{3,t}$ Minimum distance from centre of the screw in timber to the loaded end grain	6 d
$a_{3,c}$ Minimum distance from centre of the screw in timber to the unloaded end grain	6 d
$a_{4,t}$ Minimum distance from centre of the screw in timber to the loaded edge	6 d
$a_{4,c}$ Minimum distance from centre of the screw in timber to the unloaded edge	2.5 d

Compliant with ETA-21/0670

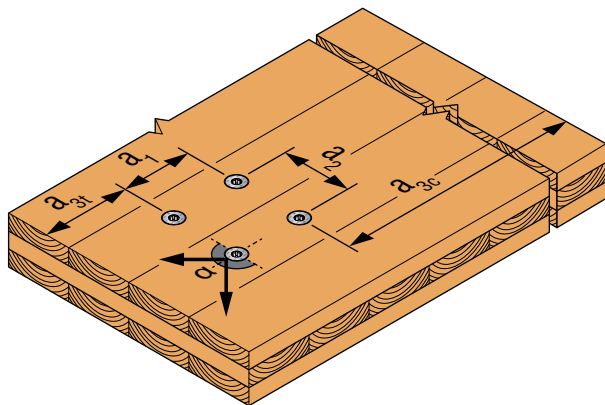

Illustration above shows angle between load direction and grain = 0°

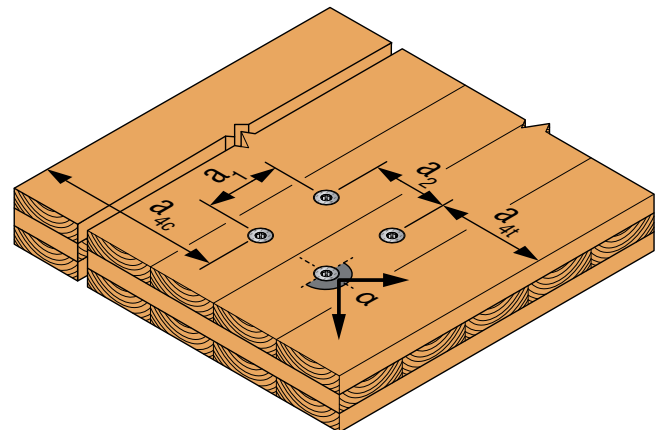
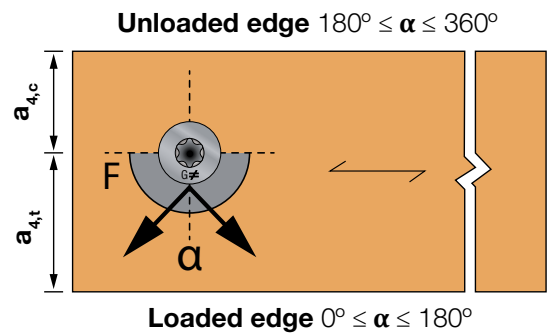
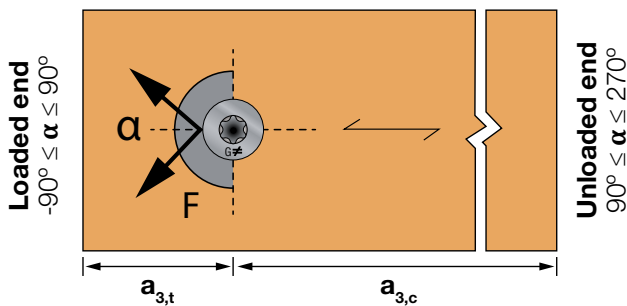

Illustration above shows angle between load direction and grain = 90°



# Hole Diameter Steel / Space and Edge Distance Steel

## Recommended Hole Diameter Steel

Recommended hole diameters in steel plates, all our screws developed for connectors have a cone under the head to ensure the connection between the fastener and the steel. The cone have the same diameter as the outer thread.

If you need a solution where the screw head is flush to the steel surface you can use countersunk screws, below is the recommended hole design for:

All our fasteners are tested and approved together as a system for our connectors.

## Recommended max. hole diameter steel

Fastener	Fastener diameter d					
	Ø4,0	Ø5,0	Ø6,0	Ø8,0	Ø10,0	Ø12,0
SSH	-	-	Ø7,0	Ø9,0	Ø11,0	Ø13,0
SSF	-	-	Ø7,0	Ø9,0	Ø11,0	Ø13,0
CSA	Ø4,0	Ø5,0	-	-	-	-
CNA	Ø5,0	-	Ø7,5	-	-	-

## Recommended hole design in steel countersunk screws (TTUFS/TTZNFS/SWC/ESCRFTC)

Diameter of screw	Ød1 <sub>min</sub>	Ød2 <sub>min</sub>	t <sub>min</sub>
Ø4,5	12,0	5,0	3,0
Ø5,0	13,0	5,5	3,0
Ø6,0	15,5	6,5	3,5
Ø8,0	19,0	9,0	6,0
Ø10,0	22,5	11,0	7,0
Ø12,0	25,0	13,0	7,5

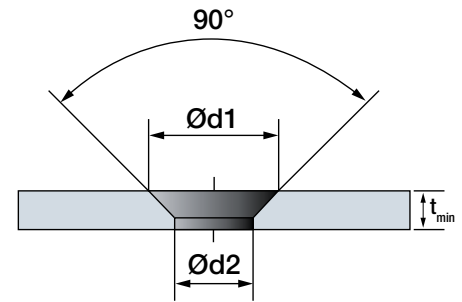

Calculations with Steel to Wood do not take the strength of the steel in consideration, but only the wood and the fastener, see Eurocode 3 for steel plate design.

## Space and Edge Distances Steel

The table below gives the values for pure steel according to Eurocode 3. In steel to timber connections, the limiting factor will always be the timber. See space and edge distances for solid wood on page 22.

a <sub>1</sub> *	a <sub>2</sub> *	e <sub>1</sub> *	e <sub>2</sub> *
2.2d	2.4d	1.2d	1.2d

\*according to EN 1993-1-8 §3.5

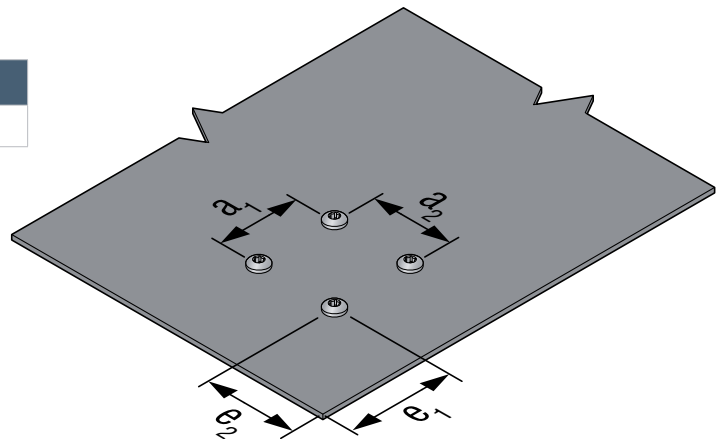

# Screw Resistance

## Screw Resistance

The timber to timber tensile strength  $R_{ax,k}$  includes the following resistances:

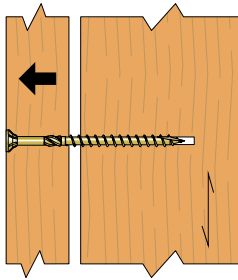

1. Thread pull-out

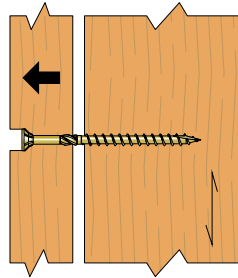

2. Head pull-through

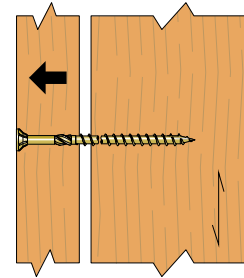

3. Steel under tensile load

These resistances are valid for:

- A timber thickness beneath the head less than or equal to the value  $t_1$  displayed in the adjacent column.
- Screw in the lateral faces of the CLT with an angle from 45 to 90° between the screw axis and the grain of the timber.

- Screw in the strips of the CLT with an angle from 0 to 45° between the screw axis and the grain of the timber. A reduction factor dependent on the angle applies to the axial strength (refer to ETA 21/0670).

For fastening screws (part threaded), dimension  $t_1$  corresponds to the maximum thickness for which the thread is fully inserted pointside in the timber, which ensures effective tightening during installation.

The timber to timber shear strength  $R_{v,α,k}$  includes the following resistances:

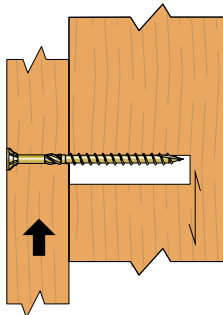

1. Compression timber 2

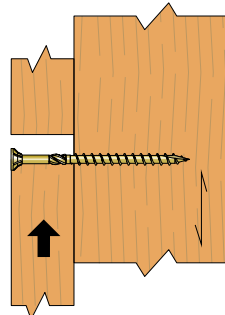

2. Compression timber 1

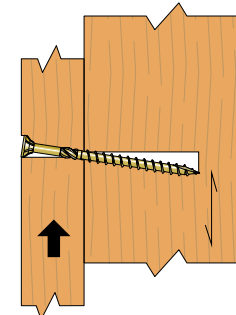

3. Double compression

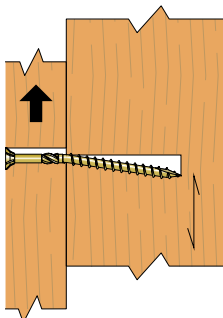

4. Plastic hinge - timber 1

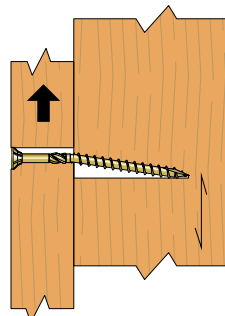

5. Plastic hinge - timber 2

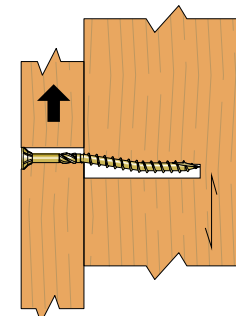

6. Double plastic hinge

Shear strengths are provided for several timber thicknesses beneath the screw head  $t_1$  and for the following configurations:

- Screw in the lateral faces of the CLT with an angle from 45 to 90° between the screw axis and the grain of the timber. Local bearing strength  $f_{h,k}$  is calculated according to EN 1995-1-1:2004+A2:2014.
- Screw in the strips of the CLT with an angle from 0 to 45° between the screw axis and the grain of the timber.

All tensile strengths are given for C24 graded timber.

In case of part threaded screws, the strengths only apply to configurations where the thread does not exceed more than 5 mm into the timber element beneath the screw head to ensure the best possible fastening.

Clause (2) of Part 8.3.1.2 in EN 1995-1-1:204+A2:2014 on the pointside penetration depth does not apply to this calculation.

# Screw Resistance

The steel to timber shear strength  $R_{v,\alpha,k}$  includes the following resistances:

Thin steel  $t_{st} \leq 0.5 d$

Thick steel  $t_{st} \geq d$

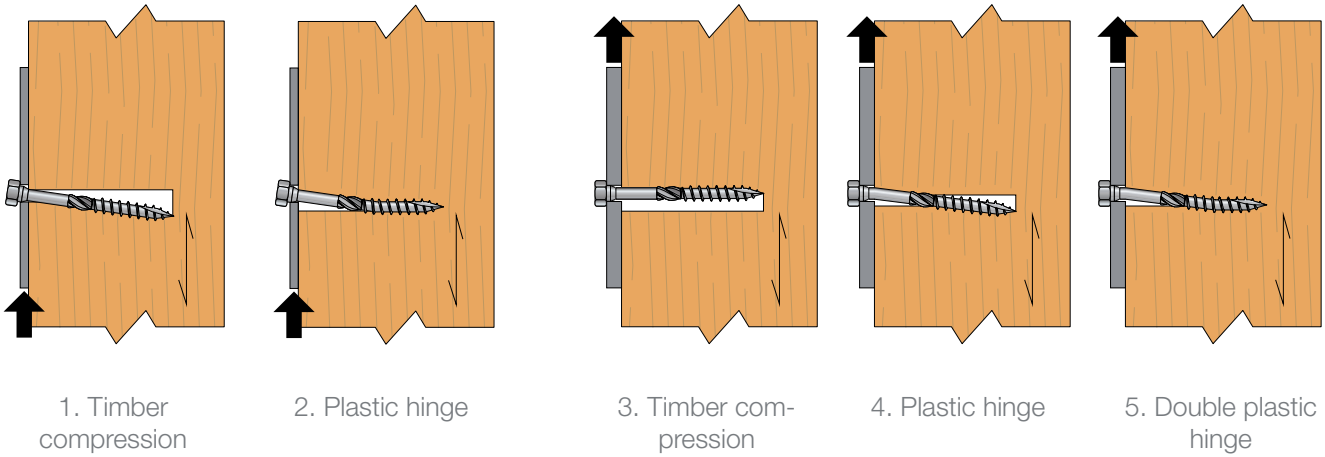

Shear strengths are provided for thick steel ( $t_{st} = d$ ) and thin steel ( $t_{st} = 0.5xd$ ). For the following configurations:

The strength values for intermediate steel thicknesses can be obtained by interpolating the values for thick and thin steel plates.

Local bearing strength  $f_{h,k}$  and the minimum distances/spacings are calculated in the same way as the timber to timber shear strength values seen earlier, according to EN1995-1-1:2004+A2:2014.

These resistances are valid for C24 graded timber and higher.

## Combined or Oblique Stresses

If a screw or group of screws is subjected to axial and lateral forces at the same time (case of oblique stresses), the following combination must be verified:

$$\left( \frac{F_{ax,d,i}}{R_{ax,d,i}} \right)^2 + \left( \frac{F_{v,d,i}}{R_{v,d,i}} \right)^2 \leq 1$$

$F_{ax,d,i}$  and  $F_{v,d,i}$  correspond to the projected oblique stresses respectively according to the screw axis and perpendicular to the screw axis.

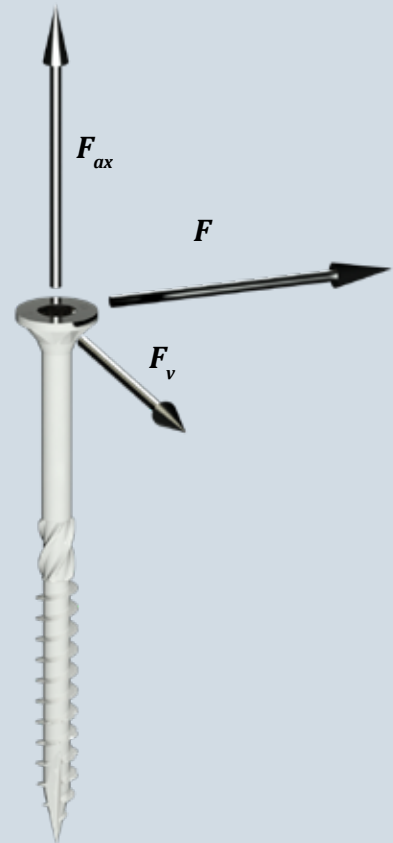



# Fire Calculation for Screws

## Fire Calculation for Screws

Only screws in tension may be justified to fire. So we generally choose fully threaded screws or double threaded screws.

### General information

As hidden connectors, screws are also placed in the middle of the timber, the way to calculate is mainly based on the edge distances. EN1995-1-2 (Eurocode 5 Part 2) is the main document that explain it.

We need to check that :

$$E_{d,fi} \leq R_{d,30,fi} = \eta \times \frac{R_{20}}{\gamma_{M,fi}} = \eta \times k_{fi} \times \frac{R_{ax,k}}{\gamma_{M,fi}}$$

With :

- $E_{d,fi}$  = The load under fire.
- $R_{d,fi}$  = The resistance under fire.
- $\eta$  = Conversion factor.
- $R_{20}$  = 20% fractal of the resistance capacity.
- $\gamma_{M,fi}$  = Partial factor of timber in case of fire (equal to 1).
- $k_{fi}$  = factor to go from the 20% fractal to the 5% fractal for tension loaded connection.
- $R_{ax,k}$  = characteristic capacity of the screw in tension.

$\eta$  depends on the edge distance  $a_1$  (see drawing for the definition of  $a_1$  drawing).

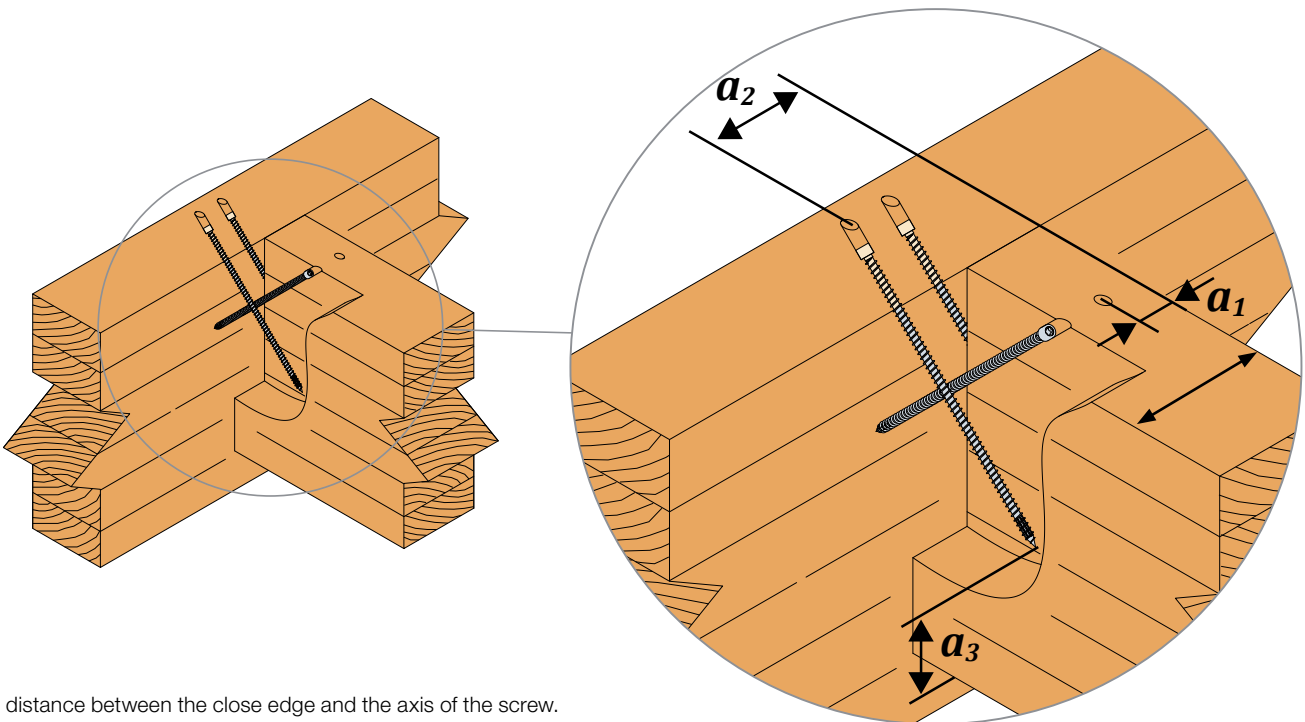

- $a_1$  : distance between the close edge and the axis of the screw.
- $a_2$  : distance between the far edge and the axis of the screw.
- $a_3$  : distance between the close edge and the point of the screw.

# Fire Calculation for Screws

The curve below allows to find the  $\eta$  value.

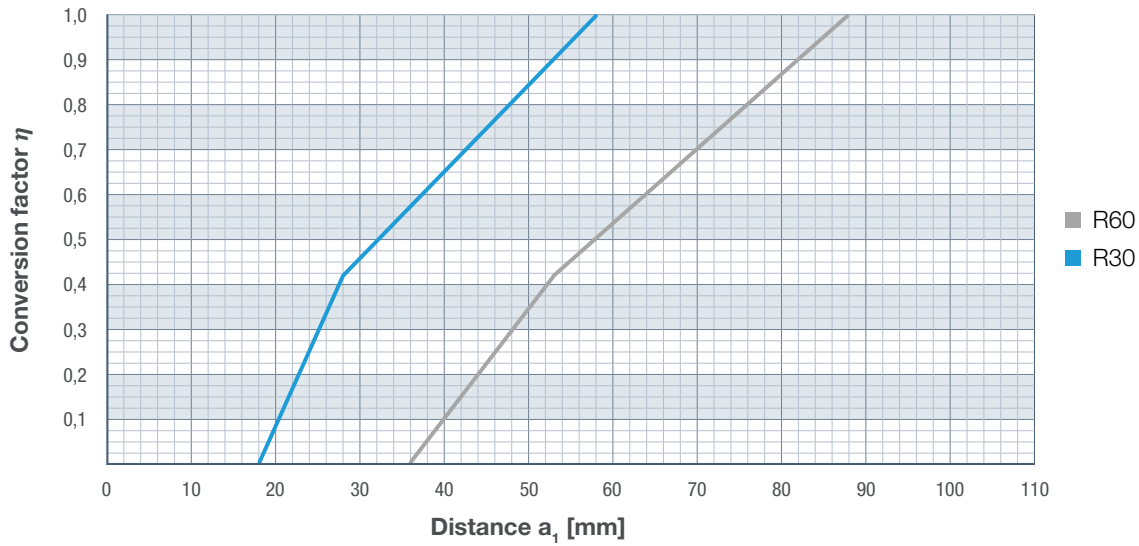

General Information

Note: the graph above is only valid for  $a_2 \geq a_1 + 40$  and  $a_3 \geq a_1 + 20$ .  
if  $a_2 \geq a_1$  and  $a_3 \geq a_1 + 20$  the graph below must be used:

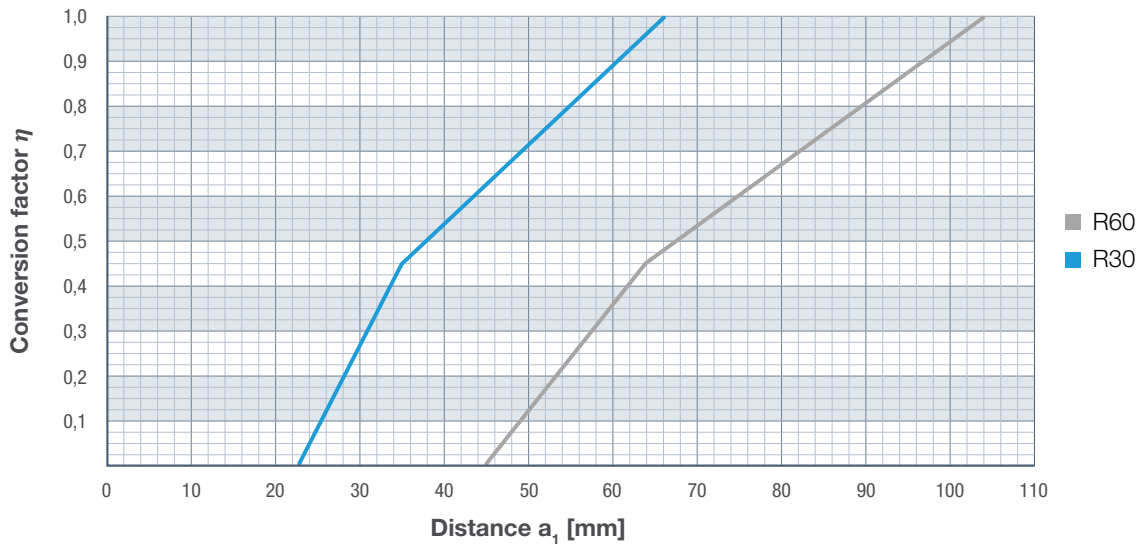

Note: the equation is given below and in EN1995-1-2 6.4 (6.11).

$$\eta = \begin{cases} 0 & \text{for } a_1 \leq 0,6 t_{d,fi} & \text{(a)} \\ \frac{0,44 a_1 - 0,264 t_{d,fi}}{0,2 t_{d,fi} + 5} & \text{for } 0,6 t_{d,fi} \leq a_1 \leq 0,8 t_{d,fi} + 5 & \text{(b)} \\ \frac{0,56 a_1 - 0,36 t_{d,fi} + 7,32}{0,2 t_{d,fi} + 23} & \text{for } 0,8 t_{d,fi} + 5 \leq a_1 \leq t_{d,fi} + 28 & \text{(c)} \\ 1,0 & \text{for } a_1 \geq t_{d,fi} + 28 & \text{(d)} \end{cases}$$

The gap between the beams must be reduced at maximum. The edge distance must be checked both, in fire condition and in cold condition.

# Fire Calculation for Screws



## Example of calculation.

### Hypothesis:

- Used screw: ESCRFTZ8.0x300
- Half of the thread is in each element
- $a_1 = 40 \text{ mm}$ ,  $a_2 = 85 \text{ mm}$ ,  $a_3 = 60 \text{ mm}$
- Characteristic capacity of the screw in tension in cold condition :  $R_{ax,k} = 14.67 \text{ kN}$
- Calculation of the capacity after 30 minutes of fire

### Calculation of the capacity:

- The graph below must be used because of the distance  $a_1$ ,  $a_2$  and  $a_3$
- So we got  $\eta \approx 0.65$
- The tension capacity of the screw after half an hour in fire condition is:

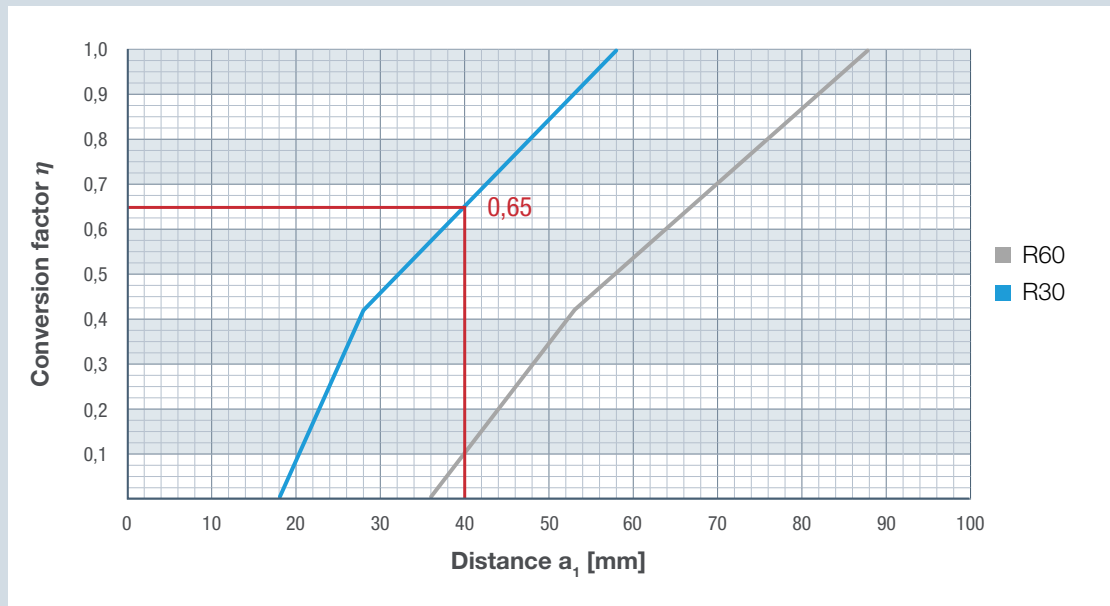

$$R_{d,fi} = \eta \times \frac{R_{20}}{\gamma_{M,fi}} = \eta \times k_{fi} \times \frac{R_{ax,k}}{\gamma_{M,fi}} \approx 0.65 \times 1.05 \times \frac{14.67}{1} \approx 10.01 \text{ kN}$$

# Corrosion

## Understanding the Corrosion Issue

Many environments and materials can cause corrosion, including ocean salt air, fire retardants, fumes, fertilizers, preservative-treated wood, de-icing salts, dissimilar metals and more. Metal connectors, fasteners and anchors could corrode and lose load-carrying capacity when installed in corrosive environments or when installed in contact with corrosive materials.

When corrosion is caused by airborne solutions (ocean air, swimming halls, spray from a salt-treated street in winter, etc.) the metal parts can be in environments that are directly exposed to rain. They can be covered by a roof or inside the ventilated area of a facade.

The many variables present in a building environment make it impossible to accurately predict if, or when, corrosion will begin or reach a critical level. This relative uncertainty makes it crucial that specifiers and users are knowledgeable of the potential risks and

select a product suitable for the intended use. It is also prudent that regular maintenance and periodic inspections are performed, especially for outdoor applications.

It is common to see some corrosion in outdoor applications. Even stainless steel can corrode. The presence of some kinds of corrosion, e.g. white rust on zinc, does not mean that load capacity has been affected or that failure is imminent. If significant corrosion, e.g. red rust, is apparent or suspected, then a qualified engineer or inspector should inspect the framing members, fasteners and connectors. Replacement or cleansing of affected components may be appropriate. Red rust corrosion of steels will mostly carry on increasing and will cause major damage at an advanced stage.

## Galvanic Corrosion

Galvanic corrosion (also known as bimetallic corrosion, dissimilar metal corrosion or contact corrosion) may occur when dissimilar metals (e.g. galvanised mild steel and stainless steel) are in contact in a corrosive electrolyte (e.g. water containing salt, acid, etc.). When a galvanic couple forms, one of the metals in the couple becomes the anode and corrodes faster than it would all by itself, while the other becomes the cathode and corrodes slower than it would alone. For galvanic corrosion to occur, three conditions must be present:

1. Electrochemically dissimilar metals must be present,
2. These metals must be in electrical contact,
3. The metals must be exposed to an electrolyte.

The relative nobility of a material can be predicted by measuring its corrosion potential. The well-known galvanic series, (see below) lists the relative nobility of certain materials in seawater. A small anode/cathode area ratio is highly undesirable. In this case, the galvanic current is concentrated onto a small anodic area. Rapid thickness loss of the dissolving anode tends to occur under these conditions. Adverse area ratios are likely to occur with fasteners at joints.

### Galvanic Series of Metals

Corroded end (Anode)
Magnesium, Magnesium alloys and Zinc
Aluminium, Cadmium, Iron and Steel
Lead, Tin, Nickel and Ni-Cr alloy
Brasses, Copper and Cu-Ni alloys
Nickel
Stainless Steels
Protected end (Cathode)

Carbon steel fasteners used with stainless steel connectors should be avoided because the ratio of the area between the stainless steel to carbon steel is small and the fasteners will be subject to aggressive

attack, thus greater corrosion. Conversely, the rate of attack of a carbon steel connector secured by a stainless steel fastener is much slower. Prevention of bimetallic corrosion is possible by excluding an electrolyte from the connection by painting or taping over the joint. Alternatively, the two metals should be isolated from each other by painting each contact surface or using a non-metallic isolation material, typically nylon, neoprene or Teflon washers, pads, gaskets or bushes depending upon the particular application.

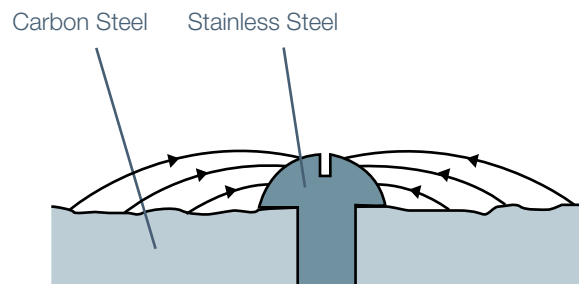

Large ANODE (Carbon Steel) area, small CATHODE (stainless steel fastener) area showing no attack on the fasteners and relatively insignificant attack of carbon steel.

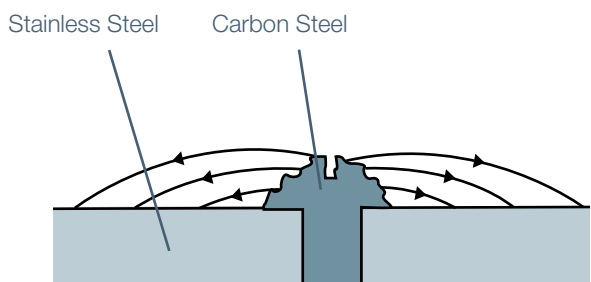

Large Cathode (Stainless Steel) area, small ANODE (carbon steel fastener) area showing no attack on the stainless steel and relatively increased attack of the fastener.

# Corrosion

## Materials and Coatings - Solid-Drive Structural Fasteners

### Electro Galvanised

C1 acc. to EN ISO 12944-2  
SC2 - 50 years acc. to EC5

The coating system consists of an electro plated zinc base layer. Depending on the thickness of the zinc layer, it can provide corrosion resistance that is adequate for service class 1 or 2.

### Yellow Zinc Plated

C2 acc. to EN ISO 12944-2  
SC2 - 50 years acc. to EC5

The coating system consists of an yellow plated zinc base layer. Depending on the thickness of the zinc layer, it can provide corrosion resistance that is adequate for service class 1 or 2.

### Electrocoat

C2 acc. to EN ISO 12944-2  
SC2 - 50 years acc. to EC5

Electrocoat utilizes electrical current to deposit the coating material onto the fastener. After application, the coating is oven cured. Electrocoat is intended for dry, indoor applications.

### Protec® +

C3 acc. to EN ISO 12944-2  
SC2 - 50 years acc. to EC5

Products are dipped in liquids that consists of zinc and aluminium flakes which is hardened in ovens after the spinning process. Finally a layer of wax is applied. Intended for outdoor applications.

### Double Barrier

C3 acc. to EN ISO 12944-2  
SC3 - 50 years acc. to EC5

The Simpson Strong-Tie® Double Barrier coating is a proprietary coating that provides a level of corrosion resistance that is equivalent to hot-dip galvanization and is intended for outdoor applications.

### Hot-Dip Galvanised

C4 acc. to EN ISO 12944-2  
SC3 - 50 years acc. to EC5

Hot dip galvanised nails are dipped in melted zinc 550-560°C, initiating a chemical reaction between the steel and the zinc. It provides a good corrosion resistance and is intended for outdoor applications.

### Impreg® +

C4 - 15 years acc. to EN ISO 12944-2  
SC2 - 50 years acc. to EC5

Products are dipped in liquids that consists of zinc and nickel. It provides a good corrosion performance for outdoor applications and has a low risk of galvanic corrosion together with Aluminum or Stainless Steel.

### Stainless Steel

C5 acc. to EN ISO 12944-2  
SC3 - 50 years acc. to EC5

Type 316 stainless steel is a nickel-chromium austenitic grade with 2-3% molybdenum. Type 316 stainless steel is not hardened by heat treatment and is inherently non-magnetic. It provides a level of corrosion protection suitable for marine and severe environments.

## Impreg® +

Impreg+ is an electrolytic, inorganic, surface treatment consisting of zinc and nickel. Due to the strong alloy combination the coating is very robust and suitable for corrosive environments.



- **C4 approved for 15 years according to EN ISO 11997-1:2017, cycle B**
- Compliant with REACH, RoHS- and ELV-directive
- Chromium (VI) free
- No galvanic corrosion in aluminium connections
- Due to the strong adhesion between the steel and the coating, Impreg+ will maintain the corrosion resistance even after installation
- Withstands temperatures up to 300° (C)

Comparison test EN ISO 11997-1:2017, Cycle B, 1240 hours, low (electro galvanised), medium (Impreg+), severe (stainless steel A4).



# Solid Wood Fastener Dimensioning Software



Welcome to the new Solid Wood

**Calculation according to our recently released ETA-21/0670**

**Support for CLT calculations according to ETA-21/0670**

**Increased number of strength classes for glulam**

**Link to our website to easily get more information about the products**

**Link to our DoP so you easily get access to the characteristic performance of the fasteners**

**New product recommendation indicator based on application, environment and chosen material**

**New space & Edge distance illustrations**

**Improved recommendation for how many fasteners to use based on given loads**

**Extended test report with part calculations**

If you have any questions or need further support just reach out to our technical support.

Solid-Drive™ SDWS Timber Screw

**Less Torque.  
More Strength.**







# Fastener Types with Characteristic Parameters



TTUFS/TTZNFS/TTSFS Countersunk WOOD Screw . . . . .	40
SWW/SWWZ Washer-Head WOOD Screw . . . . .	44
SWC Countersunk WOOD Screw . . . . .	48
SWD Double-Threaded WOOD Screw . . . . .	50
SSH Hex-Head CONNECTOR Screw . . . . .	52
SSF Flat Round-Head CONNECTOR Screw . . . . .	54
ESCRFTC Full-Threaded Countersunk WOOD Screw . . . . .	56
ESCRFTZ Full-Threaded Cylinder-Head WOOD Screw . . . . .	58
ESCRFT Full-Threaded Cylinder-Head WOOD Screw . . . . .	60
ESCR2R Double-Threaded Cylinder Head WOOD Screw . . . . .	62
CSA/CSA-Z/GSA-S CONNECTOR Screw . . . . .	64
CNA/CNA-G/CNA-S CONNECTOR Nail . . . . .	66
WSV Quik Drive® Collated WOOD Screw . . . . .	68
SDW/SDWS Structural WOOD Screw . . . . .	70

# Structural Fastening

Fastener Types

## Solid-Drive™ TTUFS/TTZNFS/TTSFS Countersunk WOOD Screw

*Structural Timber to Timber Connections Including Glulam, CLT and General Timber Applications*

The Solid-Drive® TTUFS, TTZNFS and TTSFS countersunk wood screws are available in a variety of dimensions and are designed for general timber to timber applications as well as for cross-laminated timber (CLT) and glulam construction.

TTUFS screws are electro galvanized for standard interior and dry applications only. TTZNFS screws are Impreg+ coated for increased corrosion protection and TTSFS screws are made in A4 stainless-steel material and can therefore be used in applications where premium corrosion protection is required.

**Codes/Standards:** ETA-21/0670

**For more information,** see pages 74, 76, 78, 119, 121, 223, 244, 246, 283, 295, 258, 260, 262.



TTUFS Screws in a wall-plate to CLT application.



TTUFS screws in light wall framing.

### Features

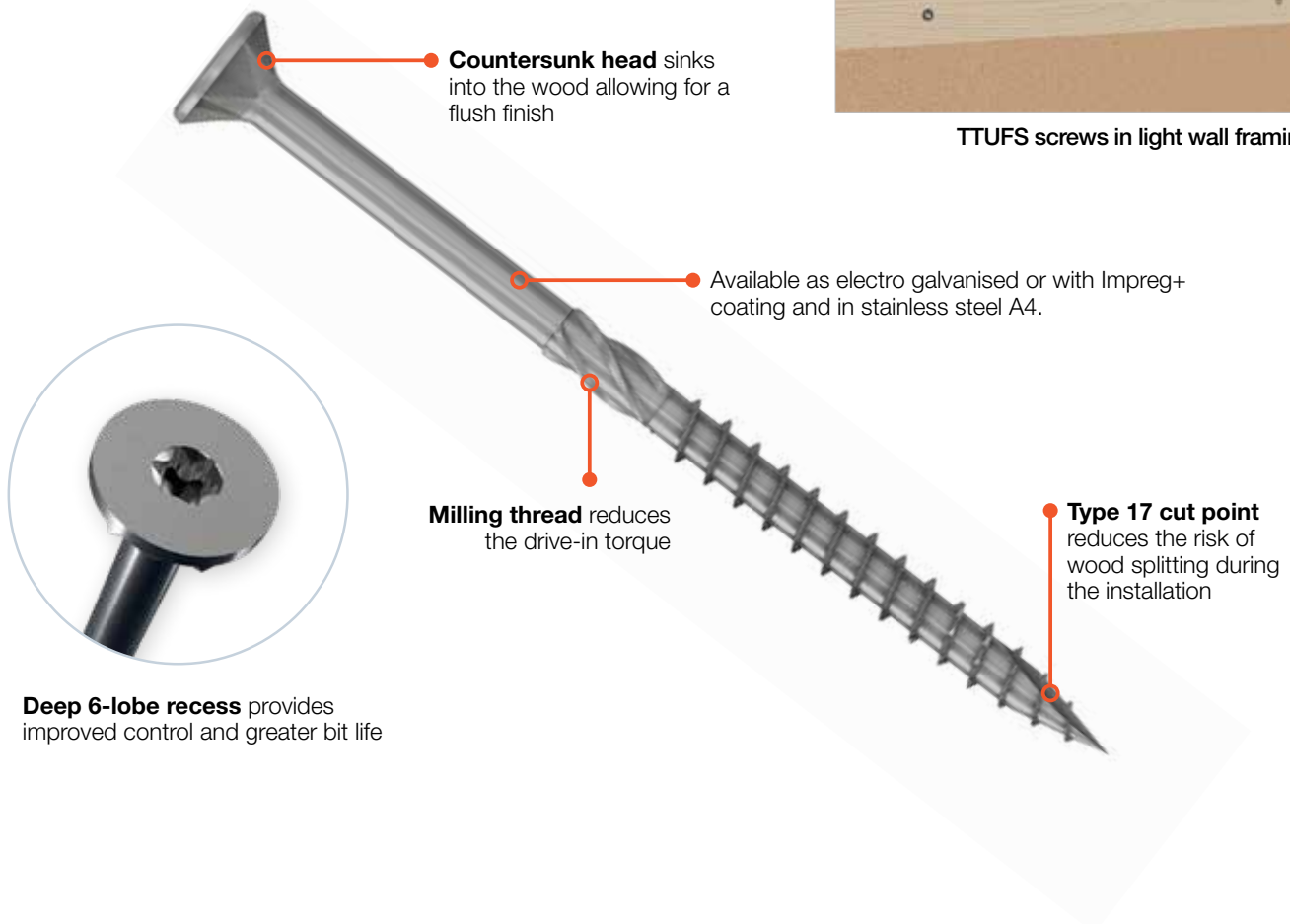

# Structural Fastening

## Solid-Drive™ TTUFS Countersunk WOOD Screw

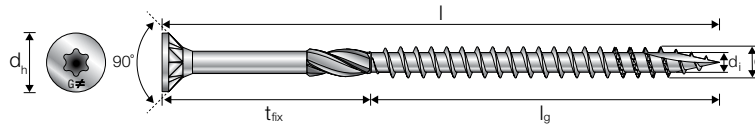
**Electro Galvanised**

 C1 acc. to EN ISO 12944-2  
 SC2 - 50 years acc. to EC5

### TTUFS – Range Overview

Reference	Article code	Dimensions [mm]					
		d	l	l <sub>g</sub>	d <sub>h</sub>	d <sub>1</sub>	t <sub>fix</sub>
TTUFS4.5X25	74434	4,5	25	20	8,4	2,8	5
TTUFS4.5X30	74435	4,5	30	25	8,4	2,8	5
TTUFS4.5X35	74436	4,5	35	30	8,4	2,8	5
TTUFS4.5X40	74437	4,5	40	35	8,4	2,8	5
TTUFS4.5X45	74438	4,5	45	29	8,4	2,8	16
TTUFS4.5X50	74439	4,5	50	30	8,4	2,8	20
TTUFS4.5X60	74440	4,5	60	35	8,4	2,8	25
TTUFS4.5X70	74441	4,5	70	40	8,4	2,8	30
TTUFS4.5X80	74442	4,5	80	50	8,4	2,8	30
TTUFS5.0X30	74373	5,0	30	25	9,5	3,1	5
TTUFS5.0X40	74374	5,0	40	35	9,5	3,1	5
TTUFS5.0X50	74375	5,0	50	30	9,5	3,1	20
TTUFS5.0X60	74376	5,0	60	35	9,5	3,1	25
TTUFS5.0X70	74377	5,0	70	40	9,5	3,1	30
TTUFS5.0X80	74378	5,0	80	40	9,5	3,1	40
TTUFS5.0X90	74379	5,0	90	45	9,5	3,1	45
TTUFS5.0X100	74443	5,0	100	60	9,5	3,1	40
TTUFS5.0X120	74372	5,0	120	60	9,5	3,1	60
TTUFS6.0X40	74455	6,0	40	34	11,6	3,7	6
TTUFS6.0X50	74457	6,0	50	30	11,6	3,7	20
TTUFS6.0X60	74458	6,0	60	35	11,6	3,7	25
TTUFS6.0X70	74459	6,0	70	40	11,6	3,7	30
TTUFS6.0X80	74460	6,0	80	40	11,6	3,7	40
TTUFS6.0X90	74461	6,0	90	45	11,6	3,7	45
TTUFS6.0X100	74380	6,0	100	60	11,6	3,7	40
TTUFS6.0X120	74451	6,0	120	70	11,6	3,7	50
TTUFS6.0X140	74452	6,0	140	70	11,6	3,7	70
TTUFS6.0X160	74453	6,0	160	70	11,6	3,7	90
TTUFS6.0X180	74454	6,0	180	70	11,6	3,7	110

### TTUFS – Characteristic Parameters

Reference	Characteristic Parameters				
	M <sub>y,k</sub> [Nmm]	f <sub>ax,k</sub> [N/mm <sup>2</sup> ]	f <sub>tens,k</sub> [kN]	f <sub>tor,k</sub> [Nm]	f <sub>head,k</sub> [N/mm <sup>2</sup> ]
TTUFS4.5	4660	14,7	7,8	4,7	15,6
TTUFS5.0	6720	15,0	7,9	6,0	17,1
TTUFS6.0	9500	12,5	11,1	9,4	16,6



Use Solid Wood to make your calculations.

 Go to [solidwood.strongtie.eu](http://solidwood.strongtie.eu)
 $f_{ax,k}$  is the characteristic withdrawal parameter for timber with a characteristic density of 350 kg/m<sup>3</sup>
 $f_{head,k}$  is the characteristic head pull through parameter for timber with a characteristic density of 350 kg/m<sup>3</sup> at max. 15 mm embedment.

 Ratio of the characteristic torsional strength to the mean insertion moment:  $f_{tor,k} / R_{tor,mean} \geq 1,5$

# Structural Fastening

## Solid-Drive™ TTZNFS Countersunk WOOD Screw, Impreg®+

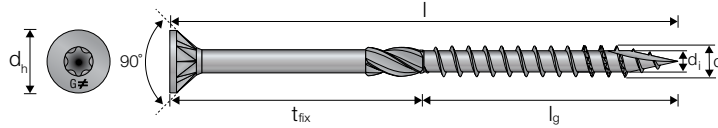

**Impreg®+**  
C4 – 15 years acc. to EN  
ISO 12944-2  
SC2 – 50 years acc. to EC5

### TTZNFS – Range Overview

Reference	Article code	Dimensions [mm]					
		d	l	l <sub>g</sub>	d <sub>h</sub>	d <sub>i</sub>	t <sub>fix</sub>
TTZNFS4.5X25	74481	4,5	25	20	8,4	2,8	5
TTZNFS4.5X30	74482	4,5	30	25	8,4	2,8	5
TTZNFS4.5X35	76582	4,5	35	30	8,4	2,8	5
TTZNFS4.5X40	74483	4,5	40	35	8,4	2,8	5
TTZNFS4.5X45	76561	4,5	45	29	8,4	2,8	16
TTZNFS4.5X50	74484	4,5	50	30	8,4	2,8	20
TTZNFS4.5X60	74485	4,5	60	35	8,4	2,8	25
TTZNFS4.5X70	74486	4,5	70	40	8,4	2,8	30
TTZNFS4.5X80	76563	4,5	80	50	8,4	2,8	30
TTZNFS5.0X30	76535	5,0	30	25	9,5	3,1	5
TTZNFS5.0X40	76536	5,0	40	35	9,5	3,1	5
TTZNFS 5.0X50	74489	5,0	50	30	9,5	3,1	20
TTZNFS 5.0X60	74490	5,0	60	35	9,5	3,1	25
TTZNFS5.0X70	74491	5,0	70	40	9,5	3,1	30
TTZNFS5.0X80	74493	5,0	80	40	9,5	3,1	40
TTZNFS5.0X90	74495	5,0	90	45	9,5	3,1	45
TTZNFS5.0X100	74487	5,0	100	60	9,5	3,1	40
TTZNFS5.0X120	74488	5,0	120	60	9,5	3,1	60
TTZNFS6.0X40	76566	6,0	40	34	11,6	3,7	6
TTZNFS6.0X50	76567	6,0	50	30	11,6	3,7	20
TTZNFS6.0X60	74504	6,0	60	35	11,6	3,7	25
TTZNFS6.0X70	74505	6,0	70	40	11,6	3,7	30
TTZNFS6.0X80	74506	6,0	80	40	11,6	3,7	40
TTZNFS6.0X90	74508	6,0	90	45	11,6	3,7	45
TTZNFS6.0X100	74497	6,0	100	60	11,6	3,7	40
TTZNFS6.0X120	74499	6,0	120	70	11,6	3,7	50
TTZNFS6.0X140	74501	6,0	140	70	11,6	3,7	70
TTZNFS6.0X160	74502	6,0	160	70	11,6	3,7	90
TTZNFS6.0X180	74503	6,0	180	70	11,6	3,7	110

### TTZNFS – Characteristic Parameters

Reference	Characteristic Parameters				
	M <sub>y,k</sub> [Nmm]	f <sub>ax,k</sub> [N/mm²]	f <sub>tens,k</sub> [kN]	f <sub>tor,k</sub> [Nm]	f <sub>head,k</sub> [N/mm²]
TTZNFS4,5	4660	14,7	7,8	4,7	15,6
TTZNFS5,0	6720	15,0	7,9	6,0	17,1
TTZNFS6,0	9500	12,5	11,1	9,4	16,6



Use Solid Wood to make your calculations.  
Go to [solidwood.strongtie.eu](http://solidwood.strongtie.eu)

f<sub>ax,k</sub> is the characteristic withdrawal parameter for timber with a characteristic density of 350 kg/m³

f<sub>head,k</sub> is the characteristic head pull through parameter for timber with a characteristic density of 350 kg/m³ at max. 15 mm embedment.

Ratio of the characteristic torsional strength to the mean insertion moment: f<sub>tor,k</sub> / R<sub>tor,mean</sub> ≥ 1,5



# Structural Fastening

## Solid-Drive™

### TTSFS Countersunk WOOD Screw, Stainless Steel A4

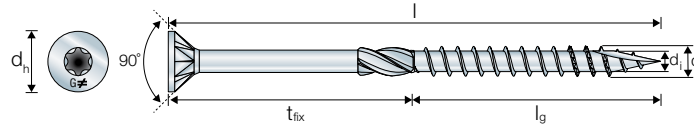

Stainless Steel  
C5 acc. to EN ISO 12944-2  
SC3 - 50 years acc. to EC5



#### TTSFS – Range Overview

Reference	Article code	Dimensions [mm]					
		d	l	l <sub>g</sub>	d <sub>h</sub>	d <sub>i</sub>	t <sub>fix</sub>
TTSFS5.0X60	74446	5,0	60	32	9,5	3,1	28
TTSFS5.0X70	74447	5,0	70	35	9,5	3,1	35
TTSFS5.0X80	74448	5,0	80	40	9,5	3,1	40
TTSFS5.0X90	74449	5,0	90	45	9,5	3,1	45
TTSFS5.0X100	74444	5,0	100	55	9,5	3,1	45
TTSFS5.0X120	74445	5,0	120	60	9,5	3,1	60
TTSFS6.0X70	74473	6,0	70	35	11,6	3,7	35
TTSFS6.0X80	74474	6,0	80	40	11,6	3,7	40
TTSFS6.0X90	74475	6,0	90	45	11,6	3,7	45
TTSFS6.0X100	74450	6,0	100	55	11,6	3,7	45
TTSFS6.0X120	74471	6,0	120	60	11,6	3,7	60
TTSFS6.0X140	74472	6,0	140	65	11,6	3,7	75

#### TTSFS – Characteristic Parameters

Reference	Characteristic Parameters				
	M <sub>y,k</sub> [Nmm]	f <sub>ax,k</sub> [N/mm <sup>2</sup> ]	f <sub>tens,k</sub> [kN]	f <sub>tor,k</sub> [Nm]	f <sub>head,k</sub> [N/mm <sup>2</sup> ]
TTSFS5.0	4710	14,9	6,3	4,9	16,0
TTSFS6.0	8570	13,6	9,5	8,8	16,2



Use Solid Wood to make your calculations.

Go to [solidwood.strongtie.eu](http://solidwood.strongtie.eu)

f<sub>ax,k</sub> is the characteristic withdrawal parameter for timber with a characteristic density of 350 kg/m<sup>3</sup>

f<sub>head,k</sub> is the characteristic head pull through parameter for timber with a characteristic density of 350 kg/m<sup>3</sup> at max. 15 mm embedment.

Ratio of the characteristic torsional strength to the mean insertion moment: f<sub>tor,k</sub> / R<sub>tor,mean</sub> ≥ 1,5

# Structural Fastening

Fastener Types

## Solid-Drive™ SWW/SWWZ Washer-Head WOOD Screw

*Structural Timber to Timber Connections Including Glulam, CLT and General Timber Applications*

SWW/SWWZ are washer-head structural screws designed for load-bearing wood structures. The SWW/SWWZ screws have a milling thread to allow for smooth driving of the shank. The large washer head gives high head pull-through resistance while allowing the wood members to close up firmly.

These partially-threaded, 6.0, 8.0 and 10.0 mm diameter structural fasteners are designed to pull structural members together with superb holding power and excellent load capacity. The large washer head provides extreme pull-through resistance while allowing the wood members to close up firmly. Predrilling is not typically required. SWW screws are yellow zinc plated for standard interior and dry applications only. SWWZ screws are Impreg+ coated for increased corrosion protection

**Codes/Standards:** ETA-21/0670

**For more information,** see pages 81, 86, 126, 131, 184, 196, 206.



SWW screws in a 90° T-connection between two CLT walls.



ETA-21/0670



SWW screw installed in a sound insulated CLT floor application.

### Features

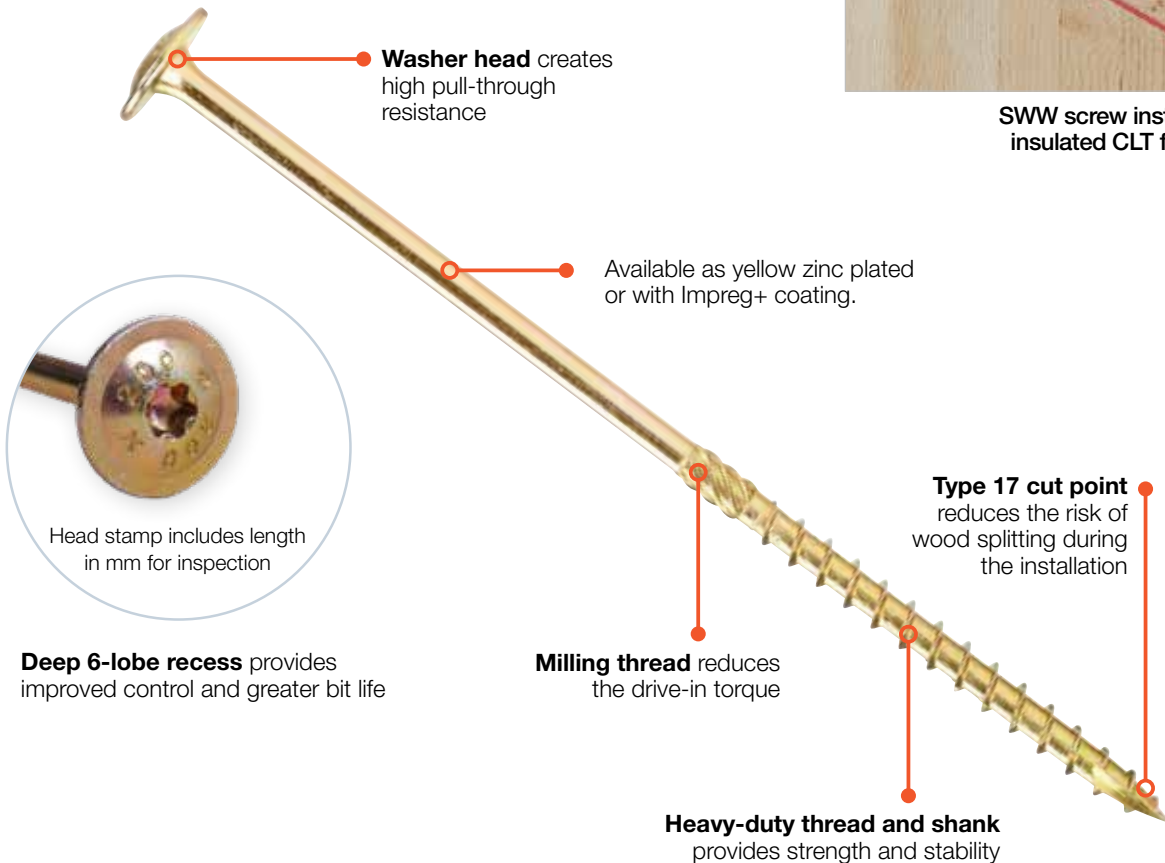

# Structural Fastening

## Solid-Drive™ SWW Washer-Head WOOD Screw

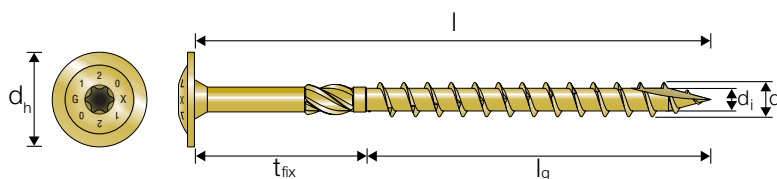
**Yellow Zinc Plated**

 C2 acc. to EN ISO 12944-2  
 SC2 – 50 years acc. to EC5

### SWW – Range Overview

Reference	Article code	Dimensions [mm]					
		d	l	l <sub>g</sub>	d <sub>h</sub>	d <sub>i</sub>	t <sub>fix</sub>
SWW6.0X60	75382	6.0	60	42	14	3,9	18
SWW6.0X80	75383	6.0	80	50	14	3,9	30
SWW6.0X100	75384	6.0	100	50	14	3,9	50
SWW6.0X120	75385	6.0	120	50	14	3,9	70
SWW6.0X140	75386	6.0	140	70	14	3,9	70
SWW6.0X160	75387	6.0	160	70	14	3,9	90
SWW6.0X180	75388	6.0	180	70	14	3,9	110
SWW6.0X200	75389	6.0	200	70	14	3,9	130
SWW6.0X220	75390	6.0	220	70	14	3,9	150
SWW6.0X240	75391	6.0	240	70	14	3,9	170
SWW6.0X260	75392	6.0	260	70	14	3,9	190
SWW6.0X280	75393	6.0	280	70	14	3,9	210
SWW6.0X300	75394	6.0	300	70	14	3,9	230
SWW8.0X80	75395	8.0	80	50	22	5,2	30
SWW8.0X100	75396	8.0	100	50	22	5,2	50
SWW8.0X120	75397	8.0	120	80	22	5,2	40
SWW8.0X140	75398	8.0	140	80	22	5,2	60
SWW8.0X160	75399	8.0	160	80	22	5,2	80
SWW8.0X180	75400	8.0	180	80	22	5,2	100
SWW8.0X200	75401	8.0	200	80	22	5,2	120
SWW8.0X220	75402	8.0	220	80	22	5,2	140
SWW8.0X240	75403	8.0	240	80	22	5,2	160
SWW8.0X260	75404	8.0	260	80	22	5,2	180
SWW8.0X280	75405	8.0	280	80	22	5,2	200
SWW8.0X300	75406	8.0	300	80	22	5,2	220
SWW8.0X320	75407	8.0	320	80	22	5,2	240
SWW8.0X340	75408	8.0	340	80	22	5,2	260
SWW8.0X360	75409	8.0	360	80	22	5,2	280
SWW8.0X380	75410	8.0	380	80	22	5,2	300
SWW8.0X400	75411	8.0	400	80	22	5,2	320

Table continues on next page.

### SWW – Characteristic Parameters

Reference	Characteristic Parameters				
	M <sub>y,k</sub> [Nmm]	f <sub>ax,k</sub> [N/mm <sup>2</sup> ]	f <sub>tens,k</sub> [kN]	f <sub>tor,k</sub> [Nm]	f <sub>head,k</sub> [N/mm <sup>2</sup> ]
SWW6.0	10500	13,0	12,3	11,0	16,1
SWW8.0	25900	12,6	23,7	27,4	10,5
SWW10.0	43700	12,2	33,8	48,9	10,2

 $f_{ax,k}$  is the characteristic withdrawal parameter for timber with a characteristic density of 350 kg/m<sup>3</sup>
 $f_{head,k}$  is the characteristic head pull through parameter for timber with a characteristic density of 350 kg/m<sup>3</sup> at max. 15 mm embedment.

 Ratio of the characteristic torsional strength to the mean insertion moment:  $f_{tor,k} / R_{tor,mean} \geq 1,5$ 

Use Solid Wood to make your calculations.

 Go to [solidwood.strongtie.eu](http://solidwood.strongtie.eu)

# Structural Fastening

## SWW – Range Overview (continued)

Reference	Article code	Dimensions [mm]					
		d	l	l <sub>g</sub>	d <sub>n</sub>	d <sub>i</sub>	t <sub>tox</sub>
SWW10.0X100	76912	10.0	100	50	25	6,2	50
SWW10.0X120	76913	10.0	120	50	25	6,2	70
SWW10.0X140	76914	10.0	140	80	25	6,2	60
SWW10.0X160	75412	10.0	160	80	25	6,2	80
SWW10.0X180	75413	10.0	180	80	25	6,2	100
SWW10.0X200	75414	10.0	200	80	25	6,2	120
SWW10.0X220	75415	10.0	220	80	25	6,2	140
SWW10.0X240	75416	10.0	240	80	25	6,2	160
SWW10.0X260	75417	10.0	260	80	25	6,2	180
SWW10.0X280	75418	10.0	280	80	25	6,2	200
SWW10.0X300	75419	10.0	300	80	25	6,2	220
SWW10.0X320	75420	10.0	320	80	25	6,2	240
SWW10.0X340	75421	10.0	340	80	25	6,2	260
SWW10.0X360	75422	10.0	360	80	25	6,2	280
SWW10.0X380	75423	10.0	380	80	25	6,2	300
SWW10.0X400	75424	10.0	400	80	25	6,2	320

## SWW – Characteristic Parameters

Reference	Characteristic Parameters				
	M <sub>y,k</sub> [Nmm]	f <sub>ax,k</sub> [N/mm <sup>2</sup> ]	f <sub>tens,k</sub> [kN]	f <sub>tor,k</sub> [Nm]	f <sub>head,k</sub> [N/mm <sup>2</sup> ]
SWW6.0	10500	13,0	12,3	11,0	16,1
SWW8.0	25900	12,6	23,7	27,4	10,5
SWW10.0	43700	12,2	33,8	48,9	10,2



Use Solid Wood to make your calculations.

Go to [solidwood.strongtie.eu](https://solidwood.strongtie.eu)

f<sub>ax,k</sub> is the characteristic withdrawal parameter for timber with a characteristic density of 350 kg/m<sup>3</sup>

f<sub>head,k</sub> is the characteristic head pull through parameter for timber with a characteristic density of 350 kg/m<sup>3</sup> at max. 15 mm embedment.

Ratio of the characteristic torsional strength to the mean insertion moment: f<sub>tor,k</sub> / R<sub>tor,mean</sub> ≥ 1,5

# Structural Fastening

## Solid-Drive™ SWWZ Washer-Head WOOD Screw, Impreg®+

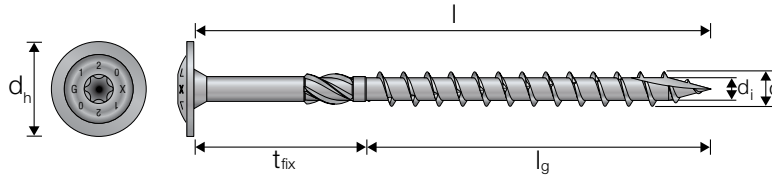

**Impreg®+**  
C4 – 15 years acc. to EN  
ISO 12944-2  
SC2 – 50 years acc. to EC5

### SWWZ – Range Overview

Reference	Article code	Dimensions [mm]					
		d	l	l <sub>g</sub>	d <sub>h</sub>	d <sub>i</sub>	t <sub>fix</sub>
SWWZ6.0X80	76352	6,0	80	50	14	3,9	30
SWWZ6.0X90	76452	6,0	90	50	14	3,9	40
SWWZ6.0X100	76453	6,0	100	50	14	3,9	50
SWWZ6.0X120	76454	6,0	120	50	14	3,9	70
SWWZ8.0X80	76455	8,0	80	50	22	5,2	30
SWWZ8.0X90	76457	8,0	90	50	22	5,2	40
SWWZ8.0X100	76601	8,0	100	50	22	5,2	50
SWWZ8.0X120	76603	8,0	120	80	22	5,2	40
SWWZ8.0X140	76604	8,0	140	80	22	5,2	60
SWWZ8.0X180	76605	8,0	180	80	22	5,2	100
SWWZ8.0X200	76606	8,0	200	80	22	5,2	120
SWWZ8.0X240	76607	8,0	240	80	22	5,2	160
SWWZ8.0X300	76608	8,0	300	80	22	5,2	220
SWWZ8.0X340	76609	8,0	340	80	22	5,2	260
SWWZ10.0X160	76610	10,0	160	80	25	6,2	80
SWWZ10.0X180	76611	10,0	180	80	25	6,2	100
SWWZ10.0X200	76612	10,0	200	80	25	6,2	120
SWWZ10.0X240	76613	10,0	240	80	25	6,2	160

### SWWZ – Characteristic Parameters

Reference	Characteristic Parameters				
	M <sub>y,k</sub> [Nmm]	f <sub>ax,k</sub> [N/mm <sup>2</sup> ]	f <sub>lens,k</sub> [kN]	f <sub>tor,k</sub> [Nm]	f <sub>head,k</sub> [N/mm <sup>2</sup> ]
SWWZ6.0	10500	13,0	12,3	11,0	16,1
SWWZ8.0	25900	12,6	23,7	27,4	10,5
SWWZ10.0	43700	12,2	33,8	48,9	10,2



Use Solid Wood to make your calculations.

Go to [solidwood.strongtie.eu](http://solidwood.strongtie.eu)

f<sub>ax,k</sub> is the characteristic withdrawal parameter for timber with a characteristic density of 350 kg/m<sup>3</sup>

f<sub>head,k</sub> is the characteristic head pull through parameter for timber with a characteristic density of 350 kg/m<sup>3</sup> at max. 15 mm embedment.

Ratio of the characteristic torsional strength to the mean insertion moment: f<sub>tor,k</sub> / R<sub>tor,mean</sub> ≥ 1,5

# Structural Fastening

Fastener Types

## Solid-Drive™ SWC Countersunk WOOD Screw

*Structural Timber to Timber Connections Including Glulam, CLT and General Interior Applications*

SWC is a countersunk structural screw designed for load-bearing wood structures. The SWC screw has a milling thread to allow for smooth driving of the shank. The countersunk head gives flush fitting while allowing the wood members to close up firmly.

These partially-threaded, 6.0, 8.0 and 10.0 mm diameter structural fasteners are designed to pull structural members together with superb holding power and excellent load capacity. The countersunk head and underhead nibs provide for clean countersinking, flush with the surface. Predrilling is not typically required. For interior and dry applications only.

**Codes/Standards:** ETA-21/0670

**For more information,** see pages 89, 134, 187, 198, 210, 248.

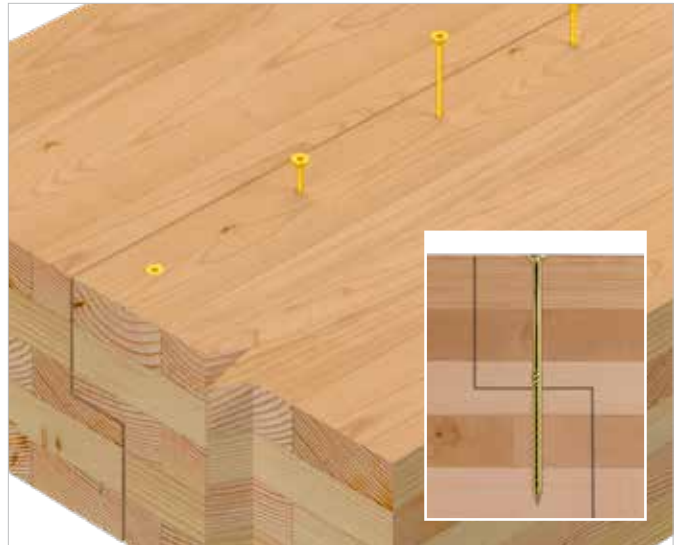

SWC screws installed in a CLT lap-joint application.



SWC screw installed in a CLT spline.



ETA-21/0670

### Features

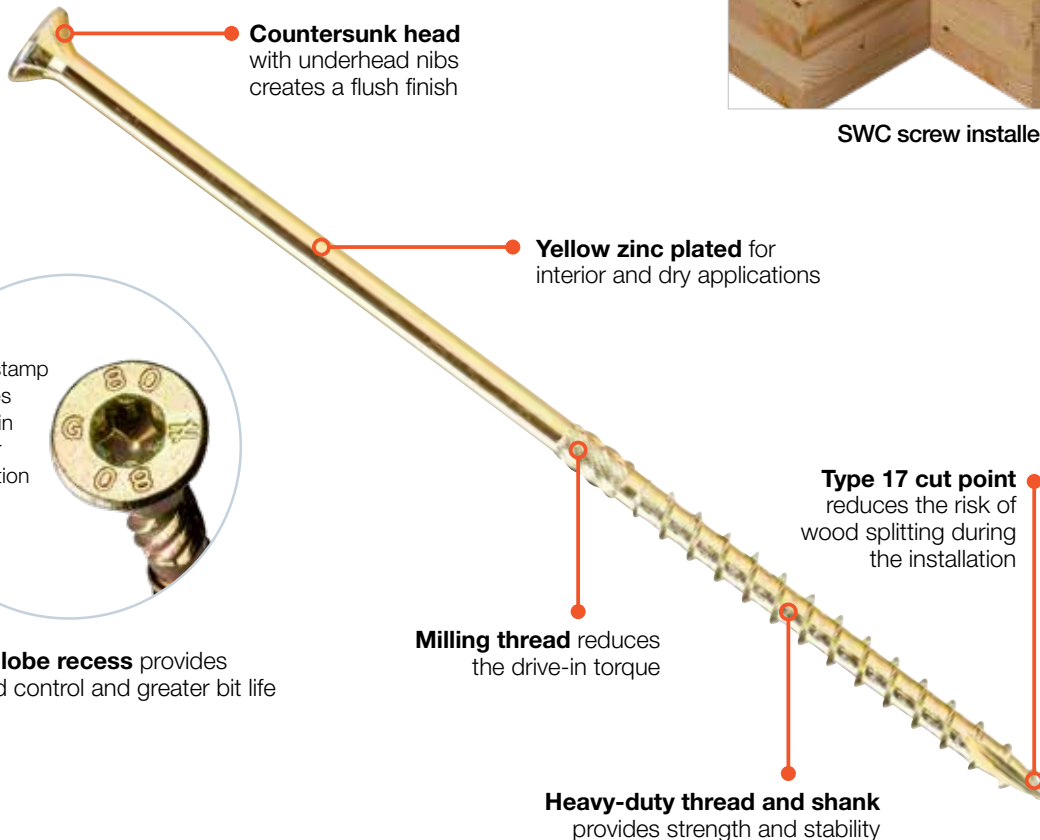

**Deep 6-lobe recess** provides improved control and greater bit life



# Structural Fastening

## Solid-Drive™ SWC Countersunk WOOD Screw

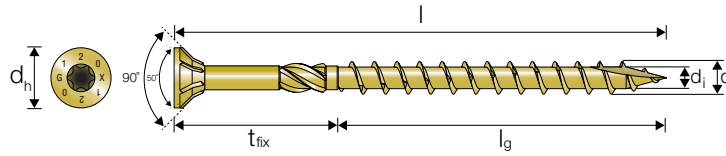
**Yellow Zinc Plated**

 C2 acc. to EN ISO 12944-2  
 SC2 – 50 years acc. to EC5

### SWC – Range Overview

Reference	Article code	Dimensions [mm]					
		d	l	l <sub>g</sub>	d <sub>h</sub>	d <sub>i</sub>	t <sub>fix</sub>
SWC6.0X200	75346	6,0	200	70	11,8	3,9	130
SWC6.0X220	75347	6,0	220	70	11,8	3,9	150
SWC6.0X240	75348	6,0	240	70	11,8	3,9	170
SWC6.0X260	75349	6,0	260	70	11,8	3,9	190
SWC6.0X280	75350	6,0	280	70	11,8	3,9	210
SWC6.0X300	75351	6,0	300	70	11,8	3,9	230
SWC8.0X80	75352	8,0	80	50	14,6	5,2	30
SWC8.0X100	75353	8,0	100	50	14,6	5,2	50
SWC8.0X120	75354	8,0	120	80	14,6	5,2	40
SWC8.0X140	75355	8,0	140	80	14,6	5,2	60
SWC8.0X160	75356	8,0	160	80	14,6	5,2	80
SWC8.0X180	75357	8,0	180	80	14,6	5,2	100
SWC8.0X200	75358	8,0	200	80	14,6	5,2	120
SWC8.0X220	75359	8,0	220	80	14,6	5,2	140
SWC8.0X240	75360	8,0	240	80	14,6	5,2	160
SWC8.0X260	75361	8,0	260	80	14,6	5,2	180
SWC8.0X280	75362	8,0	280	80	14,6	5,2	200
SWC8.0X300	75363	8,0	300	80	14,6	5,2	220
SWC8.0X320	75364	8,0	320	80	14,6	5,2	240
SWC8.0X340	75365	8,0	340	80	14,6	5,2	260
SWC8.0X360	75366	8,0	360	80	14,6	5,2	280
SWC8.0X380	75367	8,0	380	80	14,6	5,2	300
SWC8.0X400	75368	8,0	400	80	14,6	5,2	320
SWC10.0X100	76916	10,0	100	50	17,8	6,2	50
SWC10.0X120	76917	10,0	120	50	17,8	6,2	70
SWC10.0X140	76918	10,0	140	80	17,8	6,2	60
SWC10.0X160	75369	10,0	160	80	17,8	6,2	80
SWC10.0X180	75370	10,0	180	80	17,8	6,2	100
SWC10.0X200	75371	10,0	200	80	17,8	6,2	120
SWC10.0X220	75372	10,0	220	80	17,8	6,2	140
SWC10.0X240	75373	10,0	240	80	17,8	6,2	160
SWC10.0X260	75374	10,0	260	80	17,8	6,2	180
SWC10.0X280	75375	10,0	280	80	17,8	6,2	200
SWC10.0X300	75376	10,0	300	80	17,8	6,2	220
SWC10.0X320	75377	10,0	320	80	17,8	6,2	240
SWC10.0X340	75378	10,0	340	80	17,8	6,2	260
SWC10.0X360	75379	10,0	360	80	17,8	6,2	280
SWC10.0X380	75380	10,0	380	80	17,8	6,2	300
SWC10.0X400	75381	10,0	400	80	17,8	6,2	320

### SWC – Characteristic Parameters

Reference	Characteristic Parameters				
	M <sub>y,k</sub> [Nmm]	f <sub>ax,k</sub> [N/mm²]	f <sub>tens,k</sub> [kN]	f <sub>tor,k</sub> [Nm]	f <sub>head,k</sub> [N/mm²]
SWC6.0	10500	13,0	12,3	11,0	11,9
SWC8.0	25900	12,6	23,7	27,4	12,5
SWC10.0	43700	12,2	33,8	48,9	11,2



Use Solid Wood to make your calculations.

 Go to [solidwood.strongtie.eu](http://solidwood.strongtie.eu)

 f<sub>ax,k</sub> is the characteristic withdrawal parameter for timber with a characteristic density of 350 kg/m³

 f<sub>head,k</sub> is the characteristic head pull through parameter for timber with a characteristic density of 350 kg/m³ at max. 15 mm embedment.

 Ratio of the characteristic torsional strength to the mean insertion moment: f<sub>tor,k</sub> / R<sub>tor,mean</sub> ≥ 1,5

# Structural Fastening

Fastener Types

## Solid-Drive™ SWD Double-Threaded WOOD Screw

*Structural Timber to Timber Connections Including Glulam, CLT and General Interior Applications*

The Solid-Drive® SWD is a double threaded structural screw designed to connect and pull together two wood members.

The small cylinder-head reduces the insertion torque and makes it possible to countersink the screws. The Protec+ coating is a wear resistant coating that can endure the friction of the installation and the exposure of high loads from the structural applications.

SWD screws are suitable for inclined and angled installations. Use the GSCREW screw guide to ensure that screws are installed with the correct angle into the timber.

**Codes/Standards:** ETA-21/0670

**For more information,** see pages 94, 139, 160, 165, 191, 201, 213, 217, 220.



SWD screws in a CLT butt-joint application.



SWD inclined installation of CLT floor panels.



### Features

- Small cylinder head** sinks into the wood allowing for hidden assemblies
- Protec+ coating** for protected outdoor applications
- Deep 6-lobe recess** provides improved control and greater bit life
- The differentiated thread** pitch creates a clamping effect that pulls the wood members together
- The chisel point** allows for skewed installations



Use the **GSCREW** screw guide to install SWD in inclined and angled installations.

# Structural Fastening

## Solid-Drive™ SWD Double-Threaded WOOD Screw

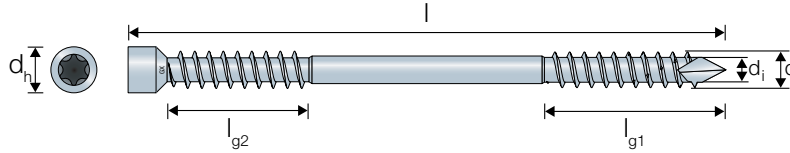

**Protec® +**  
C3 acc. to EN ISO 12944-2  
SC2 - 50 years acc. to EC5

### SWD – Range Overview

Reference	Article code	Dimensions [mm]					
		d	l	l <sub>g1</sub>	l <sub>g2</sub>	d <sub>h</sub>	d <sub>i</sub>
SWD6.5X65	75425	6,5	65	28	21,5	8	4
SWD6.5X90	75426	6,5	90	40	33,5	8	4
SWD6.5X130	75427	6,5	130	40	33,5	8	4
SWD6.5X160	75428	6,5	160	65	58,5	8	4
SWD6.5X190	75429	6,5	190	80	73,5	8	4
SWD6.5X220	75430	6,5	220	95	88,5	8	4
SWD8.0X90	75431	8,0	90	40	31,5	10	5,4
SWD8.0X130	75432	8,0	130	40	31,5	10	5,4
SWD8.0X160	75433	8,0	160	65	56,5	10	5,4
SWD8.0X190	75434	8,0	190	80	71,5	10	5,4
SWD8.0X220	75435	8,0	220	95	86,5	10	5,4
SWD8.0X245	75436	8,0	245	107	99	10	5,4
SWD8.0X275	75437	8,0	275	107	99	10	5,4
SWD8.0X300	75438	8,0	300	135	126,5	10	5,4
SWD8.0X330	75439	8,0	330	135	126,5	10	5,4

### SWD – Characteristic Parameters

Reference	Characteristic Parameters				
	M <sub>y,k</sub> [Nmm]	f <sub>ax,k</sub> [N/mm <sup>2</sup> ]	f <sub>tens,k</sub> [kN]	f <sub>tor,k</sub> [Nm]	f <sub>head,k</sub> [N/mm <sup>2</sup> ]
SWD6.5	12400	13,7	14,5	12,6	1000
SWD8.0	26800	13,1	25,3	27,7	1000



Use Solid Wood to make your calculations.

Go to [solidwood.strongtie.eu](http://solidwood.strongtie.eu)

f<sub>ax,k</sub> is the characteristic withdrawal parameter for timber with a characteristic density of 350 kg/m<sup>3</sup>

f<sub>head,k</sub> is the characteristic head pull through parameter for timber with a characteristic density of 350 kg/m<sup>3</sup> at max. 15 mm embedment.

Ratio of the characteristic torsional strength to the mean insertion moment: f<sub>tor,k</sub> / R<sub>tor,mean</sub> ≥ 1,5

# Structural Fastening

Fastener Types

## Solid-Drive™ SSH Hex-Head CONNECTOR Screw

*Simpson Strong-Tie® Connectors to Timber and General Steel to Timber Applications*

The Solid-Drive® SSH hex-head screw is a structural fastener designed for cross-laminated timber (CLT), glulam construction and general metal to wood applications.

These partially-threaded, sturdy 6.0, 8.0, 10.0 and 12.0 mm diameter structural fasteners are designed to provide excellent connection strength, especially when connecting steel plate or angle connectors to wood. The unique head combining hex and torx allows for the convenience of driving with either a hex-driver bit or 6-lobe driver bit. The SSH screws are Impreg+ coated for increased corrosion protection. They have a robust knurled shank and type-17 cut-point for fast starts and low-torque driving.

**Codes/Standards:** ETA-21/0670

**For more information,** see pages 97, 142, 230.



SSH screws fastening of AB25SSH angle bracket.



### Features

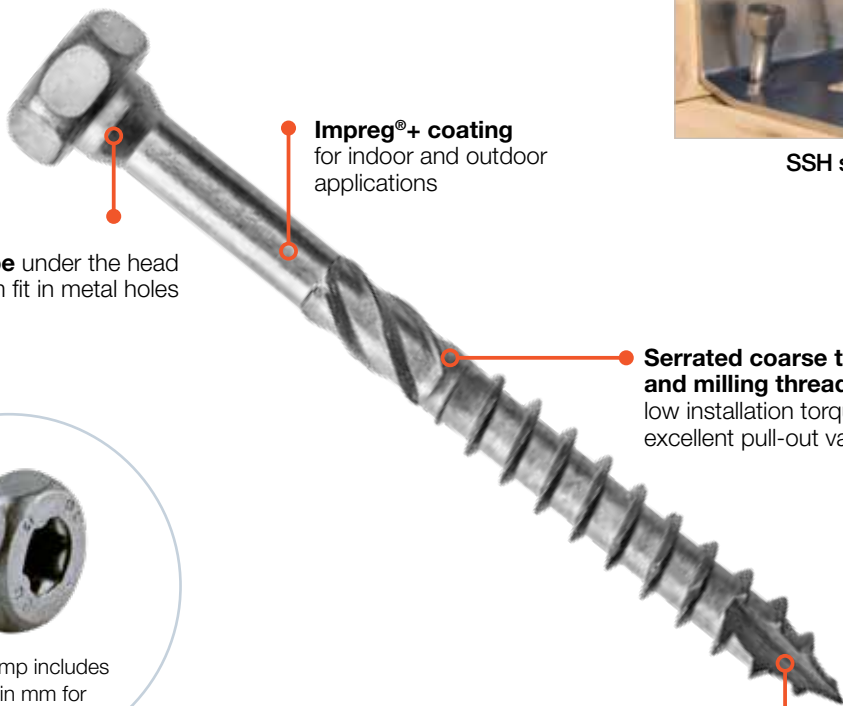

**Impreg®+ coating** for indoor and outdoor applications

**Conical shape** under the head for maximum fit in metal holes

**Serrated coarse thread and milling thread** for low installation torque and excellent pull-out values

**Type 17 cut point** reduces the risk of wood splitting during the installation



Head stamp includes length in mm for inspection

**Hex-head with 6-lobe recess** allows for the convenience of driving with either a hex-driver bit or 6-lobe driver bit



6.0 mm SSH screws have a slightly different head design



SSH screws fastening of AB25SSH heavy-duty angle bracket.

# Structural Fastening

## Solid-Drive™ SSH Hex-Head CONNECTOR Screw

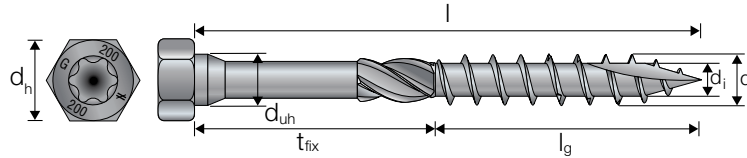

**Impreg®+**  
C4 – 15 years acc. to EN  
ISO 12944-2  
SC2 – 50 years acc. to EC5

### SSH – Range Overview

Reference	Article code	Dimensions [mm]					
		d/d <sub>uh</sub>	l	l <sub>g</sub>	d <sub>h</sub>	d <sub>i</sub>	t <sub>fix</sub>
SSH6.0X40*	75128	6,0	40	24	14,5 (10)	3,65	16
SSH6.0X50*	75129	6,0	50	33	14,5 (10)	3,65	17
SSH6.0X60*	75130	6,0	60	42	14,5 (10)	3,65	18
SSH6.0X75*	75131	6,0	75	42	14,5 (10)	3,65	33
SSH6.0X90*	75132	6,0	90	42	14,5 (10)	3,65	48
SSH6.0X120*	75133	6,0	120	75	14,5 (10)	3,65	45
SSH8.0X40	75134	8,0	40	32	13	5,1	8
SSH8.0X50	75135	8,0	50	42	13	5,1	8
SSH8.0X60	75136	8,0	60	42	13	5,1	18
SSH8.0X80	75137	8,0	70	42	13	5,1	38
SSH8.0X90	75138	8,0	80	42	13	5,1	35
SSH8.0X100	75139	8,0	90	55	13	5,1	15
SSH8.0X120	75140	8,0	100	85	13	5,1	35
SSH8.0X140	75141	8,0	120	85	13	5,1	30
SSH8.0X160	75142	8,0	140	110	13	5,1	50
SSH8.0X180	75143	8,0	160	110	13	5,1	70
SSH8.0X200	75144	8,0	180	110	13	5,1	90
SSH8.0X240	75145	8,0	200	110	13	5,1	130
SSH8.0X260	75146	8,0	240	110	13	5,1	150
SSH8.0X280	75147	8,0	260	110	13	5,1	170
SSH8.0X300	75148	8,0	280	110	13	5,1	190
SSH10.0X50	75150	10,0	50	42	15	6,15	8
SSH10.0X60	75151	10,0	60	42	15	6,15	18
SSH10.0X80	75152	10,0	80	42	15	6,15	38
SSH10.0X90	75153	10,0	90	42	15	6,15	48
SSH10.0X100	75154	10,0	100	55	15	6,15	45
SSH10.0X120	75155	10,0	120	85	15	6,15	35
SSH10.0X140	75156	10,0	140	85	15	6,15	55
SSH10.0X160	75157	10,0	160	110	15	6,15	50
SSH10.0X180	75158	10,0	180	110	15	6,15	70
SSH10.0X200	75159	10,0	200	110	15	6,15	90
SSH10.0X240	75160	10,0	240	125	15	6,15	115
SSH10.0X280	75161	10,0	280	125	15	6,15	155

Reference	Article code	Dimensions [mm]					
		d/d <sub>uh</sub>	l	l <sub>g</sub>	d <sub>h</sub>	d <sub>i</sub>	t <sub>fix</sub>
SSH12.0X60	75162	12,0	60	48	17	6,7	12
SSH12.0X80	75163	12,0	80	48	17	6,7	32
SSH12.0X90	75164	12,0	90	48	17	6,7	42
SSH12.0X100	75165	12,0	100	55	17	6,7	45
SSH12.0X120	75166	12,0	120	85	17	6,7	35
SSH12.0X140	75167	12,0	140	85	17	6,7	55
SSH12.0X160	75168	12,0	160	110	17	6,7	50
SSH12.0X180	75169	12,0	180	110	17	6,7	70
SSH12.0X200	75170	12,0	200	110	17	6,7	

\*) Different head design.

### SSH – Characteristic Parameters

Reference	Characteristic Parameters				
	M <sub>y,k</sub> [Nmm]	f <sub>ax,k</sub> [N/mm <sup>2</sup> ]	f <sub>tens,k</sub> [kN]	f <sub>tor,k</sub> [Nm]	f <sub>head,k</sub> [N/mm <sup>2</sup> ]
SSH6.0	10400	13,3	13,1	11,0	17,9
SSH8.0	25300	13,9	24,1	26,4	19,5
SSH10.0	38700	12,1	32,8	43,0	19,3
SSH12.0	52300	12,2	40,4	62,4	18,8

f<sub>ax,k</sub> is the characteristic withdrawal parameter for timber with a characteristic density of 350 kg/m<sup>3</sup>

f<sub>head,k</sub> is the characteristic head pull through parameter for timber with a characteristic density of 350 kg/m<sup>3</sup> at max. 15 mm embedment.

Ratio of the characteristic torsional strength to the mean insertion moment: f<sub>tor,k</sub> / R<sub>tor,mean</sub> ≥ 1,5



Use Solid Wood to make your calculations.

Go to [solidwood.strongtie.eu](http://solidwood.strongtie.eu)

## Structural Fastening

# Solid-Drive™ SSF Flat Round-Head CONNECTOR Screw

*Simpson Strong-Tie® Connectors to Timber and General Steel to Timber Applications*

SSF is used together with connectors where high load capability is required. The conical shape under the head makes a perfect fitting to the connector hole, creating a firm assembly. The type-17 cut-point prevents cracking and the milling thread and serrated thread reduce the insertion torque. SSF has a round flat head with 6 lobe drive, creating an esthetically improved end-result.

These partially-threaded, sturdy 8.0 and 10.0 mm diameter structural fasteners are designed to provide excellent connection strength, especially when connecting steel plates or angle connectors to wood. The SSF screws are Impreg+ coated for increased corrosion protection.

**Codes/Standards:** ETA-21/0670

For more information, see page 234.

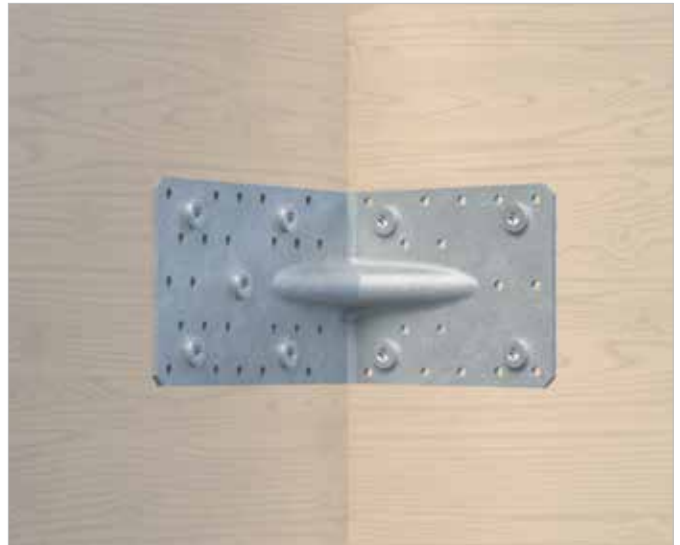

SSF screws fastening of E20/3 angle bracket.



SSF screws fastening of AB255SSH angle bracket.



ETA-21/0670

### Features





# Structural Fastening

## Solid-Drive™

### SSF Flat Round-Head CONNECTOR Screw

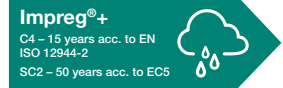
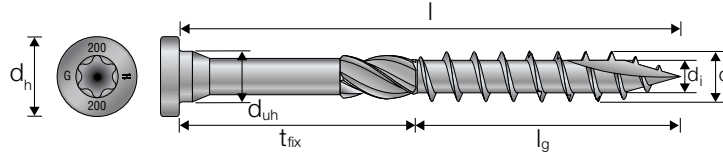

#### SSF – Range Overview

Reference	Article code	Dimensions [mm]					
		d/d <sub>uh</sub>	l	l <sub>g</sub>	d <sub>h</sub>	d <sub>i</sub>	t <sub>fix</sub>
SSF8.0X40	75185	8,0	40	32	13	5,1	8
SSF8.0X60	75186	8,0	60	42	13	5,1	18
SSF8.0X80	75187	8,0	80	42	13	5,1	38
SSF10.0X60	75189	10,0	60	42	15	6,15	18
SSF10.0X80	75190	10,0	80	42	15	6,15	38

#### SSF – Characteristic Parameters

Reference	Characteristic Parameters				
	M <sub>y,k</sub> [Nmm]	f <sub>ax,k</sub> [N/mm <sup>2</sup> ]	f <sub>tens,k</sub> [kN]	f <sub>tor,k</sub> [Nm]	f <sub>head,k</sub> [N/mm <sup>2</sup> ]
SSF8.0	25300	13,9	24,1	26,4	-
SSF10.0	38700	12,1	32,8	43,0	-



Use Solid Wood to make your calculations.

Go to [solidwood.strongtie.eu](http://solidwood.strongtie.eu)

f<sub>ax,k</sub> is the characteristic withdrawal parameter for timber with a characteristic density of 350 kg/m<sup>3</sup>

f<sub>head,k</sub> is the characteristic head pull through parameter for timber with a characteristic density of 350 kg/m<sup>3</sup> at max. 15 mm embedment.

Ratio of the characteristic torsional strength to the mean insertion moment: f<sub>tor,k</sub> / R<sub>tor,mean</sub> ≥ 1,5

# Structural Fastening

Fastener Types

## Solid-Drive™ ESCRFTC Full-Threaded Countersunk WOOD Screw

*Structural Timber to Timber Connections Including Glulam Seat Reinforcement and CLT Applications*

The Solid-Drive® ESCRFTC wood screw is a structural fastener available in a variety of lengths and is designed for cross-laminated timber (CLT), glulam construction, beam reinforcement and general interior applications.

These full-threaded 8.0, 10.0 and 12.0 diameter [mm] structural fasteners are designed to pull structural members together with superb holding power and excellent load capacity. The half-cut point makes it easy to fix the screw in the correct angle and thereby ensure that inclined screws are installed with the correct angle. The countersunk head and underhead nibs provide for clean countersinking, flush with the surface. Predrilling is not typically required. For interior and dry applications only.

**Codes/Standards:** ETA-13/0796

**For more information,** see pages 102, 145, 171, 203, 251.



ESCRFTC screws in seat reinforcement application with additional steel plate.



ETA-13/0796

### Features



**Deep 6-lobe recess** provides improved control and greater bit life

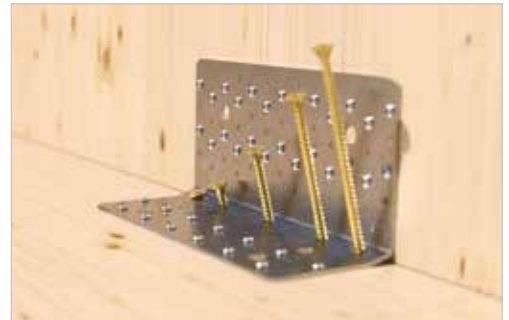

ESCRFTC screws fastening of AB255HD heavy-duty angle bracket.

# Structural Fastening

## Solid-Drive™ ESCRFTC Full-Threaded Countersunk WOOD Screw

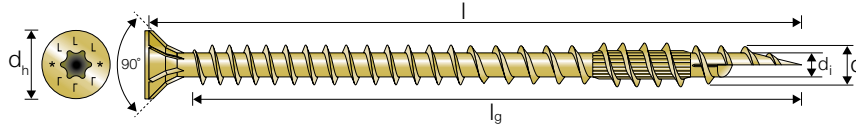
**Yellow Zinc Plated**

 C2 acc. to EN ISO 12944-2  
 SC2 – 50 years acc. to ECS

### ESCRFTC – Range Overview

Reference	Dimensions [mm]				
	d	l	l <sub>g</sub>	d <sub>h</sub>	d <sub>i</sub>
ESCRFTC8.0X120	8.0	120	110	15.0	5,2
ESCRFTC8.0X140	8.0	140	130	15.0	5,2
ESCRFTC8.0X160	8.0	160	150	15.0	5,2
ESCRFTC8.0X180	8.0	180	170	15.0	5,2
ESCRFTC8.0X200	8.0	200	190	15.0	5,2
ESCRFTC8.0X220	8.0	220	210	15.0	5,2
ESCRFTC8.0X240	8.0	240	230	15.0	5,2
ESCRFTC8.0X260	8.0	260	250	15.0	6,1
ESCRFTC8.0X280	8.0	280	270	15.0	6,1
ESCRFTC8.0X300	8.0	300	290	15.0	6,1
ESCRFTC8.0X350	8.0	350	340	15.0	6,1
ESCRFTC8.0X400	8.0	400	390	15.0	6,1
ESCRFTC8.0X450	8.0	450	427	15.0	6,1
ESCRFTC10.0X120	10.0	120	108	18.5	6,8
ESCRFTC10.0X160	10.0	160	148	18.5	6,8
ESCRFTC10.0X180	10.0	180	168	18.5	6,8
ESCRFTC10.0X200	10.0	200	188	18.5	6,8
ESCRFTC10.0X220	10.0	220	208	18.5	6,8
ESCRFTC10.0X240	10.0	240	228	18.5	6,8
ESCRFTC10.0X260	10.0	260	248	18.5	6,8
ESCRFTC10.0X280	10.0	280	268	18.5	6,8
ESCRFTC10.0X300	10.0	300	288	18.5	6,8
ESCRFTC10.0X350	10.0	350	338	18.5	6,8
ESCRFTC10.0X400	10.0	400	388	18.5	6,8
ESCRFTC10.0X450	10.0	450	426	18.5	6,8
ESCRFTC12.0X200	12.0	200	180	20.0	
ESCRFTC12.0X220	12.0	220	200	20.0	
ESCRFTC12.0X240	12.0	240	220	20.0	
ESCRFTC12.0X260	12.0	260	240	20.0	
ESCRFTC12.0X280	12.0	280	260	20.0	
ESCRFTC12.0X300	12.0	300	280	20.0	
ESCRFTC12.0X350	12.0	350	330	20.0	
ESCRFTC12.0X400	12.0	400	380	20.0	
ESCRFTC12.0X450	12.0	450	430	20.0	
ESCRFTC12.0X500	12.0	500	480	20.0	
ESCRFTC12.0X600	12.0	600	580	20.0	

### ESCRFTC – Characteristic Parameters

Reference	Characteristic Parameters					
	M <sub>y,k</sub> [Nmm]	f <sub>ax,k</sub> [N/mm <sup>2</sup> ]	f <sub>tens,k</sub> [kN]	f <sub>tor,k</sub> [Nm]	f <sub>head,k</sub> [N/mm <sup>2</sup> ]	f <sub>y,k</sub> [N/mm <sup>2</sup> ]
ESCRFTC8.0	20300	13,1	24,1	25,8	12,4	950
ESCRFTC10.0	36700	12,5	40,0	55,0	12,2	950
ESCRFTC12.0	48500	11,2	46,7	73,0	10,3	950

f<sub>ax,k</sub> is the characteristic withdrawal parameter for timber with a characteristic density of 350 kg/m<sup>3</sup>

f<sub>head,k</sub> is the characteristic head pull through parameter for timber with a characteristic density of 350 kg/m<sup>3</sup> at max. 15 mm embedment.

Ratio of the characteristic torsional strength to the mean insertion moment: f<sub>tor,k</sub> / R<sub>tor,mean</sub> ≥ 1,5

 Use Solid Wood to  
 make your calculations.

 Go to  
[solidwood.strongtie.eu](http://solidwood.strongtie.eu)

# Structural Fastening

Fastener Types

## Solid-Drive™ ESCRFTZ Full-Threaded Cylinder-Head WOOD Screw

*Structural Timber to Timber Connections Including Glulam, CLT and General Interior Applications*

The Solid-Drive® ESCRFTZ wood screws are structural fasteners available in a variety of lengths and are designed for cross-laminated timber (CLT), glulam construction, beam reinforcement and general interior applications.

These full-threaded 8.0 diameter [mm] structural fasteners are designed to pull structural members together with superb holding power and excellent load capacity. The cylinder-head allows for deep countersinking and inclined installations. Predrilling is not typically required. For interior and dry applications only.

**Codes/Standards:** ETA-13/0796

**For more information,** see pages 107, 150, 161, 166, 202, 241, 218, 221.



ESCRFTZ screws installed into a CLT floor on joists.



ETA-13/0796

### Features

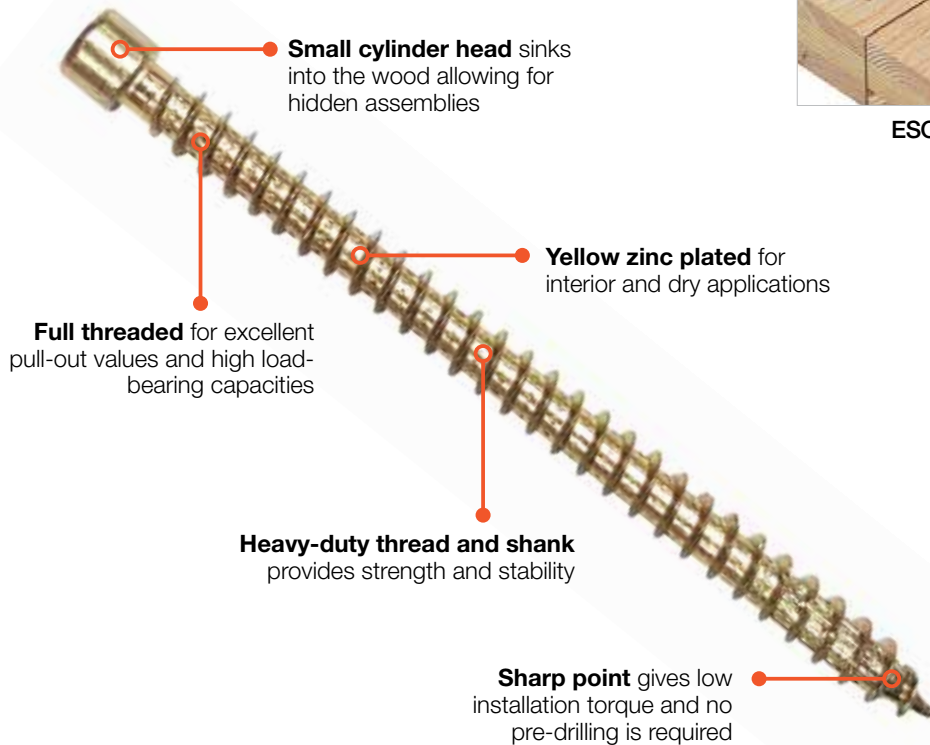

ESCRFTZ screws in installation of CLT butt-joint application.



Use the **GSCREW** screw guide to install ESCRFTZ in inclined and angled installations.

# Structural Fastening

## Solid-Drive™

### ESCRFTZ Full-Threaded Cylinder-Head WOOD Screw

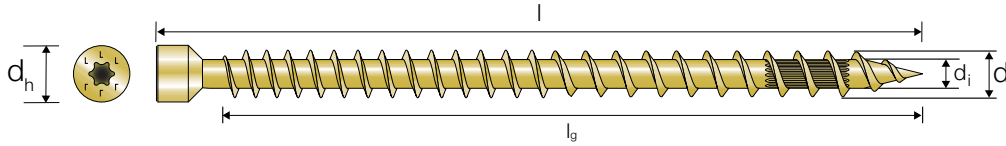

**Yellow Zinc Plated**

C2 acc. to EN ISO 12944-2  
SC2 - 50 years acc. to EC5

#### ESCRFTZ – Range Overview

Reference	Dimensions [mm]				
	d	l	l <sub>g</sub>	d <sub>h</sub>	d <sub>i</sub>
ESCRFTZ8.0X120	8.0	120	110	10,2	5,2
ESCRFTZ8.0X140	8.0	140	130	10,2	5,2
ESCRFTZ8.0X160	8.0	160	150	10,2	5,2
ESCRFTZ8.0X180	8.0	180	170	10,2	5,2
ESCRFTZ8.0X200	8.0	200	190	10,2	5,2
ESCRFTZ8.0X220	8.0	220	210	10,2	5,2
ESCRFTZ8.0X240	8.0	240	230	10,2	5,2
ESCRFTZ8.0X260	8.0	260	250	10,2	5,2
ESCRFTZ8.0X280	8.0	280	270	10,2	5,2
ESCRFTZ8.0X300	8.0	300	290	10,2	5,2
ESCRFTZ8.0X350	8.0	350	340	10,2	5,2
ESCRFTZ8.0X400	8.0	400	390	10,2	5,2

#### ESCRFTZ – Characteristic Parameters

Reference	Characteristic Parameters					
	M <sub>y,k</sub> [Nmm]	f <sub>ax,k</sub> [N/mm <sup>2</sup> ]	f <sub>tens,k</sub> [kN]	f <sub>tor,k</sub> [Nm]	f <sub>head,k</sub> [N/mm <sup>2</sup> ]	f <sub>y,k</sub> [N/mm <sup>2</sup> ]
ESCRFTZ8.0	20300	13,1	24,1	25,8	-	950

f<sub>ax,k</sub> is the characteristic withdrawal parameter for timber with a characteristic density of 350 kg/m<sup>3</sup>

f<sub>head,k</sub> is the characteristic head pull through parameter for timber with a characteristic density of 350 kg/m<sup>3</sup> at max. 15 mm embedment.

Ratio of the characteristic torsional strength to the mean insertion moment: f<sub>tor,k</sub> / R<sub>tor,mean</sub> ≥ 1,5



Use Solid Wood to make your calculations.

Go to [solidwood.strongtie.eu](http://solidwood.strongtie.eu)

# Structural Fastening

Fastener Types

## Solid-Drive™ ESCRFT Full-Threaded Cylinder-Head WOOD Screw

*Structural Timber to Timber Connections Including Glulam and CLT Cross Pair Applications*

The Solid-Drive® ESCRFT wood screws are structural fasteners available in lengths up to 1000 [mm] and are designed for cross-laminated timber (CLT), glulam construction, beam reinforcement and general interior applications.

These full-threaded 10.0 mm diameter structural fasteners are designed to pull structural members together with superb holding power and excellent load capacity. The half-cut point makes it easy to fix the screw in the correct angle and thereby ensure that inclined screws are installed with the correct angle. The cylinder-head allows for deep countersinking and inclined installations. Predrilling is not typically required. For interior and dry applications only.

**Codes/Standards:** ETA-13/0796

**For more information,** see pages 109, 152, 162, 167, 193, 204, 215, 219, 222.

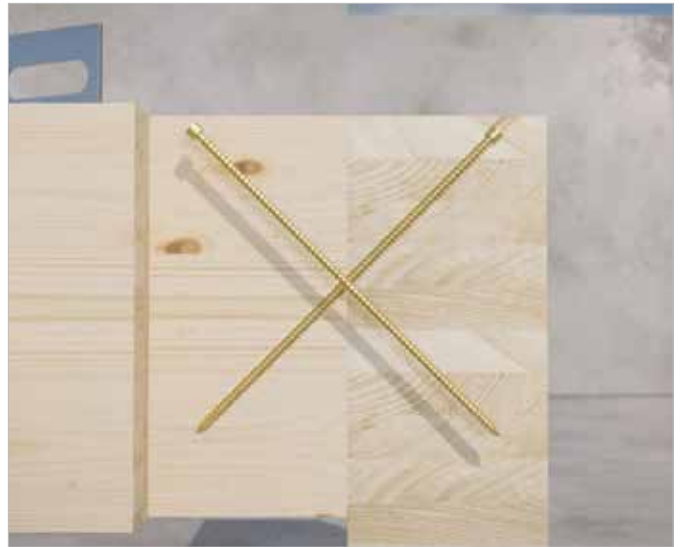

ESCRFT screws in glulam cross pair application.



ETA-13/0796

### Features

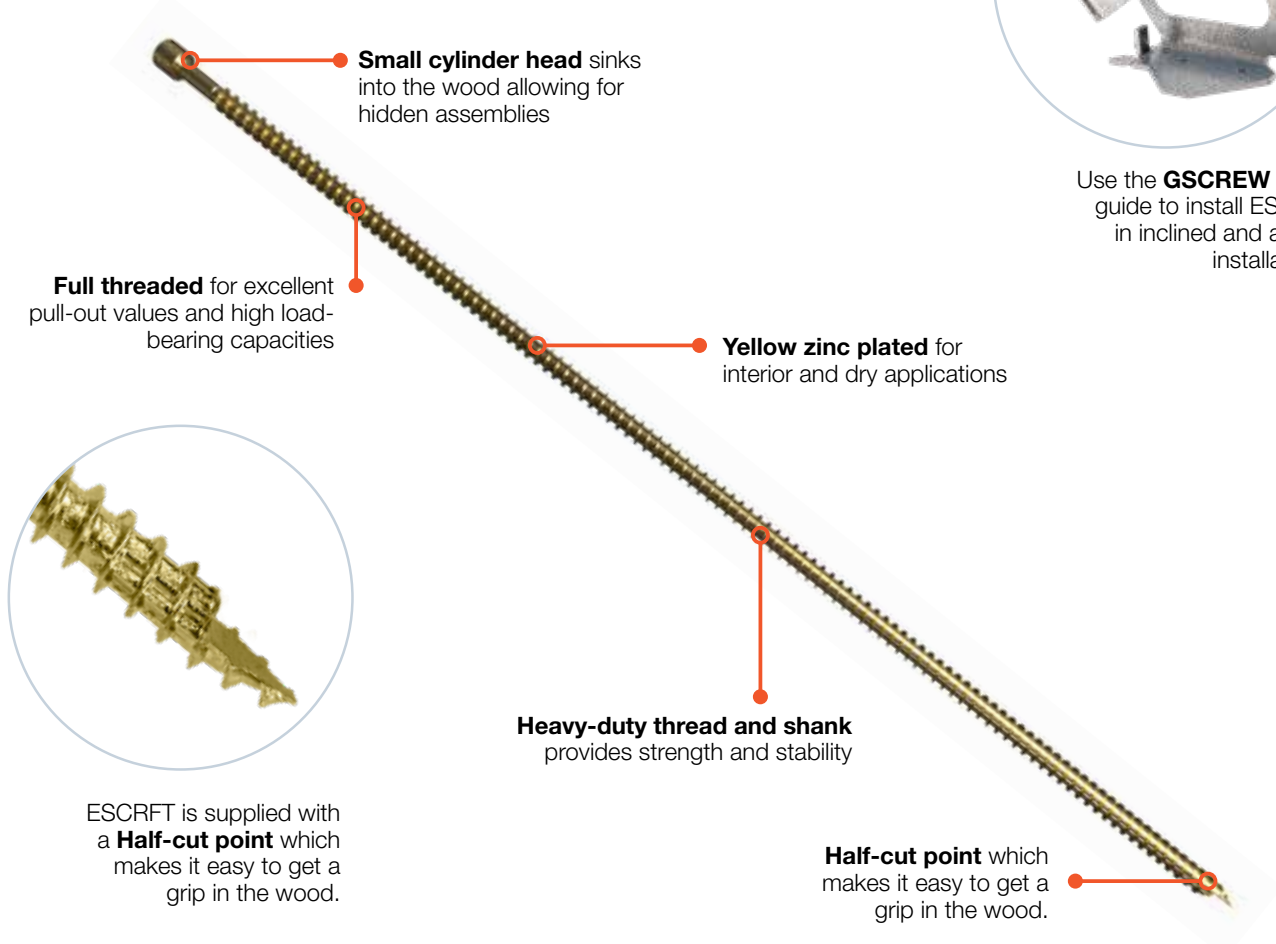

**Small cylinder head** sinks into the wood allowing for hidden assemblies

**Full threaded** for excellent pull-out values and high load-bearing capacities

**Yellow zinc plated** for interior and dry applications

**Heavy-duty thread and shank** provides strength and stability

ESCRFT is supplied with a **Half-cut point** which makes it easy to get a grip in the wood.

**Half-cut point** which makes it easy to get a grip in the wood.



Use the **GSCREW** screw guide to install ESCRFT in inclined and angled installations.



# Structural Fastening

## Solid-Drive™

### ESCRFT Full-Threaded Cylinder-Head WOOD Screw

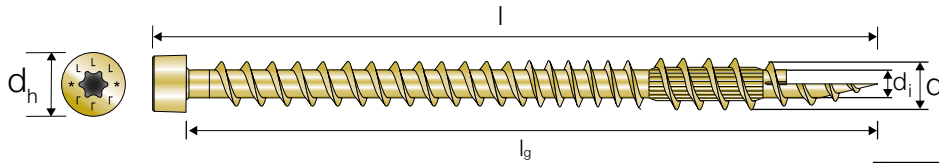

**Yellow Zinc Plated**

C2 acc. to EN ISO 12944-2  
SC2 - 50 years acc. to EC5

#### ESCRFT – Range Overview

Reference	Dimensions [mm]				
	d	l	l <sub>g</sub>	d <sub>h</sub>	d <sub>i</sub>
ESCRFT10.0X450	10,0	450	426	13,4	6,1
ESCRFT10.0X500	10,0	500	476	13,4	6,1
ESCRFT10.0X600	10,0	600	576	13,4	6,1
ESCRFT10.0X800	10,0	800	776	13,4	6,1
ESCRFT10.0X1000	10,0	1000	976	13,4	6,1

#### ESCRFT – Characteristic Parameters

Reference	Characteristic Parameters					
	M <sub>y,k</sub> [Nmm]	f <sub>ax,k</sub> [N/mm <sup>2</sup> ]	f <sub>tens,k</sub> [kN]	f <sub>tor,k</sub> [Nm]	f <sub>head,k</sub> [N/mm <sup>2</sup> ]	f <sub>y,k</sub> [N/mm <sup>2</sup> ]
ESCRFT10.0	36700	12,5	40,0	55,0	-	950

f<sub>ax,k</sub> is the characteristic withdrawal parameter for timber with a characteristic density of 350 kg/m<sup>3</sup>

f<sub>head,k</sub> is the characteristic head pull through parameter for timber with a characteristic density of 350 kg/m<sup>3</sup> at max. 15 mm embedment.

Ratio of the characteristic torsional strength to the mean insertion moment: f<sub>tor,k</sub> / R<sub>tor,mean</sub> ≥ 1,5



Use Solid Wood to make your calculations.

Go to [solidwood.strongtie.eu](http://solidwood.strongtie.eu)

## Structural Fastening

# Solid-Drive™ ESCRT2R Double-Threaded Cylinder Head WOOD Screw

### Structural Timber to Timber Connections Including Rafter-Insulation Applications

The Solid-Drive ESCRT2R screw is the ideal fixing option for rafter insulation. The screw can absorb shear and compressive forces and by doing so, the insulation material is pressed significantly less to the background, thereby improving the insulation performance.

The double-coarse thread with differentiated thread pitch creates a clamping effect and pulls the wood members together. The small cylinder head reduces the insertion torque and makes it possible to countersink the screws.

ESCRT2R screws are suitable for inclined and angled installations. Use the GSCREW screw guide to ensure that screws are installed with the correct angle into the timber.

**Codes/Standards:** ETA-13/0796

**For more information,** see our website [strongtie.eu](http://strongtie.eu) (characteristic values for rafter insulation are not included in this catalogue, but you can find it on our website).

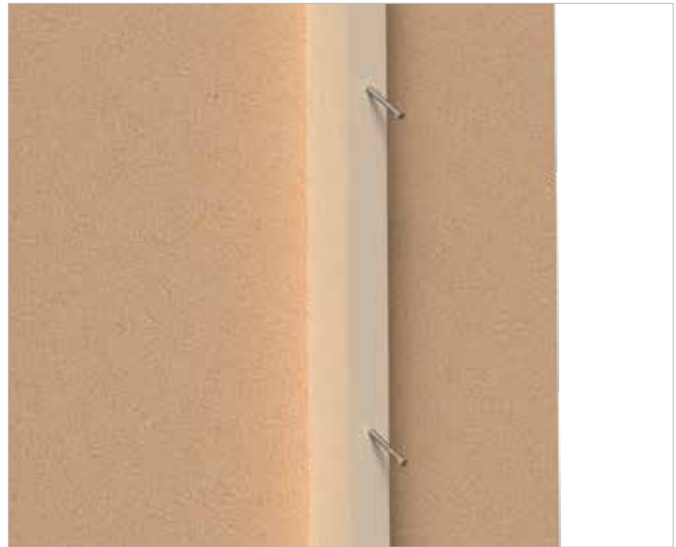

ESCRT2R screws in rafter insulation application.



ESCRT2R screws in rafter insulation application.



ETA-13/0796

### Features

**Small cylinder head** sinks into the wood allowing for hidden assemblies

**Double coarse threaded shank** pulls together the wood members

**Milling thread** reduces the drive-in torque

**Sharp point and secondary thread** gives low installation torque and no pre-drilling is required



Use the **GSCREW** screw guide to install ESCRT2R in inclined and angled roof and wall insulation installations.

## Structural Fastening

### Solid-Drive™

## ESCRT2R Double-Threaded Cylinder Head WOOD Screw

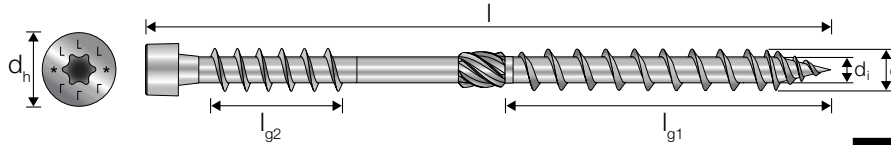
**Electro Galvanised**

 C1 acc. to EN ISO 12944-2  
 SC2 – 50 years acc. to EC5

### ESCRT2R – Range Overview

Reference	Dimensions [mm]					
	d	l	l <sub>g1</sub>	l <sub>g2</sub>	d <sub>h</sub>	d <sub>i</sub>
ESCRT2R8.0X240	8,0	240	84	80	10,2	5,3
ESCRT2R8.0X260	8,0	260	100	80	10,2	5,3
ESCRT2R8.0X280	8,0	280	100	80	10,2	5,3
ESCRT2R8.0X300	8,0	300	100	80	10,2	5,3
ESCRT2R8.0X320	8,0	320	100	80	10,2	5,3
ESCRT2R8.0X340	8,0	340	100	80	10,2	5,3
ESCRT2R8.0X360	8,0	360	100	80	10,2	5,3
ESCRT2R8.0X400	8,0	400	100	80	10,2	5,3
ESCRT2R8.0X450	8,0	450	100	80	10,2	5,3

### ESCRT2R – Characteristic Parameters

Reference	Characteristic Parameters					
	M <sub>y,k</sub> [Nmm]	f <sub>ax,k</sub> [N/mm <sup>2</sup> ]	f <sub>tens,k</sub> [kN]	f <sub>tor,k</sub> [Nm]	f <sub>head,k</sub> [N/mm <sup>2</sup> ]	f <sub>y,k</sub> [N/mm <sup>2</sup> ]
ESCRT2R8.0	22600	10,7	22,0	24,8	-	900

f<sub>ax,k</sub> is the characteristic withdrawal parameter for timber with a characteristic density of 350 kg/m<sup>3</sup>

f<sub>head,k</sub> is the characteristic head pull through parameter for timber with a characteristic density of 350 kg/m<sup>3</sup> at max. 15 mm embedment.

Ratio of the characteristic torsional strength to the mean insertion moment: f<sub>tor,k</sub> / R<sub>tor,mean</sub> ≥ 1,5



Use Solid Wood to make your calculations.

 Go to [solidwood.strongtie.eu](http://solidwood.strongtie.eu)

# Structural Fastening

Fastener Types

## Solid-Drive™ CSA/CSA-Z/CSA-S CONNECTOR Screw

### Simpson Strong-Tie® Connectors to Timber

The Solid-Drive™ CSA connector screw is developed for installing of Simpson Strong-Tie® connectors to wood, in order to obtain the published load bearing capacities.

The conical shape under the head secures full contact to the connector, which increases the transfer of force. A fixed connection with larger cross-bearing capacity than for standard screws is obtained. The 6 lobe recess helps to fix the screw during insertion.

With the Quik Drive collated CSA screws, Simpson Strong-Tie offers an extremely efficient method for installing connectors to CLT and glulam. CLT connectors often require many screws per installation, so by using the Quik Drive system, the installer can save considerable time.

**Codes/Standards:** ETA-04/0013

**For more information,** see page 236.



Quik Drive collated CSA screws fastening HTT31 holdown in CLT wall to concrete slab installation.



### Features

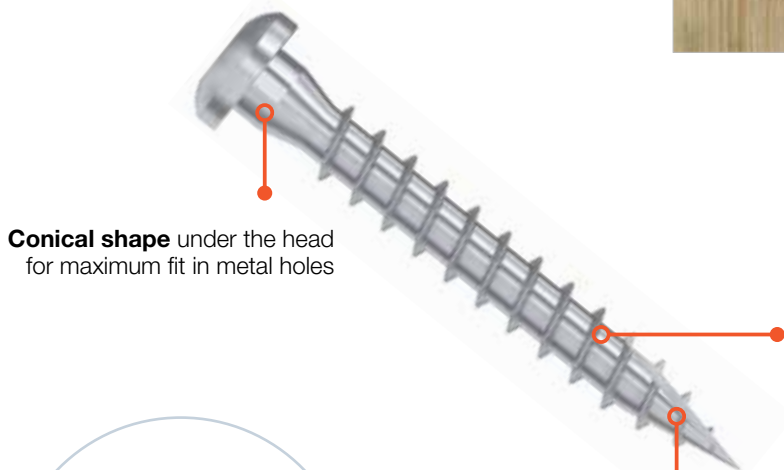

**Conical shape** under the head for maximum fit in metal holes

Available as electro galvanised or with Impreg+ coating and in stainless steel A4.

**Type 17 cut point** reduces the risk of wood splitting during the installation



**Deep 6-lobe recess** provides improved control and greater bit life

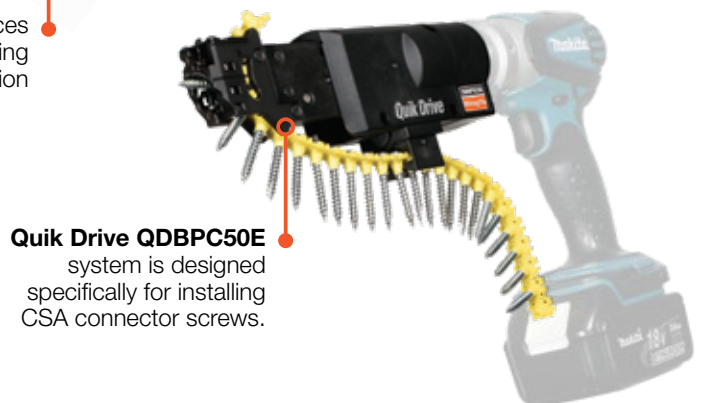

**Quik Drive QDBPC50E** system is designed specifically for installing CSA connector screws.

# Structural Fastening

## Solid-Drive™ CSA/CSA-Z/CSA-S CONNECTOR Screws

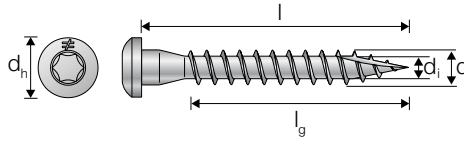

**Electro Galvanised**

C1 acc. to EN ISO 12944-2  
SC2 – 50 years acc. to EC5

### CSA – Range Overview

Reference	Dimensions [mm]				
	d	l	l <sub>g</sub>	d <sub>h</sub>	d <sub>i</sub>
CSA5.0X25	4,85	25	19	8,3	3,15
CSA5.0X35	4,85	35	29	8,3	3,15
CSA5.0X40	4,85	40	34	8,3	3,15
CSA5.0X50	4,85	50	44	8,3	3,15
CSA5.0X80	4,85	80	74	8,3	3,15

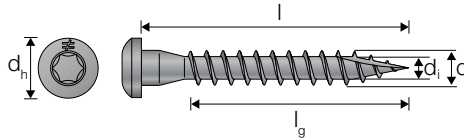

**Impreg®+**

C4 – 15 years acc. to EN ISO 12944-2  
SC2 – 50 years acc. to EC5

### CSA-Z – Range Overview

Reference	Dimensions [mm]				
	d	l	l <sub>g</sub>	d <sub>h</sub>	d <sub>i</sub>
CSA5.0X35Z	4,85	35	29	8,3	3,15
CSA5.0X40Z	4,85	40	34	8,3	3,15
CSA5.0X50Z	4,85	50	44	8,3	3,15

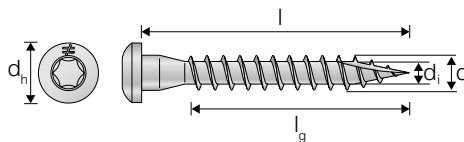

**Stainless Steel**

C5 acc. to EN ISO 12944-2  
SC3 – 50 years acc. to EC5



### CSA-S – Range Overview

Reference	Dimensions [mm]				
	d	l	l <sub>g</sub>	d <sub>h</sub>	d <sub>i</sub>
CSA5.0X25S	4,85	25	19	8,3	3,15
CSA5.0X35S	4,85	35	29	8,3	3,15
CSA5.0X40S	4,85	40	34	8,3	3,15

### CSA/CSA-Z/CSA-S – Characteristic Parameters

Reference	Characteristic Parameters				
	M <sub>y,k</sub> [Nmm]	f <sub>ax,k</sub> [N/mm <sup>2</sup> ]	f <sub>tens,k</sub> [kN]	f <sub>tor,k</sub> [Nm]	f <sub>head,k</sub> [N/mm <sup>2</sup> ]
CSA5.0	5000	15,0	6,8	-	-

f<sub>ax,k</sub> is the characteristic withdrawal parameter for timber with a characteristic density of 350 kg/m<sup>3</sup>

f<sub>head,k</sub> is the characteristic head pull through parameter for timber with a characteristic density of 350 kg/m<sup>3</sup> at max. 15 mm embedment.

Ratio of the characteristic torsional strength to the mean insertion moment: f<sub>tor,k</sub> / R<sub>tor,mean</sub> ≥ 1,5



Use Solid Wood to make your calculations.

Go to [solidwood.strongtie.eu](http://solidwood.strongtie.eu)

# Structural Fastening

Fastener Types

## Solid-Drive™ CNA/CNA-G/CNA-S CONNECTOR Nail

### Simpson Strong-Tie® Connectors to Timber

The Solid-Drive CNA connector nail, which is supplied in many different lengths and sizes, loose and collated, is a fully documented ETA-approved fastener used for installing metal connectors to wood. Guaranteed load bearing capacities when using CNA nails to install Simpson Strong-Tie connectors.

CNA is available in a variety of different collations and is compatible with many pneumatic and gas-driven tools on the market. The collated nails are available as 34° plastic collated and 34° paper collated as well as 15° plastic coil collated.

**Codes/Standards:** ETA-04/0013

**For more information,** see page 239.



CNA connectors nails used in various connector applications



ETA-04/0013



### Features

**Conical shape** under the head for maximum fit in metal holes

**Ring-shank** increases the pull-out resistance

**Head-stamp** makes it easy to identify the length after installation.



Available as electro galvanised, hot-dip galvanised and in stainless steel A4.

Available in different types of collations:

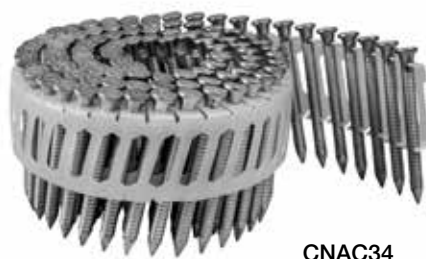



# Structural Fastening

## Solid-Drive™ CNA/CNA-G/CNA-S CONNECTOR Nail

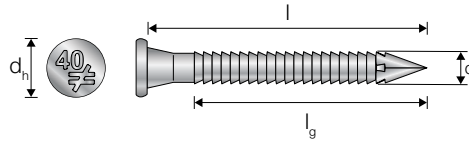

**Electro Galvanised**

C1 acc. to EN ISO 12944-2  
SC2 – 50 years acc. to EC5

### CNA – Range Overview

Reference	Dimensions [mm]			
	d	l	l <sub>g</sub>	d <sub>h</sub>
CNA4.0X35	4,4	35	20	7
CNA4.0X40	4,4	40	25	7
CNA4.0X50	4,4	50	35	7
CNA4.0X60	4,4	60	45	7
CNA4.0X75	4,4	75	59	7
CNA4.0X100	4,4	100	65	7

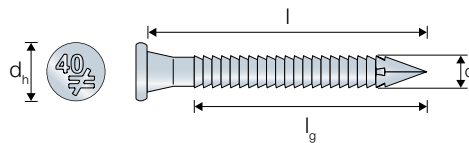

**Hot-Dip Galvanised**

C4 acc. to EN ISO 12944-2  
SC3 – 50 years acc. to EC5

### CNA-G – Range Overview

Reference	Dimensions [mm]			
	d	l	l <sub>g</sub>	d <sub>h</sub>
CNA4.0X40G	4,4	40	40	7

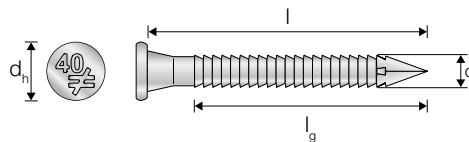

**Stainless Steel**

C5 acc. to EN ISO 12944-2  
SC3 – 50 years acc. to EC5



### CNA-S – Range Overview

Reference	Dimensions [mm]			
	d	l	l <sub>g</sub>	d <sub>h</sub>
CNA4.0X35S	4,4	35	20	7
CNA4.0X40S	4,4	40	25	7
CNA4.0X50S	4,4	50	35	7
CNA4.0X60S	4,4	60	45	7

### CNA/CNA-G/CNA-S – Characteristic Parameters

Reference	Characteristic Parameters				
	M <sub>y,k</sub> [Nmm]	f <sub>ax,k</sub> [N/mm²]	f <sub>tens,k</sub> [kN]	f <sub>tor,k</sub> [Nm]	f <sub>head,k</sub> [N/mm²]
CNA4.0	6617	*	7,5	-	-

f<sub>ax,k</sub> is the characteristic withdrawal parameter for timber with a characteristic density of 350 kg/m³

f<sub>head,k</sub> is the characteristic head pull through parameter for timber with a characteristic density of 350 kg/m³ at max. 15 mm embedment.

Ratio of the characteristic torsional strength to the mean insertion moment: f<sub>tor,k</sub> / R<sub>tor,mean</sub> ≥ 1,5



Use Solid Wood to make your calculations.

Go to [solidwood.strongtie.eu](http://solidwood.strongtie.eu)

# Structural Fastening

## Solid-Drive™ WSV Quik Drive® Collated WOOD Screw

*Structural Timber to Timber Connections and General Interior Applications*

The Quik Drive collated WSV wood screw has been developed for quick and reliable fastening of timber to timber using the Quik Drive auto-feed screw driving system.

The point and thread pattern provides easy starts and less torque, which leads to faster driving. This also means less wear on tools.

The deep 6-lobe recess and ribbed underhead provide secure bit retention and clean countersinking.

**Codes/Standards:** EN14592

**For more information,** see pages 225, 256.



WSV screws in CLT spline application.



### Features

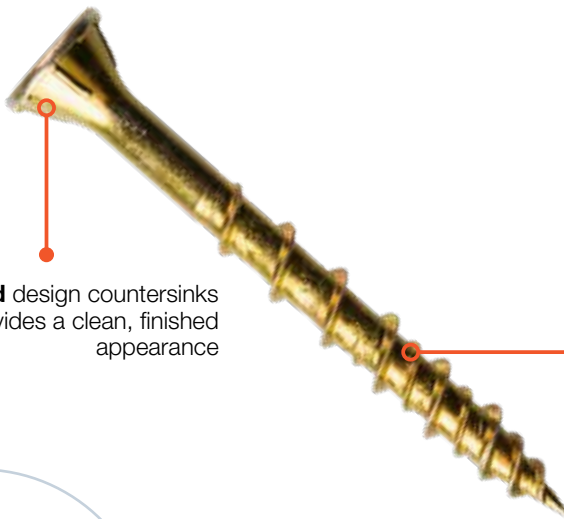

**Ribbed head** design countersinks easily and provides a clean, finished appearance



**Quik Drive QDPRO76SKE** system is designed for efficient installation of timber screws.

Aggressive **variable thread** provides lower driving torque, resulting in faster, easier driving



**Deep 6-lobe recess** provides improved control and greater bit life

Collated with patented curved **Quik Drive Strip:**



## Structural Fastening

# Solid-Drive™ WSV Quik Drive® Collated WOOD Screw

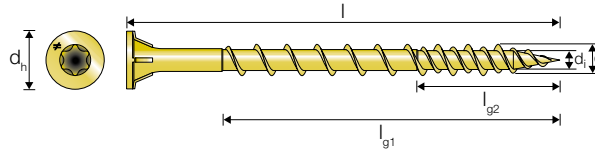

**Yellow Zinc Plated**

C2 acc. to EN ISO 12944-2  
SC2 - 50 years acc. to EC5

### WSV – Range Overview

Reference	Dimensions [mm]					
	d	l	l <sub>g1</sub>	l <sub>g2</sub>	d <sub>h</sub>	d <sub>i</sub>
WSV44E	4,6	44	31	18	8,5	3,1
WSV51E	4,6	51	37	21	8,5	3,1
WSV64E	4,6	64	50	21	8,5	3,1
WSV76E	4,6	76	55	21	8,5	3,1

### WSV – Characteristic Parameters

Reference	Characteristic Parameters					
	M <sub>y,k</sub> [Nmm]	f <sub>ax,k</sub> [N/mm <sup>2</sup> ]	f <sub>tens,k</sub> [kN]	f <sub>tor,k</sub> [Nm]	f <sub>head,k</sub> [N/mm <sup>2</sup> ]	f <sub>y,k</sub> [N/mm <sup>2</sup> ]
WSV4.6	3500	14,7	8,2	6,1	31,3	900

f<sub>ax,k</sub> is the characteristic withdrawal parameter for timber with a characteristic density of 350 kg/m<sup>3</sup>

f<sub>head,k</sub> is the characteristic head pull through parameter for timber with a characteristic density of 350 kg/m<sup>3</sup> at max. 15 mm embedment.

Ratio of the characteristic torsional strength to the mean insertion moment: f<sub>tor,k</sub> / R<sub>tor,mean</sub> ≥ 1,5

# Structural Fastening

Fastener Types

## Solid-Drive™ SDW/SDWS Structural WOOD Screw

*Structural Timber to Timber Connections and General Interior (SDW) and Exterior (SDWS) Applications*

SDW/SDWS are structural wood screws available in a variety of lengths and are designed for cross-laminated timber assemblies, mass timber construction, log-home construction, ledgers and general interior applications.

These structural fasteners require less torque to install than comparable fasteners, and the large-diameter washer head pulls members down easily, eliminating the need to use extra washers.

**Codes/Standards:** EN14592

**For more information,** see pages 112, 114, 157.



SDWS in ledger application.



EN14592



### Features

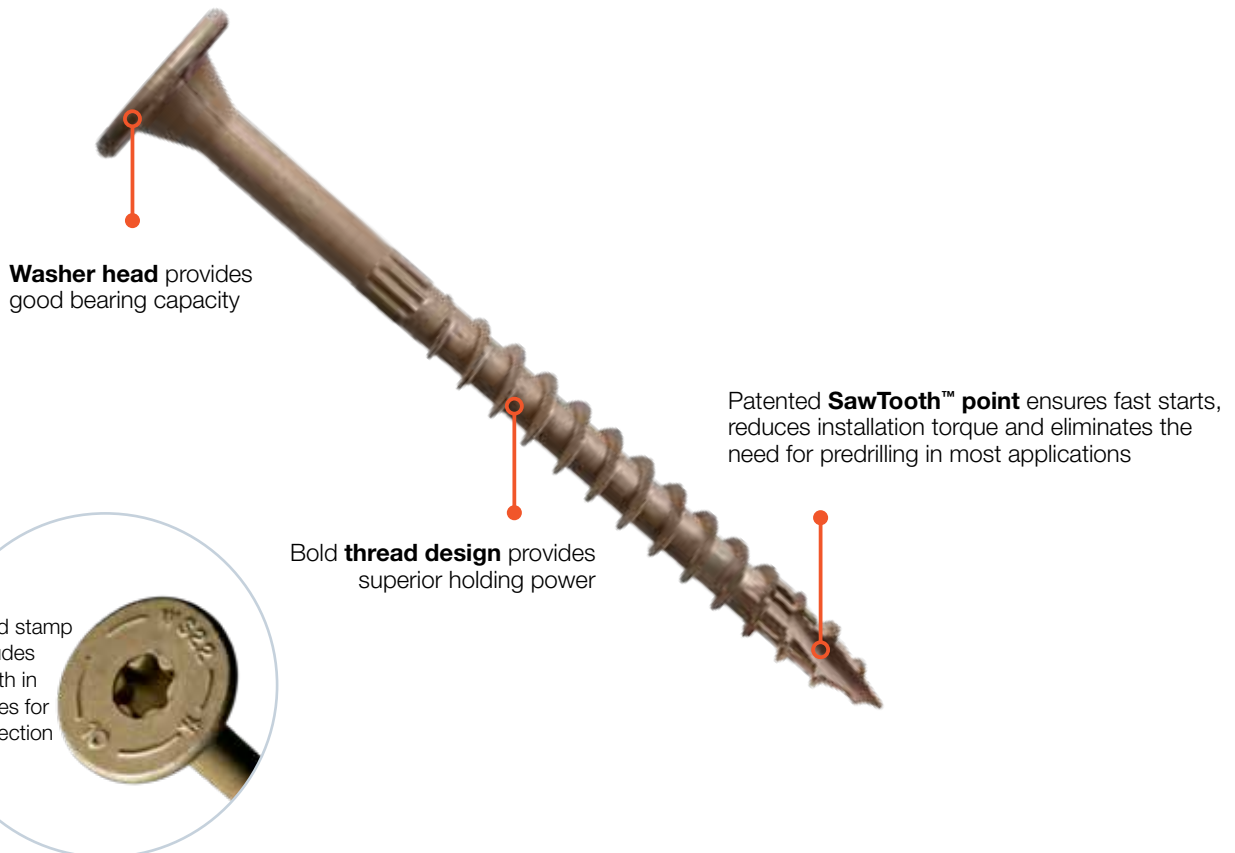

**Washer head** provides good bearing capacity

Patented **SawTooth™** point ensures fast starts, reduces installation torque and eliminates the need for predrilling in most applications

**Bold thread design** provides superior holding power

Head stamp includes length in inches for inspection

**Deep 6-lobe recess** provides improved control and greater bit life

# Structural Fastening

## Solid-Drive™ SDW/SDWS Structural WOOD Screw

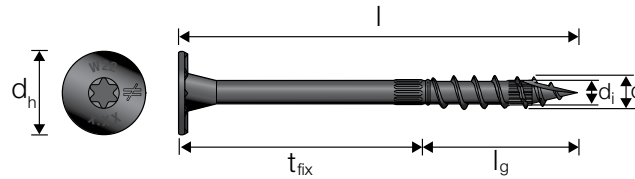

### Electrocoat

C2 acc. to EN ISO 12944-2  
SC2 – 50 years acc. to EC5

### SDW – Range Overview

Reference	Dimensions [mm]					
	d	l	l <sub>g</sub>	d <sub>h</sub>	d <sub>i</sub>	t <sub>fix</sub>
SDW22258-R50E	8,0	66	36	19	5,6	30
SDW22300-R50E	8,0	76	37	19	5,6	39
SDW22338-R50E	8,0	86	40	19	5,6	46
SDW22438-R50E	8,0	111	37	19	5,6	74
SDW22458-R50E	8,0	117	37	19	5,6	80
SDW22500-R50E	8,0	127	40	19	5,6	87
SDW22600-R50E	8,0	152	37	19	5,6	115
SDW22638-R50E	8,0	162	37	19	5,6	125
SDW22634-R50E	8,0	172	40	19	5,6	132

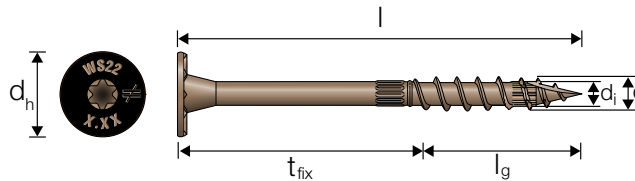

### Double Barrier

C3 acc. to EN ISO 12944-2  
SC3 – 50 years acc. to EC5

### SDWS – Range Overview

Reference	Dimensions [mm]					
	d	l	l <sub>g</sub>	d <sub>h</sub>	d <sub>i</sub>	t <sub>fix</sub>
SDWS22300DB-R50	8,0	75	37	19,4	5,2	38
SDWS22400DB-R50	8,0	100	59	19,4	5,2	41
SDWS22500DB-R50	8,0	126	69	19,4	5,2	57
SDWS22600DB-R50	8,0	151	69	19,4	5,2	82
SDWS22800DB-R50	8,0	202	69	19,4	5,2	133
SDWS221000DB-R50	8,0	252	69	19,4	5,2	183

### SDW/SDWS – Characteristic Parameters

Reference	Characteristic Parameters				
	M <sub>y,k</sub> [Nmm]	f <sub>ax,k</sub> [N/mm <sup>2</sup> ]	f <sub>tens,k</sub> [kN]	f <sub>tor,k</sub> [Nm]	f <sub>head,k</sub> [N/mm <sup>2</sup> ]
SDW/SDWS8.0	17400	13,2	21,4	24,2	21,4

f<sub>ax,k</sub> is the characteristic withdrawal parameter for timber with a characteristic density of 350 kg/m<sup>3</sup>

f<sub>head,k</sub> is the characteristic head pull through parameter for timber with a characteristic density of 350 kg/m<sup>3</sup> at max. 15 mm embedment.

Ratio of the characteristic torsional strength to the mean insertion moment: f<sub>tor,k</sub> / R<sub>tor,mean</sub> ≥ 1,5



Use Solid Wood to make your calculations.

Go to [solidwood.strongtie.eu](http://solidwood.strongtie.eu)





**We help you build safer,  
stronger structures.**



# Timber to Timber Fastening

## 3.1 Solid Timber Fastening

TTUFS, TTZNFS, TTSFS	74
SWW, SWWZ	81
SWC	89
SWD	94
SSH	97
ESCRFTC, ESCRFTZ	102
ESCRFT	109
SDW, SDWS	112

## 3.2 Glulam Fastening

TTUFS, TTZNFS, TTSFS	119
SWW, SWWZ	126
SWC	134
SWD	139
SSH	142
ESCRFT	145
ESCRFTC, ESCRFTZ	150
SDW, SDWS	155

### 3.2.1 Glulam Inclined Installations

SWD	160
ESCRFTZ	161
ESCRFT	162

### 3.2.2 Glulam Cross Pairs

SWD	165
ESCRFTZ	166
ESCRFT	167

### 3.2.3 Glulam Reinforcement

ESCRFTC	171
---------	-----

## 3.3 CLT Fastening

### 3.3.1 90° T-Connections between CLT Panels

TTUFS	183
SWW, SWWZ	184
SWC	187
SWD	191
ESCRFTZ, ESCRFTC	192

### 3.3.2 Solid-Timber Wall-Plate to CLT Panel Connections

TTUFS	195
SWW, SWWZ	196
SWC	198
SWD	201
ESCRFTZ, ESCRFTC	202
ESCRFT	204

### 3.3.3 CLT Half-Lap Connections

TTUFS	206
SWW, SWWZ	208
SWC	210
SWD	213
ESCRFTZ	214
ESCRFT	215

### 3.3.4 CLT Butt-Joint Connections

SWD	217, 220
ESCRFTZ	218, 221
ESCRFT	219, 222

### 3.3.5 CLT Spline Connections

TTUFS	223
WSV	225

### 3.1 Solid Timber Fastening

## Solid-Drive™ TTUFS Countersunk WOOD Screw for Timber to Timber

Electro Galvanised  
C1 acc. to EN ISO 12944-2  
SC2 – 50 years acc. to EC5

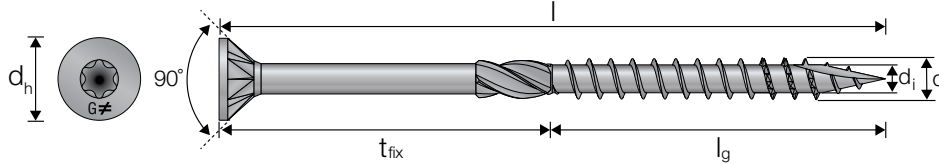

TTUFS – Characteristic Tension and Shear Capacities, Parallel (0°) to the Grain  
Timber to Timber C24

Product Reference	Thread Length $L_g$ [mm]	Max Advised Wood Thickness $t_1$ [mm]	Tension Capacity $R_{ax,k}$ and Shear Capacity $R_{v,0°k}$ Parallel to the Grain Depending on $t_1$ [kN]															
			Wood Thickness $t_1$ [mm]															
			36		45		50		60		63		70		75		80	
TTUFS5.0X80	40	40	1,54	1,94 1,64	1,54	1,94 1,64	-	-	-	-	-	-	-	-	-	-	-	-
TTUFS5.0X90	45	45	1,54	1,94 1,64	1,54	1,94 1,64	1,54	1,94 1,64	-	-	-	-	-	-	-	-	-	-
TTUFS5.0X100	60	40	1,54	1,94 1,64	1,54	1,94 1,64	-	-	-	-	-	-	-	-	-	-	-	-
TTUFS5.0X120	60	60	1,54	1,94 1,64	1,54	1,94 1,64	1,54	1,94 1,64	1,54	1,94 1,64	1,54	1,94 1,64	-	-	-	-	-	-
TTUFS6.0X80	40	40	2,23	2,58 2,09	2,23	2,58 2,06	-	-	-	-	-	-	-	-	-	-	-	-
TTUFS6.0X90	45	45	2,23	2,58 2,09	2,23	2,58 2,15	2,23	2,58 2,15	-	-	-	-	-	-	-	-	-	-
TTUFS6.0X100	60	40	2,23	2,58 2,09	2,23	2,58 2,15	-	-	-	-	-	-	-	-	-	-	-	-
TTUFS6.0X120	70	50	2,23	2,58 2,09	2,23	2,58 2,15	2,23	2,58 2,15	-	-	-	-	-	-	-	-	-	-
TTUFS6.0X140	70	70	2,23	2,58 2,09	2,23	2,58 2,15	2,23	2,58 2,15	2,23	2,58 2,15	2,23	2,58 2,15	2,23	2,58 2,15	2,23	2,58 2,15	-	-
TTUFS6.0X160	70	90	2,23	2,58 2,09	2,23	2,58 2,15	2,23	2,58 2,15	2,23	2,58 2,15	2,23	2,58 2,15	2,23	2,58 2,15	2,23	2,58 2,15	2,23	2,58 2,15
TTUFS6.0X180	70	110	2,23	2,58 2,09	2,23	2,58 2,15	2,23	2,58 2,15	2,23	2,58 2,15	2,23	2,58 2,15	2,23	2,58 2,15	2,23	2,58 2,15	2,23	2,58 2,15

For dimensions and calculation parameters see p. 40.

Tension capacity  $R_{ax,k}$

Characteristic capacities	2,23	2,58	With pre-drill
		2,15	Without pre-drill

Shear capacity  $R_{v,k}$

**Tension**

**Shear Parallel (0°) to the Grain**

For pre-drilling recommendations see page 21.

### 3.1 Solid Timber Fastening

#### TTUFS – Characteristic Tension and Shear Capacities, Perpendicular (90°) to the Grain Timber to Timber C24

Product Reference	Thread Length $L_g$ [mm]	Max Advised Wood Thickness $t_1$ [mm]	Tension Capacity $R_{ax,k}$ and Shear Capacity $R_{v,90^\circ,k}$ Perpendicular to the Grain Depending on $t_1$ [kN]																	
			Wood Thickness $t_1$ [mm]																	
			36		45		50		60		63		70		75		80		100	
TTUFS5.0X80	40	40	1,54	1,94 1,64	1,54	1,94 1,64	-	-	-	-	-	-	-	-	-	-	-	-	-	-
TTUFS5.0X90	45	45	1,54	1,94 1,64	1,54	1,94 1,64	1,54	1,94 1,64	-	-	-	-	-	-	-	-	-	-	-	-
TTUFS5.0X100	60	40	1,54	1,94 1,64	1,54	1,94 1,64	-	-	-	-	-	-	-	-	-	-	-	-	-	-
TTUFS5.0X120	60	60	1,54	1,94 1,64	1,54	1,94 1,64	1,54	1,94 1,64	1,54	1,94 1,64	1,54	1,94 1,64	-	-	-	-	-	-	-	-
TTUFS6.0X80	40	40	2,23	2,58 2,09	2,23	2,58 2,06	-	-	-	-	-	-	-	-	-	-	-	-	-	-
TTUFS6.0X90	45	45	2,23	2,58 2,09	2,23	2,58 2,15	2,23	2,58 2,15	-	-	-	-	-	-	-	-	-	-	-	-
TTUFS6.0X100	60	40	2,23	2,58 2,09	2,23	2,58 2,15	-	-	-	-	-	-	-	-	-	-	-	-	-	-
TTUFS6.0X120	70	50	2,23	2,58 2,09	2,23	2,58 2,15	2,23	2,58 2,15	-	-	-	-	-	-	-	-	-	-	-	-
TTUFS6.0X140	70	70	2,23	2,58 2,09	2,23	2,58 2,15	2,23	2,58 2,15	2,23	2,58 2,15	2,23	2,58 2,15	2,23	2,58 2,15	2,23	2,58 2,15	-	-	-	-
TTUFS6.0X160	70	90	2,23	2,58 2,09	2,23	2,58 2,15	2,23	2,58 2,15	2,23	2,58 2,15	2,23	2,58 2,15	2,23	2,58 2,15	2,23	2,58 2,15	2,23	2,58 2,15	-	-
TTUFS6.0X180	70	110	2,23	2,58 2,09	2,23	2,58 2,15	2,23	2,58 2,15	2,23	2,58 2,15	2,23	2,58 2,15	2,23	2,58 2,15	2,23	2,58 2,15	2,23	2,58 2,15	2,23	2,58 2,15

For dimensions and calculation parameters see p. 40.

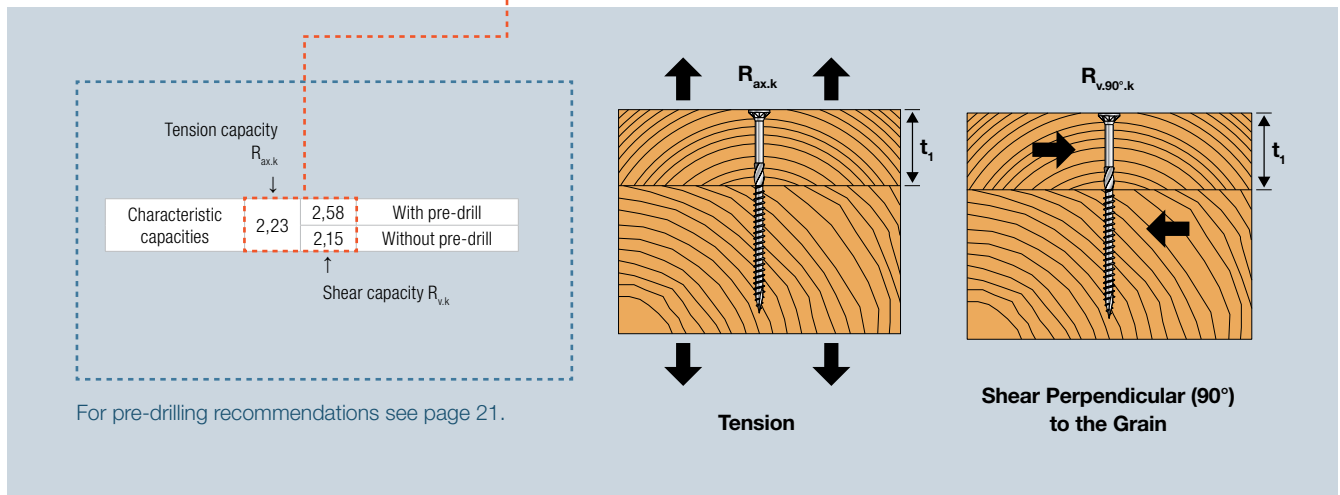

To ensure that the values in this catalog are valid, check that max. 5 mm of the thread is in the first element for partially threaded screws or that max. half the thread +/- 5 mm is in each element for the fully threaded screws.

For additional values in other configurations use Solid Wood – online dimensioning tool. Go to [solidwood.strongtie.eu](http://solidwood.strongtie.eu).

If the screw you are looking for is not shown in this table, it is because the screw cannot fulfil the requirements stated above. In this case, use Solid Wood to determine the capacity of the screw.

### 3.1 Solid Timber Fastening

## Solid-Drive™ TTZNFS Countersunk WOOD Screw for Timber to Timber

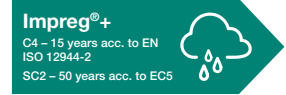

ETA-21/0670

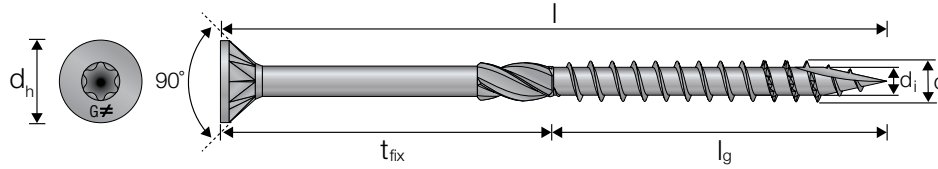

TTZNFS – Characteristic Tension and Shear Capacities, Parallel (0°) to the Grain  
Timber to Timber C24

Product Reference	Thread Length $L_g$ [mm]	Max Advised Wood Thickness $t_1$ [mm]	Tension Capacity $R_{ax,k}$ and Shear Capacity $R_{v,0^\circ,k}$ Parallel to the Grain Depending on $t_1$ [kN]															
			Wood Thickness $t_1$ [mm]															
			36		45		50		60		63		70		75		80	
TTZNFS5.0X80	40	40	1,54	1,94 1,64	1,54	1,94 1,64	-	-	-	-	-	-	-	-	-	-	-	-
TTZNFS5.0X90	45	45	1,54	1,94 1,64	1,54	1,94 1,64	1,54	1,94 1,64	-	-	-	-	-	-	-	-	-	-
TTZNFS5.0X100	60	40	1,54	1,94 1,64	1,54	1,94 1,64	-	-	-	-	-	-	-	-	-	-	-	-
TTZNFS5.0X120	60	60	1,54	1,94 1,64	1,54	1,94 1,64	1,54	1,94 1,64	1,54	1,94 1,64	1,54	1,94 1,64	-	-	-	-	-	-
TTZNFS6.0X80	40	40	2,23	2,58 2,09	2,23	2,58 2,06	-	-	-	-	-	-	-	-	-	-	-	-
TTZNFS6.0X90	45	45	2,23	2,58 2,09	2,23	2,58 2,15	2,23	2,58 2,15	-	-	-	-	-	-	-	-	-	-
TTZNFS6.0X100	60	40	2,23	2,58 2,09	2,23	2,58 2,15	-	-	-	-	-	-	-	-	-	-	-	-
TTZNFS6.0X120	70	50	2,23	2,58 2,09	2,23	2,58 2,15	2,23	2,58 2,15	-	-	-	-	-	-	-	-	-	-
TTZNFS6.0X140	70	70	2,23	2,58 2,09	2,23	2,58 2,15	2,23	2,58 2,15	2,23	2,58 2,15	2,23	2,58 2,15	2,23	2,58 2,15	2,23	2,58 2,15	-	-
TTZNFS6.0X160	70	90	2,23	2,58 2,09	2,23	2,58 2,15	2,23	2,58 2,15	2,23	2,58 2,15	2,23	2,58 2,15	2,23	2,58 2,15	2,23	2,58 2,15	2,23	2,58 2,15
TTZNFS6.0X180	70	110	2,23	2,58 2,09	2,23	2,58 2,15	2,23	2,58 2,15	2,23	2,58 2,15	2,23	2,58 2,15	2,23	2,58 2,15	2,23	2,58 2,15	2,23	2,58 2,15

For dimensions and calculation parameters see p. 40.

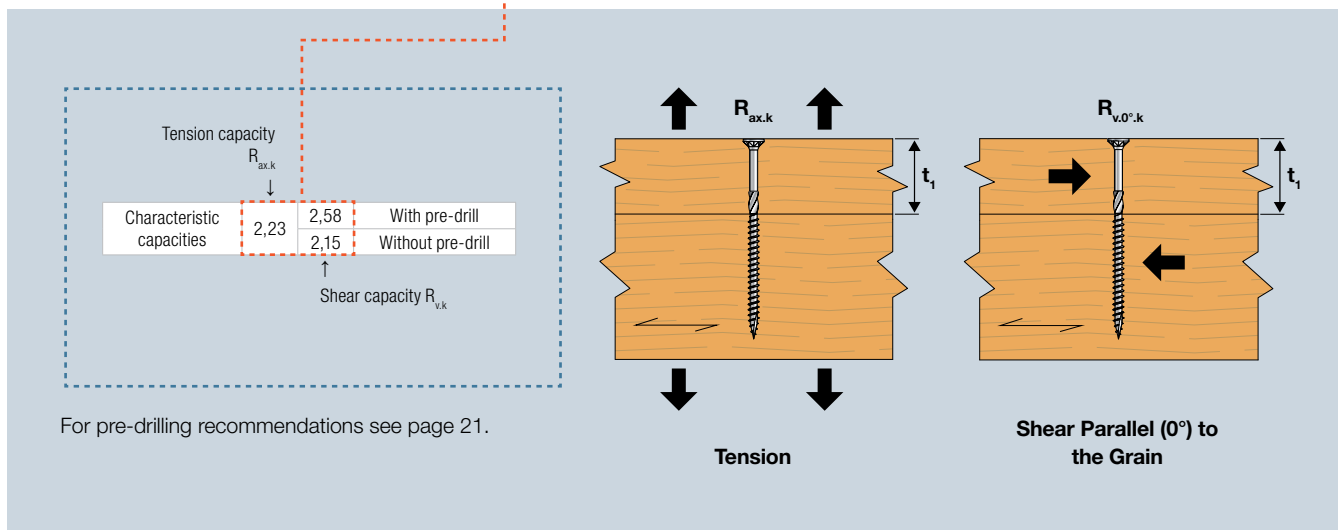

### 3.1 Solid Timber Fastening

#### TTZNFS – Characteristic Tension and Shear Capacities, Perpendicular (90°) to the Grain Timber to Timber C24

Product Reference	Thread Length $L_g$ [mm]	Max Advised Wood Thickness $t_1$ [mm]	Tension Capacity $R_{ax,k}$ and Shear Capacity $R_{v,90^\circ,k}$ Perpendicular to the Grain Depending on $t_1$ [kN]																	
			Wood Thickness $t_1$ [mm]																	
			36		45		50		60		63		70		75		80		100	
TTZNFS5.0X80	40	40	1,54	1,94 1,64	1,54	1,94 1,64	-	-	-	-	-	-	-	-	-	-	-	-	-	
TTZNFS5.0X90	45	45	1,54	1,94 1,64	1,54	1,94 1,64	1,54	1,94 1,64	-	-	-	-	-	-	-	-	-	-	-	
TTZNFS5.0X100	60	40	1,54	1,94 1,64	1,54	1,94 1,64	-	-	-	-	-	-	-	-	-	-	-	-	-	
TTZNFS5.0X120	60	60	1,54	1,94 1,64	1,54	1,94 1,64	1,54	1,94 1,64	1,54	1,94 1,64	1,54	1,94 1,64	-	-	-	-	-	-	-	
TTZNFS6.0X80	40	40	2,23	2,58 2,09	2,23	2,58 2,06	-	-	-	-	-	-	-	-	-	-	-	-	-	
TTZNFS6.0X90	45	45	2,23	2,58 2,09	2,23	2,58 2,15	2,23	2,58 2,15	-	-	-	-	-	-	-	-	-	-	-	
TTZNFS6.0X100	60	40	2,23	2,58 2,09	2,23	2,58 2,15	-	-	-	-	-	-	-	-	-	-	-	-	-	
TTZNFS6.0X120	70	50	2,23	2,58 2,09	2,23	2,58 2,15	2,23	2,58 2,15	-	-	-	-	-	-	-	-	-	-	-	
TTZNFS6.0X140	70	70	2,23	2,58 2,09	2,23	2,58 2,15	2,23	2,58 2,15	2,23	2,58 2,15	2,23	2,58 2,15	2,23	2,58 2,15	2,23	2,58 2,15	-	-	-	
TTZNFS6.0X160	70	90	2,23	2,58 2,09	2,23	2,58 2,15	2,23	2,58 2,15	2,23	2,58 2,15	2,23	2,58 2,15	2,23	2,58 2,15	2,23	2,58 2,15	2,23	2,58 2,15	-	
TTZNFS6.0X180	70	110	2,23	2,58 2,09	2,23	2,58 2,15	2,23	2,58 2,15	2,23	2,58 2,15	2,23	2,58 2,15	2,23	2,58 2,15	2,23	2,58 2,15	2,23	2,58 2,15	2,23	2,58 2,15

For dimensions and calculation parameters see p. 40.

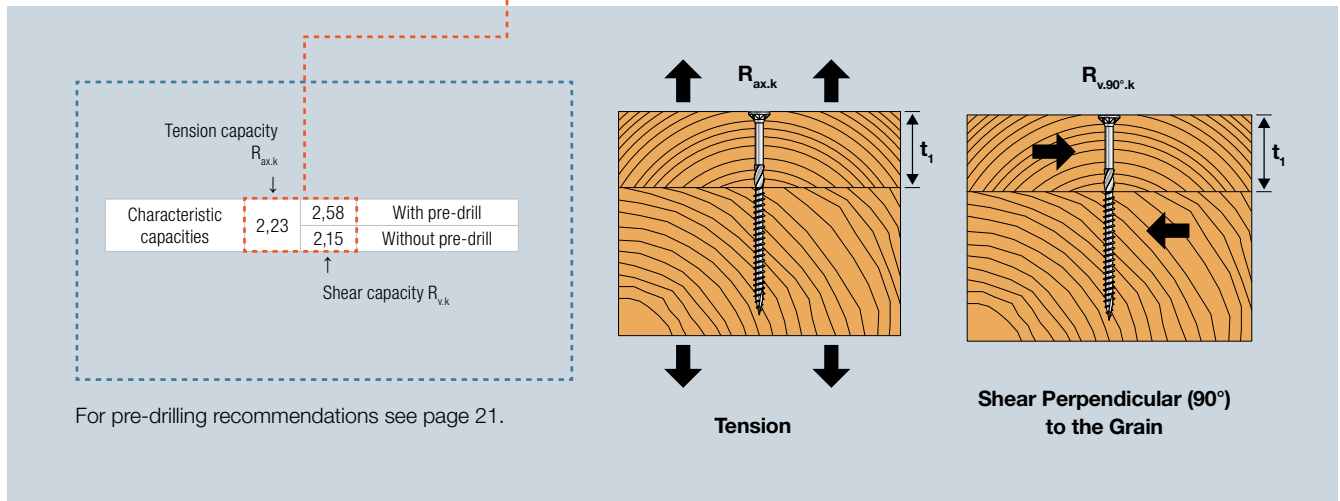

To ensure that the values in this catalog are valid, check that max. 5 mm of the thread is in the first element for partially threaded screws or that max. half the thread +/- 5 mm is in each element for the fully threaded screws.

For additional values in other configurations use Solid Wood – online dimensioning tool. Go to [solidwood.strongtie.eu](http://solidwood.strongtie.eu).

If the screw you are looking for is not shown in this table, it is because the screw cannot fulfil the requirements stated above. In this case, use Solid Wood to determine the capacity of the screw.

### 3.1 Solid Timber Fastening

## Solid-Drive™ TTSFS Countersunk WOOD Screw for Timber to Timber



ETA-21/0670

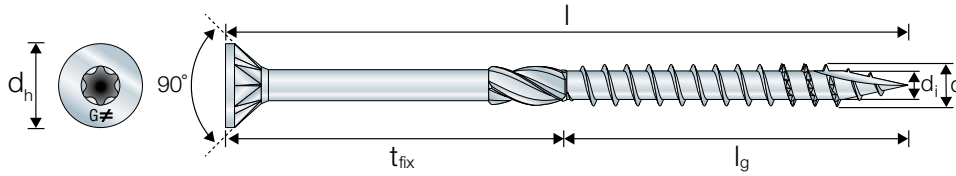

TTSFS – Characteristic Tension and Shear Capacities, Parallel (0°) to the Grain  
Timber to Timber C24

Product Reference	Thread Length $L_g$ [mm]	Max Advised Wood Thickness $t_1$ [mm]	Tension Capacity $R_{ax,k}$ and Shear Capacity $R_{v,0°k}$ Parallel to the Grain Depending on $t_1$ [kN]															
			Wood Thickness $t_1$ [mm]															
			36		45		50		60		63		70		75		80	
TTSFS5.0X70	35	35	1,44	1,66 1,41	-	-	-	-	-	-	-	-	-	-	-	-	-	-
TTSFS5.0X80	40	40	1,44	1,66 1,41	1,44	1,66 1,41	-	-	-	-	-	-	-	-	-	-	-	-
TTSFS5.0X90	45	45	1,44	1,66 1,41	1,44	1,66 1,41	1,44	1,66 1,41	-	-	-	-	-	-	-	-	-	-
TTSFS5.0X100	55	45	1,44	1,66 1,41	1,44	1,66 1,41	1,44	1,66 1,41	-	-	-	-	-	-	-	-	-	-
TTSFS5.0X120	60	60	1,44	1,66 1,41	1,44	1,66 1,41	1,44	1,66 1,41	1,44	1,66 1,41	1,44	1,66 1,41	-	-	-	-	-	-
TTSFS6.0X70	35	35	2,18	2,46 1,99	-	-	-	-	-	-	-	-	-	-	-	-	-	-
TTSFS6.0X80	40	40	2,18	2,46 2,05	2,18	2,46 2,02	-	-	-	-	-	-	-	-	-	-	-	-
TTSFS6.0X90	45	45	2,18	2,46 2,05	2,18	2,46 2,06	2,18	2,46 2,06	-	-	-	-	-	-	-	-	-	-
TTSFS6.0X100	55	45	2,18	2,46 2,05	2,18	2,46 2,06	2,18	2,46 2,06	-	-	-	-	-	-	-	-	-	-
TTSFS6.0X120	60	60	2,18	2,46 2,05	2,18	2,46 2,06	2,18	2,46 2,06	2,18	2,46 2,06	2,18	2,46 2,06	-	-	-	-	-	-
TTSFS6.0X140	65	75	2,18	2,46 2,05	2,18	2,46 2,06	2,18	2,46 2,06	2,18	2,46 2,06	2,18	2,46 2,06	2,18	2,46 2,06	2,18	2,46 2,06	2,18	2,46 2,06

For dimensions and calculation parameters see p. 40.

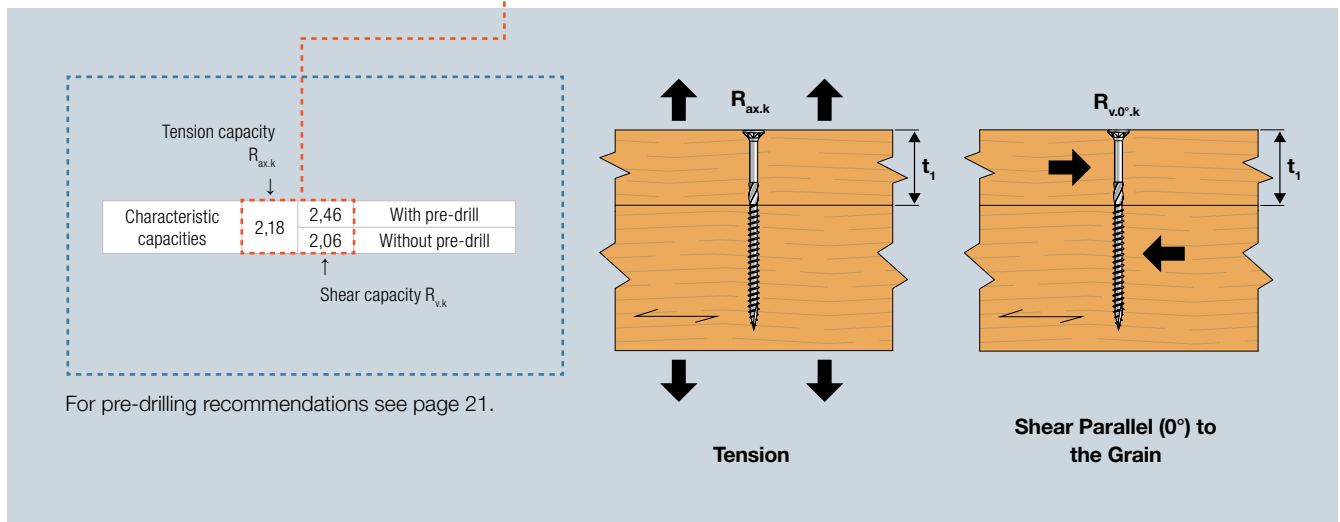

Timber to Timber Fastening

C-F-EU-TG-2023-2 (2<sup>nd</sup> Edition) © 2023 SIMPSON STRONG-TIE COMPANY INC.



### 3.1 Solid Timber Fastening

#### TTSFS – Characteristic Tension and Shear Capacities, Perpendicular (90°) to the Grain Timber to Timber C24

Product Reference	Thread Length $L_g$ [mm]	Max Advised Wood Thickness $t_1$ [mm]	Tension Capacity $R_{ax,k}$ and Shear Capacity $R_{v,90°k}$ Perpendicular to the Grain Depending on $t_1$ [kN]																	
			Wood Thickness $t_1$ [mm]																	
			36	45	50	60	63	70	75	80	100	36	45	50	60	63	70	75	80	100
TTSFS5.0X70	35	35	1,44	1,66 1,41	-	-	-	-	-	-	-	-	-	-	-	-	-	-	-	
TTSFS5.0X80	40	40	1,44	1,66 1,41	1,44	1,66 1,41	-	-	-	-	-	-	-	-	-	-	-	-	-	
TTSFS5.0X90	45	45	1,44	1,66 1,41	1,44	1,66 1,41	1,44	1,66 1,41	-	-	-	-	-	-	-	-	-	-	-	
TTSFS5.0X100	55	45	1,44	1,66 1,41	1,44	1,66 1,41	1,44	1,66 1,41	-	-	-	-	-	-	-	-	-	-	-	
TTSFS5.0X120	60	60	1,44	1,66 1,41	1,44	1,66 1,41	1,44	1,66 1,41	1,44	1,66 1,41	1,44	1,66 1,41	-	-	-	-	-	-	-	
TTSFS6.0X70	35	35	2,18	2,46 1,99	-	-	-	-	-	-	-	-	-	-	-	-	-	-	-	
TTSFS6.0X80	40	40	2,18	2,46 2,05	2,18	2,46 2,02	-	-	-	-	-	-	-	-	-	-	-	-	-	
TTSFS6.0X90	45	45	2,18	2,46 2,05	2,18	2,46 2,06	2,18	2,46 2,06	-	-	-	-	-	-	-	-	-	-	-	
TTSFS6.0X100	55	45	2,18	2,46 2,05	2,18	2,46 2,06	2,18	2,46 2,06	-	-	-	-	-	-	-	-	-	-	-	
TTSFS6.0X120	60	60	2,18	2,46 2,05	2,18	2,46 2,06	2,18	2,46 2,06	2,18	2,46 2,06	2,18	2,46 2,06	-	-	-	-	-	-	-	
TTSFS6.0X140	65	75	2,18	2,46 2,05	2,18	2,46 2,06	2,18	2,46 2,06	2,18	2,46 2,06	2,18	2,46 2,06	2,18	2,46 2,06	2,18	2,46 2,06	2,18	2,46 2,06	-	-

For dimensions and calculation parameters see p. 40.

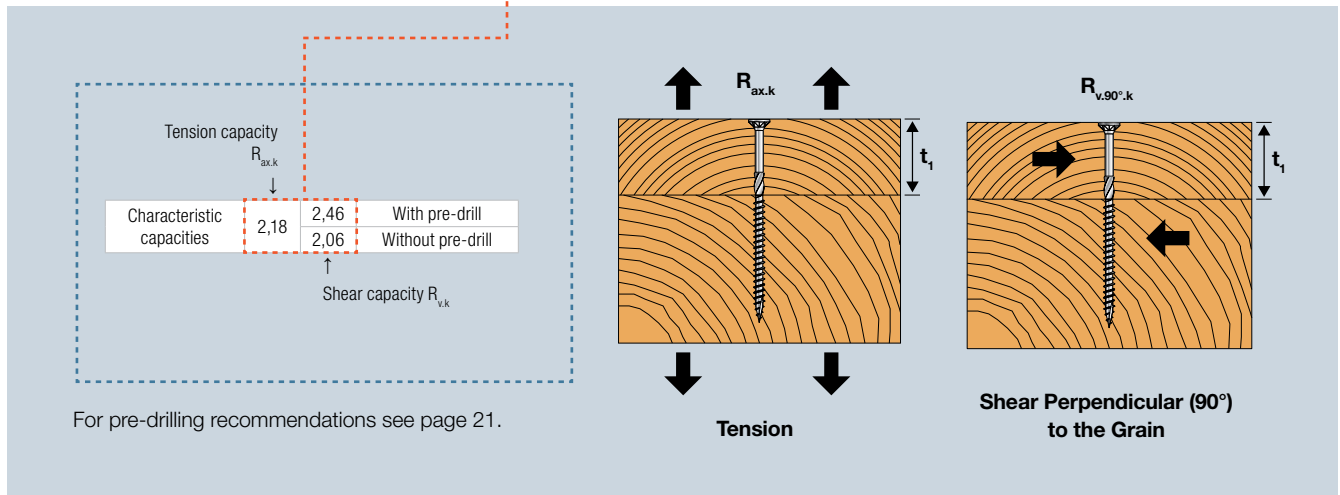

To ensure that the values in this catalog are valid, check that max. 5 mm of the thread is in the first element for partially threaded screws or that max. half the thread +/- 5 mm is in each element for the fully threaded screws.

For additional values in other configurations use Solid Wood – online dimensioning tool. Go to [solidwood.strongtie.eu](http://solidwood.strongtie.eu).

If the screw you are looking for is not shown in this table, it is because the screw cannot fulfil the requirements stated above. In this case, use Solid Wood to determine the capacity of the screw.

### 3.1 Solid Timber Fastening

#### TTUFS/TTZNFS/TTSFS – Minimum Distances for Screws in Shear or Combined Loads<sup>1)</sup> Timber to Timber C24

Outer Thread Diameter d [mm]	Pre-drill	Angle Between Load Direction and Grain = 0°						Angle Between Load Direction and Grain = 90°					
		a <sub>1</sub>	a <sub>2</sub>	a <sub>3,c</sub>	a <sub>3,t</sub>	a <sub>4,c</sub>	a <sub>4,t</sub>	a <sub>1</sub>	a <sub>2</sub>	a <sub>3,c</sub>	a <sub>3,t</sub>	a <sub>4,c</sub>	a <sub>4,t</sub>
4.5	With pre-drill	23	14	32	54	14	14	18	18	32	23	14	32
	Without pre-drill	45	23	45	68	23	23	23	23	45	45	23	32
5.0	With pre-drill	25	15	35	60	15	15	20	20	35	25	15	35
	Without pre-drill	60	25	50	75	25	25	25	25	50	50	25	50
6.0	With pre-drill	30	18	42	72	18	18	24	24	42	30	18	42
	Without pre-drill	72	30	60	90	30	30	30	30	60	60	30	60

<sup>1)</sup> Minimum distances comply with EN 1995-1-1 (Eurocode 5) and ETA21/0670

<sup>2)</sup> Values given in the table is based on the  $\rho_k \leq 350 \text{ kg/m}^3$

<sup>3)</sup> Minimum distances from the unloaded edge perpendicular to the grain may be reduced to  $a_{4,c} = 3 \times d$  if the spacing parallel to the grain ( $a_1$ ) and the end distance ( $a_{3,t}$ ) is at least  $25 \times d$ .

#### TTUFS/TTZNFS/TTSFS – Minimum Distances for Axially Loaded Screws Timber to Timber C24

Outer Thread Diameter d [mm]	a <sub>1</sub>	a <sub>2</sub>	a <sub>3,c</sub>	a <sub>4,c</sub>
4.5	32	23	45	18
5.0	35	25	50	20
6.0	42	30	60	24

\*Valid if the applied centre distances comply with  $a_1, a_2 \geq 25d^2$ .  
Calculation according to EN1995-1-1:2004+A2:2014.

For axially loaded screws installed perpendicular to the surface  $a_{3,t}$  and  $a_{4,t}$  are not relevant. For more info see General Introduction page 24.

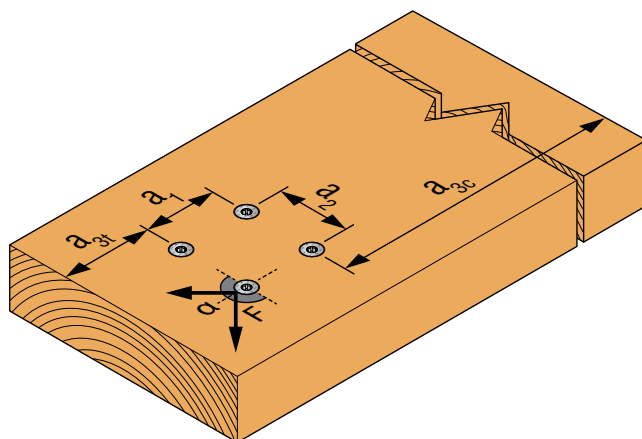

Illustration above shows angle between load direction and grain = 0°

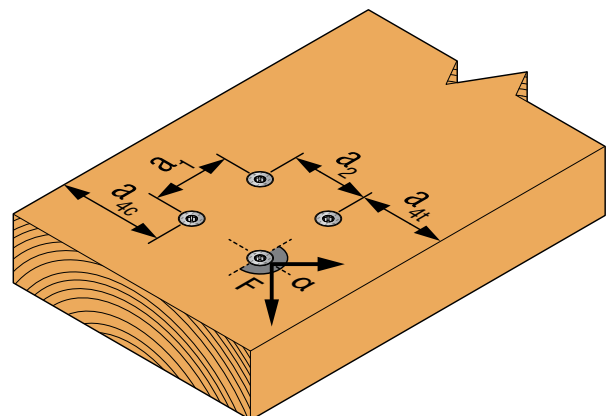

Illustration above shows angle between load direction and grain = 90°

See explanation of  $\alpha$  in General Introduction page 23.



#### Solid Wood Fastener Dimensioning Software

In just four simple steps, Solid Wood guides you through the calculation and selection of fastening solutions suitable for the specific wood structure at hand, all according to Eurocode 5 and our ETA.

Try Solid Wood today. Go to [solidwood.strongtie.eu](http://solidwood.strongtie.eu)

### 3.1 Solid Timber Fastening

## Solid-Drive™ SWW Structural Washer-Head WOOD Screw for Timber to Timber

**Yellow Zinc Plated**  
C2 acc. to EN ISO 12944-2  
SC2 – 50 years acc. to EC5

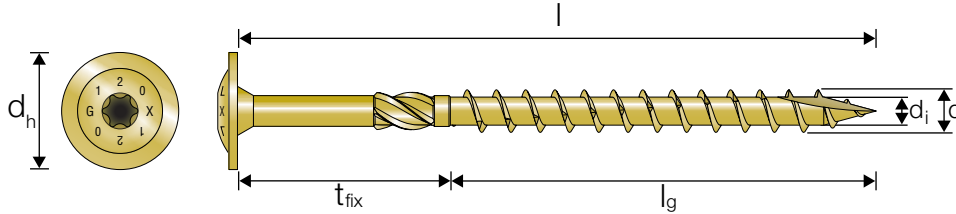

SWW – Characteristic Tension and Shear Capacities, Parallel (0°) to the Grain  
Timber to Timber C24

Product Reference	Thread Length $L_g$ [mm]	Max Advised Wood Thickness $t_1$ [mm]	Tension Capacity $R_{ax,k}$ and Shear Capacity $R_{v,0^\circ,k}$ Parallel to the Grain Depending on $t_1$ [kN]															
			Wood Thickness $t_1$ [mm]															
			36		45		50		60		63		70		75		80	
SWW6.0X100	50	50	3,16	2,91 2,35	3,16	2,91 2,46	3,16	2,91 2,46	-	-	-	-	-	-	-	-	-	-
SWW6.0X120	50	70	3,16	2,91 2,35	3,16	2,91 2,46	3,16	2,91 2,46	3,16	2,91 2,46	3,16	2,91 2,46	3,16	2,91 2,46	3,16	2,91 2,46	-	-
SWW6.0X140	70	70	3,16	2,91 2,35	3,16	2,91 2,46	3,16	2,91 2,46	3,16	2,91 2,46	3,16	2,91 2,46	3,16	2,91 2,46	3,16	2,91 2,46	-	-
SWW6.0X160	70	90	3,16	2,91 2,35	3,16	2,91 2,46	3,16	2,91 2,46	3,16	2,91 2,46	3,16	2,91 2,46	3,16	2,91 2,46	3,16	2,91 2,46	3,16	2,91 2,46
SWW6.0X180	70	110	3,16	2,91 2,35	3,16	2,91 2,46	3,16	2,91 2,46	3,16	2,91 2,46	3,16	2,91 2,46	3,16	2,91 2,46	3,16	2,91 2,46	3,16	2,91 2,46
SWW6.0X200	70	130	3,16	2,91 2,35	3,16	2,91 2,46	3,16	2,91 2,46	3,16	2,91 2,46	3,16	2,91 2,46	3,16	2,91 2,46	3,16	2,91 2,46	3,16	2,91 2,46
SWW6.0X220	70	150	3,16	2,91 2,35	3,16	2,91 2,46	3,16	2,91 2,46	3,16	2,91 2,46	3,16	2,91 2,46	3,16	2,91 2,46	3,16	2,91 2,46	3,16	2,91 2,46
SWW6.0X240	70	170	3,16	2,91 2,35	3,16	2,91 2,46	3,16	2,91 2,46	3,16	2,91 2,46	3,16	2,91 2,46	3,16	2,91 2,46	3,16	2,91 2,46	3,16	2,91 2,46
SWW6.0X260	70	190	3,16	2,91 2,35	3,16	2,91 2,46	3,16	2,91 2,46	3,16	2,91 2,46	3,16	2,91 2,46	3,16	2,91 2,46	3,16	2,91 2,46	3,16	2,91 2,46
SWW6.0X280	70	210	3,16	2,91 2,35	3,16	2,91 2,46	3,16	2,91 2,46	3,16	2,91 2,46	3,16	2,91 2,46	3,16	2,91 2,46	3,16	2,91 2,46	3,16	2,91 2,46
SWW6.0X300	70	230	3,16	2,91 2,35	3,16	2,91 2,46	3,16	2,91 2,46	3,16	2,91 2,46	3,16	2,91 2,46	3,16	2,91 2,46	3,16	2,91 2,46	3,16	2,91 2,46

Table continues on next page.

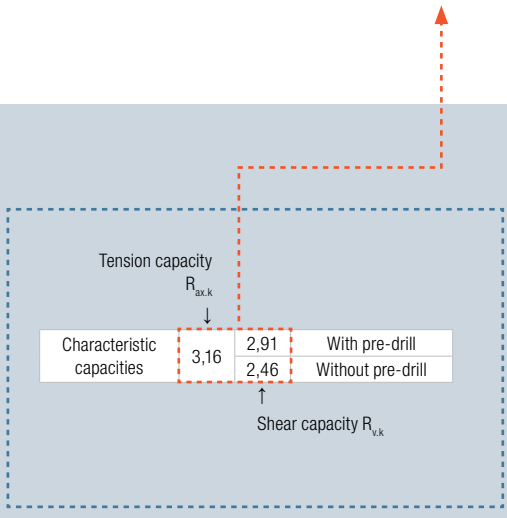

For pre-drilling recommendations see page 21.

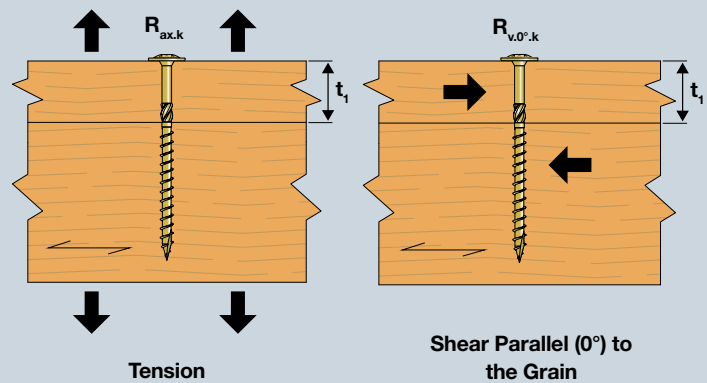

Timber to Timber Fastening

C-F-EU-TG-2023-2 (2<sup>nd</sup> Edition) © 2023 SIMPSON STRONG-TIE COMPANY, INC.

### 3.1 Solid Timber Fastening

SWW – Characteristic Tension and Shear Capacities, Parallel (0°) to the Grain  
Timber to Timber C24 (continued)

Product Reference	Thread Length $L_g$ [mm]	Max Advised Wood Thickness $t_1$ [mm]	Tension Capacity $R_{ax,k}$ and Shear Capacity $R_{v,0^\circ,k}$ Parallel to the Grain Depending on $t_1$ [kN]																	
			Wood Thickness $t_1$ [mm]																	
			36		45		50		60		63		70		75		80		100	
SWW8.0X100	50	50	5,04	4,63 3,49	5,04	5,06 3,76	5,04	5,06 3,81	-	-	-	-	-	-	-	-	-	-	-	
SWW8.0X120	80	40	5,08	4,64 3,50	5,08	5,07 3,77	-	-	-	-	-	-	-	-	-	-	-	-	-	
SWW8.0X140	80	60	5,08	4,64 3,50	5,08	5,07 3,77	5,08	5,07 3,94	5,08	5,07 4,17	5,08	5,07 4,17	-	-	-	-	-	-	-	
SWW8.0X160	80	80	5,08	4,64 3,50	5,08	5,07 3,77	5,08	5,07 3,94	5,08	5,07 4,17	5,08	5,07 4,17	5,08	5,07 4,17	5,08	5,07 4,17	5,08	5,07 4,17	-	-
SWW8.0X180	80	100	5,08	4,64 3,50	5,08	5,07 3,77	5,08	5,07 3,94	5,08	5,07 4,17	5,08	5,07 4,17	5,08	5,07 4,17	5,08	5,07 4,17	5,08	5,07 4,17	5,08	5,07 4,17
SWW8.0X200	80	120	5,08	4,64 3,50	5,08	5,07 3,77	5,08	5,07 3,94	5,08	5,07 4,17	5,08	5,07 4,17	5,08	5,07 4,17	5,08	5,07 4,17	5,08	5,07 4,17	5,08	5,07 4,17
SWW8.0X220	80	140	5,08	4,64 3,50	5,08	5,07 3,77	5,08	5,07 3,94	5,08	5,07 4,17	5,08	5,07 4,17	5,08	5,07 4,17	5,08	5,07 4,17	5,08	5,07 4,17	5,08	5,07 4,17
SWW8.0X240	80	160	5,08	4,64 3,50	5,08	5,07 3,77	5,08	5,07 3,94	5,08	5,07 4,17	5,08	5,07 4,17	5,08	5,07 4,17	5,08	5,07 4,17	5,08	5,07 4,17	5,08	5,07 4,17
SWW8.0X260	80	180	5,08	4,64 3,50	5,08	5,07 3,77	5,08	5,07 3,94	5,08	5,07 4,17	5,08	5,07 4,17	5,08	5,07 4,17	5,08	5,07 4,17	5,08	5,07 4,17	5,08	5,07 4,17
SWW8.0X280	80	200	5,08	4,64 3,50	5,08	5,07 3,77	5,08	5,07 3,94	5,08	5,07 4,17	5,08	5,07 4,17	5,08	5,07 4,17	5,08	5,07 4,17	5,08	5,07 4,17	5,08	5,07 4,17
SWW8.0X300	80	220	5,08	4,64 3,50	5,08	5,07 3,77	5,08	5,07 3,94	5,08	5,07 4,17	5,08	5,07 4,17	5,08	5,07 4,17	5,08	5,07 4,17	5,08	5,07 4,17	5,08	5,07 4,17
SWW8.0X320	80	240	5,08	4,64 3,50	5,08	5,07 3,77	5,08	5,07 3,94	5,08	5,07 4,17	5,08	5,07 4,17	5,08	5,07 4,17	5,08	5,07 4,17	5,08	5,07 4,17	5,08	5,07 4,17
SWW8.0X340	80	260	5,08	4,64 3,50	5,08	5,07 3,77	5,08	5,07 3,94	5,08	5,07 4,17	5,08	5,07 4,17	5,08	5,07 4,17	5,08	5,07 4,17	5,08	5,07 4,17	5,08	5,07 4,17
SWW8.0X360	80	280	5,08	4,64 3,50	5,08	5,07 3,77	5,08	5,07 3,94	5,08	5,07 4,17	5,08	5,07 4,17	5,08	5,07 4,17	5,08	5,07 4,17	5,08	5,07 4,17	5,08	5,07 4,17
SWW8.0X380	80	300	5,08	4,64 3,50	5,08	5,07 3,77	5,08	5,07 3,94	5,08	5,07 4,17	5,08	5,07 4,17	5,08	5,07 4,17	5,08	5,07 4,17	5,08	5,07 4,17	5,08	5,07 4,17
SWW8.0X400	80	320	5,08	4,64 3,50	5,08	5,07 3,77	5,08	5,07 3,94	5,08	5,07 4,17	5,08	5,07 4,17	5,08	5,07 4,17	5,08	5,07 4,17	5,08	5,07 4,17	5,08	5,07 4,17

Table continues on next page.

Tension capacity $R_{ax,k}$		
Characteristic capacities	5,08	5,07
		3,77
		↑
Shear capacity $R_{v,k}$		
		With pre-drill
		Without pre-drill

For pre-drilling recommendations see page 21.

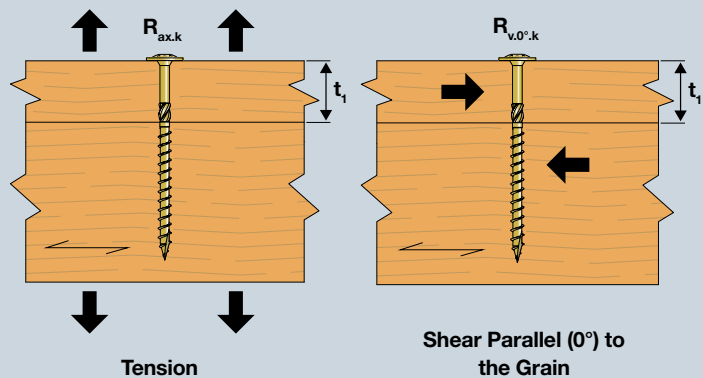

### 3.1 Solid Timber Fastening

#### SWW – Characteristic Tension and Shear Capacities, Parallel (0°) to the Grain Timber to Timber C24 (continued)

Product Reference	Thread Length $L_g$ [mm]	Max Advised Wood Thickness $t_f$ [mm]	Tension Capacity $R_{ax,k}$ and Shear Capacity $R_{v,0^\circ,k}$ Parallel to the Grain Depending on $t_f$ [kN]																	
			Wood Thickness $t_f$ [mm]																	
			36		45		50		60		63		70		75		80		100	
SWW10.0X100	50	50	-	-	6,10	6,56	6,10	6,87	-	-	-	-	-	-	-	-	-	-	-	
SWW10.0X120	50	70	-	-	6,10	6,56	6,10	6,92	6,10	6,99	6,10	6,99	6,10	6,92	5,49	6,56	-	-	-	
SWW10.0X140	80	60	-	-	6,38	6,62	6,38	6,99	6,38	7,06	6,38	7,06	-	-	-	-	-	-	-	
SWW10.0X160	80	80	-	-	6,38	6,62	6,38	6,99	6,38	7,06	6,38	7,06	6,38	7,06	6,38	7,06	6,38	7,06	-	
SWW10.0X180	80	100	-	-	6,38	6,62	6,38	6,99	6,38	7,06	6,38	7,06	6,38	7,06	6,38	7,06	6,38	7,06	6,38	
SWW10.0X200	80	120	-	-	6,38	6,62	6,38	6,99	6,38	7,06	6,38	7,06	6,38	7,06	6,38	7,06	6,38	7,06	6,38	
SWW10.0X220	80	140	-	-	6,38	6,62	6,38	6,99	6,38	7,06	6,38	7,06	6,38	7,06	6,38	7,06	6,38	7,06	6,38	
SWW10.0X240	80	160	-	-	6,38	6,62	6,38	6,99	6,38	7,06	6,38	7,06	6,38	7,06	6,38	7,06	6,38	7,06	6,38	
SWW10.0X260	80	180	-	-	6,38	6,62	6,38	6,99	6,38	7,06	6,38	7,06	6,38	7,06	6,38	7,06	6,38	7,06	6,38	
SWW10.0X280	80	200	-	-	6,38	6,62	6,38	6,99	6,38	7,06	6,38	7,06	6,38	7,06	6,38	7,06	6,38	7,06	6,38	
SWW10.0X300	80	220	-	-	6,38	6,62	6,38	6,99	6,38	7,06	6,38	7,06	6,38	7,06	6,38	7,06	6,38	7,06	6,38	
SWW10.0X320	80	240	-	-	6,38	6,62	6,38	6,99	6,38	7,06	6,38	7,06	6,38	7,06	6,38	7,06	6,38	7,06	6,38	
SWW10.0X340	80	260	-	-	6,38	6,62	6,38	6,99	6,38	7,06	6,38	7,06	6,38	7,06	6,38	7,06	6,38	7,06	6,38	
SWW10.0X360	80	280	-	-	6,38	6,62	6,38	6,99	6,38	7,06	6,38	7,06	6,38	7,06	6,38	7,06	6,38	7,06	6,38	
SWW10.0X380	80	300	-	-	6,38	6,62	6,38	6,99	6,38	7,06	6,38	7,06	6,38	7,06	6,38	7,06	6,38	7,06	6,38	
SWW10.0X400	80	320	-	-	6,38	6,62	6,38	6,99	6,38	7,06	6,38	7,06	6,38	7,06	6,38	7,06	6,38	7,06	6,38	

For dimensions and calculation parameters see p. 44.

Tension capacity $R_{ax,k}$		
Characteristic capacities	6,38	6,62
		4,78
		↑
		Shear capacity $R_{v,k}$

With pre-drill  
Without pre-drill

For pre-drilling recommendations see page 21.

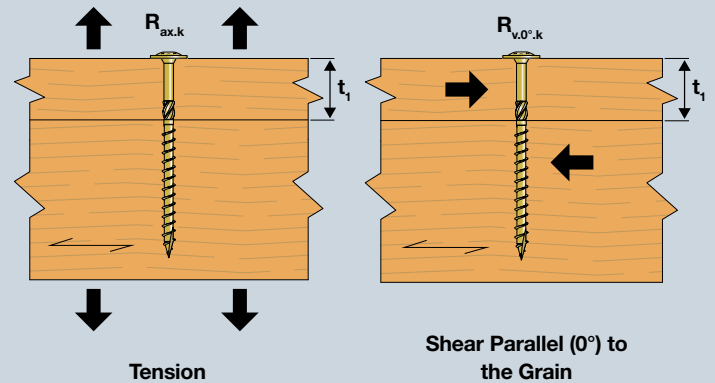

To ensure that the values in this catalog are valid, check that max. 5 mm of the thread is in the first element for partially threaded screws or that max. half the thread +/- 5 mm is in each element for the fully threaded screws.

For additional values in other configurations use Solid Wood – online dimensioning tool. Go to [solidwood.strongtie.eu](http://solidwood.strongtie.eu).

If the screw you are looking for is not shown in this table, it is because the screw cannot fulfil the requirements stated above. In this case, use Solid Wood to determine the capacity of the screw.

C-F-EU-TG-2023-2 (2<sup>nd</sup> Edition) © 2023 SIMPSON STRONG-TIE COMPANY INC.

Timber to Timber Fastening

### 3.1 Solid Timber Fastening

#### SWW – Characteristic Tension and Shear Capacities, Perpendicular (90°) to the Grain Timber to Timber C24

Timber to Timber Fastening

Product Reference	Thread Length $L_g$ [mm]	Max Advised Wood Thickness $t_1$ [mm]	Tension and Shear Capacity $R_{v,90^\circ,k}$ Perpendicular to the Grain Depending on $t_1$ [kN]																	
			Wood Thickness $t_1$ [mm]																	
			36		45		50		60		63		70		75		80		100	
SWW6.0X100	50	50	3,16	2,91 2,35	3,16	2,91 2,46	3,16	2,91 2,46	-	-	-	-	-	-	-	-	-	-	-	
SWW6.0X120	50	70	3,16	2,91 2,35	3,16	2,91 2,46	3,16	2,91 2,46	3,16	2,91 2,46	3,16	2,91 2,46	3,16	2,91 2,46	3,16	2,91 2,46	-	-	-	-
SWW6.0X140	70	70	3,16	2,91 2,35	3,16	2,91 2,46	3,16	2,91 2,46	3,16	2,91 2,46	3,16	2,91 2,46	3,16	2,91 2,46	3,16	2,91 2,46	-	-	-	-
SWW6.0X160	70	90	3,16	2,91 2,35	3,16	2,91 2,46	3,16	2,91 2,46	3,16	2,91 2,46	3,16	2,91 2,46	3,16	2,91 2,46	3,16	2,91 2,46	3,16	2,91 2,46	-	-
SWW6.0X180	70	110	3,16	2,91 2,35	3,16	2,91 2,46	3,16	2,91 2,46	3,16	2,91 2,46	3,16	2,91 2,46	3,16	2,91 2,46	3,16	2,91 2,46	3,16	2,91 2,46	3,16	2,91 2,46
SWW6.0X200	70	130	3,16	2,91 2,35	3,16	2,91 2,46	3,16	2,91 2,46	3,16	2,91 2,46	3,16	2,91 2,46	3,16	2,91 2,46	3,16	2,91 2,46	3,16	2,91 2,46	3,16	2,91 2,46
SWW6.0X220	70	150	3,16	2,91 2,35	3,16	2,91 2,46	3,16	2,91 2,46	3,16	2,91 2,46	3,16	2,91 2,46	3,16	2,91 2,46	3,16	2,91 2,46	3,16	2,91 2,46	3,16	2,91 2,46
SWW6.0X240	70	170	3,16	2,91 2,35	3,16	2,91 2,46	3,16	2,91 2,46	3,16	2,91 2,46	3,16	2,91 2,46	3,16	2,91 2,46	3,16	2,91 2,46	3,16	2,91 2,46	3,16	2,91 2,46
SWW6.0X260	70	190	3,16	2,91 2,35	3,16	2,91 2,46	3,16	2,91 2,46	3,16	2,91 2,46	3,16	2,91 2,46	3,16	2,91 2,46	3,16	2,91 2,46	3,16	2,91 2,46	3,16	2,91 2,46
SWW6.0X280	70	210	3,16	2,91 2,35	3,16	2,91 2,46	3,16	2,91 2,46	3,16	2,91 2,46	3,16	2,91 2,46	3,16	2,91 2,46	3,16	2,91 2,46	3,16	2,91 2,46	3,16	2,91 2,46
SWW6.0X300	70	230	3,16	2,91 2,35	3,16	2,91 2,46	3,16	2,91 2,46	3,16	2,91 2,46	3,16	2,91 2,46	3,16	2,91 2,46	3,16	2,91 2,46	3,16	2,91 2,46	3,16	2,91 2,46
SWW8.0X100	50	50	5,04	4,63 3,49	5,04	5,06 3,76	5,04	5,06 3,81	-	-	-	-	-	-	-	-	-	-	-	-
SWW8.0X120	80	40	5,08	4,64 3,50	5,08	5,07 3,77	-	-	-	-	-	-	-	-	-	-	-	-	-	-
SWW8.0X140	80	60	5,08	4,64 3,50	5,08	5,07 3,77	5,08	5,07 3,94	5,08	5,07 4,17	5,08	5,07 4,17	-	-	-	-	-	-	-	-
SWW8.0X160	80	80	5,08	4,64 3,50	5,08	5,07 3,77	5,08	5,07 3,94	5,08	5,07 4,17	5,08	5,07 4,17	5,08	5,07 4,17	5,08	5,07 4,17	5,08	5,07 4,17	-	-
SWW8.0X180	80	100	5,08	4,64 3,50	5,08	5,07 3,77	5,08	5,07 3,94	5,08	5,07 4,17	5,08	5,07 4,17	5,08	5,07 4,17	5,08	5,07 4,17	5,08	5,07 4,17	5,08	5,07 4,17
SWW8.0X200	80	120	5,08	4,64 3,50	5,08	5,07 3,77	5,08	5,07 3,94	5,08	5,07 4,17	5,08	5,07 4,17	5,08	5,07 4,17	5,08	5,07 4,17	5,08	5,07 4,17	5,08	5,07 4,17
SWW8.0X220	80	140	5,08	4,64 3,50	5,08	5,07 3,77	5,08	5,07 3,94	5,08	5,07 4,17	5,08	5,07 4,17	5,08	5,07 4,17	5,08	5,07 4,17	5,08	5,07 4,17	5,08	5,07 4,17
SWW8.0X240	80	160	5,08	4,64 3,50	5,08	5,07 3,77	5,08	5,07 3,94	5,08	5,07 4,17	5,08	5,07 4,17	5,08	5,07 4,17	5,08	5,07 4,17	5,08	5,07 4,17	5,08	5,07 4,17
SWW8.0X260	80	180	5,08	4,64 3,50	5,08	5,07 3,77	5,08	5,07 3,94	5,08	5,07 4,17	5,08	5,07 4,17	5,08	5,07 4,17	5,08	5,07 4,17	5,08	5,07 4,17	5,08	5,07 4,17
SWW8.0X280	80	200	5,08	4,64 3,50	5,08	5,07 3,77	5,08	5,07 3,94	5,08	5,07 4,17	5,08	5,07 4,17	5,08	5,07 4,17	5,08	5,07 4,17	5,08	5,07 4,17	5,08	5,07 4,17
SWW8.0X300	80	220	5,08	4,64 3,50	5,08	5,07 3,77	5,08	5,07 3,94	5,08	5,07 4,17	5,08	5,07 4,17	5,08	5,07 4,17	5,08	5,07 4,17	5,08	5,07 4,17	5,08	5,07 4,17
SWW8.0X320	80	240	5,08	4,64 3,50	5,08	5,07 3,77	5,08	5,07 3,94	5,08	5,07 4,17	5,08	5,07 4,17	5,08	5,07 4,17	5,08	5,07 4,17	5,08	5,07 4,17	5,08	5,07 4,17
SWW8.0X340	80	260	5,08	4,64 3,50	5,08	5,07 3,77	5,08	5,07 3,94	5,08	5,07 4,17	5,08	5,07 4,17	5,08	5,07 4,17	5,08	5,07 4,17	5,08	5,07 4,17	5,08	5,07 4,17
SWW8.0X360	80	280	5,08	4,64 3,50	5,08	5,07 3,77	5,08	5,07 3,94	5,08	5,07 4,17	5,08	5,07 4,17	5,08	5,07 4,17	5,08	5,07 4,17	5,08	5,07 4,17	5,08	5,07 4,17
SWW8.0X380	80	300	5,08	4,64 3,50	5,08	5,07 3,77	5,08	5,07 3,94	5,08	5,07 4,17	5,08	5,07 4,17	5,08	5,07 4,17	5,08	5,07 4,17	5,08	5,07 4,17	5,08	5,07 4,17
SWW8.0X400	80	320	5,08	4,64 3,50	5,08	5,07 3,77	5,08	5,07 3,94	5,08	5,07 4,17	5,08	5,07 4,17	5,08	5,07 4,17	5,08	5,07 4,17	5,08	5,07 4,17	5,08	5,07 4,17

Table continues on next page.

C-F-EU-TG-2023-2 (2<sup>nd</sup> Edition) © 2023 SIMPSON STRONG-TIE COMPANY INC.



### 3.1 Solid Timber Fastening

SWW – Characteristic Tension and Shear Capacities, Perpendicular (90°) to the Grain Timber to Timber C24 (continued)

Product Reference	Thread Length $L_g$ [mm]	Max Advised Wood Thickness $t_1$ [mm]	Tension Capacity $R_{ax,k}$ and Shear Capacity $R_{v,90°k}$ Perpendicular to the Grain Depending on $t_1$ [kN]																	
			Wood Thickness $t_1$ [mm]																	
			36		45		50		60		63		70		75		80		100	
SWW10.0X100	50	50	-	-	6,10	6,56	6,10	6,87	-	-	-	-	-	-	-	-	-	-	-	
SWW10.0X120	50	70	-	-	6,10	6,56	6,10	6,92	6,10	6,99	6,10	6,99	6,10	6,92	5,49	6,56	-	-	-	
SWW10.0X140	80	60	-	-	6,38	6,62	6,38	6,99	6,38	7,06	6,38	7,06	-	-	-	-	-	-	-	
SWW10.0X160	80	80	-	-	6,38	6,62	6,38	6,99	6,38	7,06	6,38	7,06	6,38	7,06	6,38	7,06	6,38	7,06	-	
SWW10.0X180	80	100	-	-	6,38	6,62	6,38	6,99	6,38	7,06	6,38	7,06	6,38	7,06	6,38	7,06	6,38	7,06	6,38	
SWW10.0X200	80	120	-	-	6,38	6,62	6,38	6,99	6,38	7,06	6,38	7,06	6,38	7,06	6,38	7,06	6,38	7,06	6,38	
SWW10.0X220	80	140	-	-	6,38	6,62	6,38	6,99	6,38	7,06	6,38	7,06	6,38	7,06	6,38	7,06	6,38	7,06	6,38	
SWW10.0X240	80	160	-	-	6,38	6,62	6,38	6,99	6,38	7,06	6,38	7,06	6,38	7,06	6,38	7,06	6,38	7,06	6,38	
SWW10.0X260	80	180	-	-	6,38	6,62	6,38	6,99	6,38	7,06	6,38	7,06	6,38	7,06	6,38	7,06	6,38	7,06	6,38	
SWW10.0X280	80	200	-	-	6,38	6,62	6,38	6,99	6,38	7,06	6,38	7,06	6,38	7,06	6,38	7,06	6,38	7,06	6,38	
SWW10.0X300	80	220	-	-	6,38	6,62	6,38	6,99	6,38	7,06	6,38	7,06	6,38	7,06	6,38	7,06	6,38	7,06	6,38	
SWW10.0X320	80	240	-	-	6,38	6,62	6,38	6,99	6,38	7,06	6,38	7,06	6,38	7,06	6,38	7,06	6,38	7,06	6,38	
SWW10.0X340	80	260	-	-	6,38	6,62	6,38	6,99	6,38	7,06	6,38	7,06	6,38	7,06	6,38	7,06	6,38	7,06	6,38	
SWW10.0X360	80	280	-	-	6,38	6,62	6,38	6,99	6,38	7,06	6,38	7,06	6,38	7,06	6,38	7,06	6,38	7,06	6,38	
SWW10.0X380	80	300	-	-	6,38	6,62	6,38	6,99	6,38	7,06	6,38	7,06	6,38	7,06	6,38	7,06	6,38	7,06	6,38	
SWW10.0X400	80	320	-	-	6,38	6,62	6,38	6,99	6,38	7,06	6,38	7,06	6,38	7,06	6,38	7,06	6,38	7,06	6,38	

For dimensions and calculation parameters see p. 44.

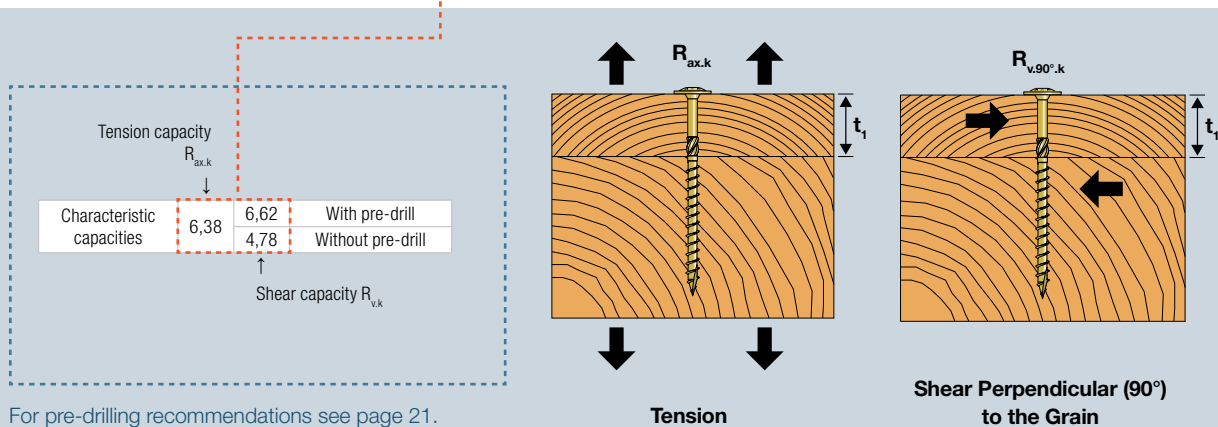

To ensure that the values in this catalog are valid, check that max. 5 mm of the thread is in the first element for partially threaded screws or that max. half the thread +/- 5 mm is in each element for the fully threaded screws.

For additional values in other configurations use Solid Wood – online dimensioning tool. Go to [solidwood.strongtie.eu](http://solidwood.strongtie.eu).

If the screw you are looking for is not shown in this table, it is because the screw cannot fulfil the requirements stated above. In this case, use Solid Wood to determine the capacity of the screw.

### 3.1 Solid Timber Fastening

## Solid-Drive™ SWWZ Structural Washer-Head WOOD Screw for Timber to Timber

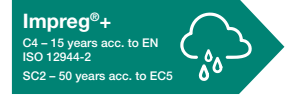

ETA-21/0670

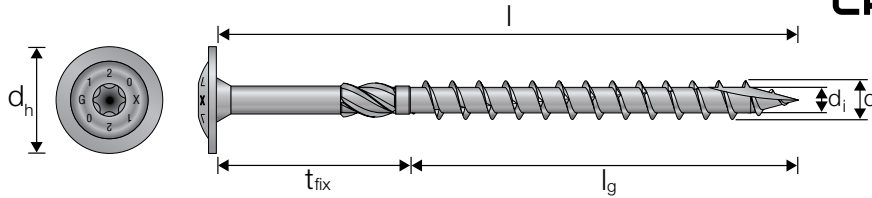

SWWZ – Characteristic Tension and Shear Capacities, Parallel (0°) to the Grain  
Timber to Timber C24

Product Reference	Thread Length L <sub>g</sub> [mm]	Max Advised Wood Thickness t <sub>1</sub> [mm]	Tension Capacity R <sub>ax,k</sub> and Shear Capacity R <sub>v,0°k</sub> Parallel to the Grain Depending on t <sub>1</sub> [kN]																	
			Wood Thickness t <sub>1</sub> [mm]																	
			36		45		50		60		63		70		75		80		100	
SWWZ6.0X90	50	40	3,16	2,91 2,35	3,16	2,91 2,46	-	-	-	-	-	-	-	-	-	-	-	-	-	-
SWWZ6.0X100	50	50	3,16	2,91 2,35	3,16	2,91 2,46	3,16	2,91 2,46	-	-	-	-	-	-	-	-	-	-	-	-
SWWZ6.0X120	50	70	3,16	2,91 2,35	3,16	2,91 2,46	3,16	2,91 2,46	3,16	2,91 2,46	3,16	2,91 2,46	3,16	2,91 2,46	3,16	2,91 2,46	-	-	-	-
SWWZ8.0X90	50	40	5,04	4,63 3,49	4,54	5,06 3,55	-	-	-	-	-	-	-	-	-	-	-	-	-	-
SWWZ8.0X100	50	50	5,04	4,63 3,49	5,04	5,06 3,76	5,04	5,06 3,81	-	-	-	-	-	-	-	-	-	-	-	-
SWWZ8.0X120	80	40	5,08	4,64 3,50	5,08	5,07 3,77	-	-	-	-	-	-	-	-	-	-	-	-	-	-
SWWZ8.0X140	80	60	5,08	4,64 3,50	5,08	5,07 3,77	5,08	5,07 3,94	5,08	5,07 4,17	5,08	5,07 4,17	-	-	-	-	-	-	-	-
SWWZ8.0X180	80	100	5,08	4,64 3,50	5,08	5,07 3,77	5,08	5,07 3,94	5,08	5,07 4,17	5,08	5,07 4,17	5,08	5,07 4,17	5,08	5,07 4,17	5,08	5,07 4,17	5,08	5,07 4,17
SWWZ8.0X200	80	120	5,08	4,64 3,50	5,08	5,07 3,77	5,08	5,07 3,94	5,08	5,07 4,17	5,08	5,07 4,17	5,08	5,07 4,17	5,08	5,07 4,17	5,08	5,07 4,17	5,08	5,07 4,17
SWWZ8.0X240	80	160	5,08	4,64 3,50	5,08	5,07 3,77	5,08	5,07 3,94	5,08	5,07 4,17	5,08	5,07 4,17	5,08	5,07 4,17	5,08	5,07 4,17	5,08	5,07 4,17	5,08	5,07 4,17
SWWZ8.0X300	80	220	5,08	4,64 3,50	5,08	5,07 3,77	5,08	5,07 3,94	5,08	5,07 4,17	5,08	5,07 4,17	5,08	5,07 4,17	5,08	5,07 4,17	5,08	5,07 4,17	5,08	5,07 4,17
SWWZ8.0X340	80	260	5,08	4,64 3,50	5,08	5,07 3,77	5,08	5,07 3,94	5,08	5,07 4,17	5,08	5,07 4,17	5,08	5,07 4,17	5,08	5,07 4,17	5,08	5,07 4,17	5,08	5,07 4,17
SWWZ10.0X160	80	80	-	-	6,38	6,62 4,78	6,38	6,99 4,96	6,38	7,06 5,34	6,38	7,06 5,46	6,38	7,06 5,67	6,38	7,06 5,67	6,38	7,06 5,67	6,38	7,06 5,67
SWWZ10.0X180	80	100	-	-	6,38	6,62 4,78	6,38	6,99 4,96	6,38	7,06 5,34	6,38	7,06 5,46	6,38	7,06 5,67	6,38	7,06 5,67	6,38	7,06 5,67	6,38	7,06 5,67
SWWZ10.0X200	80	120	-	-	6,38	6,62 4,78	6,38	6,99 4,96	6,38	7,06 5,34	6,38	7,06 5,46	6,38	7,06 5,67	6,38	7,06 5,67	6,38	7,06 5,67	6,38	7,06 5,67
SWWZ10.0X240	80	160	-	-	6,38	6,62 4,78	6,38	6,99 4,96	6,38	7,06 5,34	6,38	7,06 5,46	6,38	7,06 5,67	6,38	7,06 5,67	6,38	7,06 5,67	6,38	7,06 5,67

For dimensions and calculation parameters see p. 44.

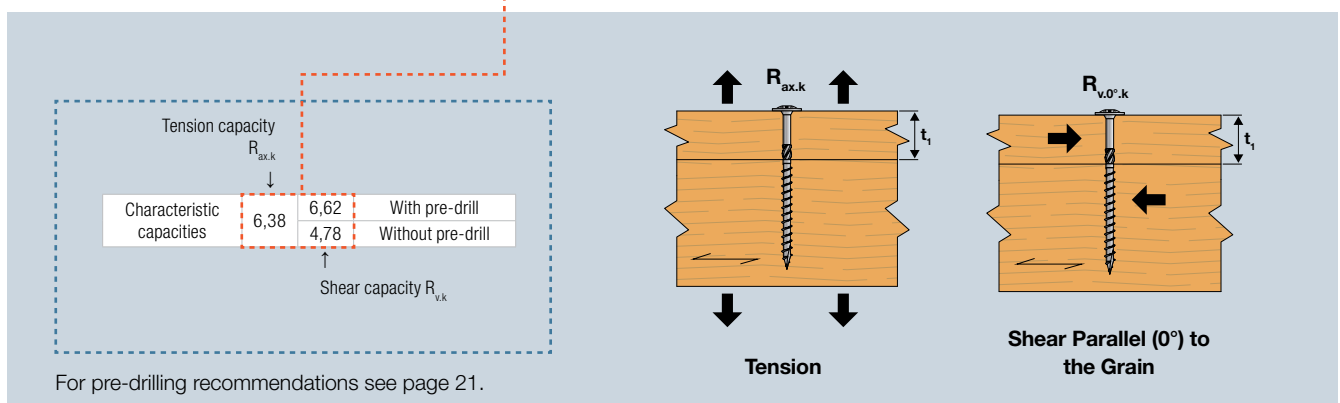

### 3.1 Solid Timber Fastening

#### SWWZ – Characteristic Tension and Shear Capacities, Perpendicular (90°) to the Grain Timber to Timber C24

Product Reference	Thread Length $L_g$ [mm]	Max Advised Wood Thickness $t_1$ [mm]	Tension Capacity $R_{ax,k}$ and Shear Capacity $R_{v,90°k}$ Perpendicular to the Grain Depending on $t_1$ [kN]																	
			Wood Thickness $t_1$ [mm]																	
			36		45		50		60		63		70		75		80		100	
SWWZ6.0X90	50	40	3,16	2,91 2,35	3,16	2,91 2,46	-	-	-	-	-	-	-	-	-	-	-	-	-	
SWWZ6.0X100	50	50	3,16	2,91 2,35	3,16	2,91 2,46	3,16	2,91 2,46	-	-	-	-	-	-	-	-	-	-	-	
SWWZ6.0X120	50	70	3,16	2,91 2,35	3,16	2,91 2,46	3,16	2,91 2,46	3,16	2,91 2,46	3,16	2,91 2,46	3,16	2,91 2,46	-	-	-	-	-	
SWWZ8.0X90	50	40	5,04	4,63 3,49	4,54	5,06 3,55	-	-	-	-	-	-	-	-	-	-	-	-	-	
SWWZ8.0X100	50	50	5,04	4,63 3,49	5,04	5,06 3,76	5,04	5,06 3,81	-	-	-	-	-	-	-	-	-	-	-	
SWWZ8.0X120	80	40	5,08	4,64 3,50	5,08	5,07 3,77	-	-	-	-	-	-	-	-	-	-	-	-	-	
SWWZ8.0X140	80	60	5,08	4,64 3,50	5,08	5,07 3,77	5,08	5,07 3,94	5,08	5,07 4,17	5,08	5,07 4,17	-	-	-	-	-	-	-	
SWWZ8.0X180	80	100	5,08	4,64 3,50	5,08	5,07 3,77	5,08	5,07 3,94	5,08	5,07 4,17	5,08	5,07 4,17	5,08	5,07 4,17	5,08	5,07 4,17	5,08	5,07 4,17	5,08	
SWWZ8.0X200	80	120	5,08	4,64 3,50	5,08	5,07 3,77	5,08	5,07 3,94	5,08	5,07 4,17	5,08	5,07 4,17	5,08	5,07 4,17	5,08	5,07 4,17	5,08	5,07 4,17	5,08	
SWWZ8.0X240	80	160	5,08	4,64 3,50	5,08	5,07 3,77	5,08	5,07 3,94	5,08	5,07 4,17	5,08	5,07 4,17	5,08	5,07 4,17	5,08	5,07 4,17	5,08	5,07 4,17	5,08	
SWWZ8.0X300	80	220	5,08	4,64 3,50	5,08	5,07 3,77	5,08	5,07 3,94	5,08	5,07 4,17	5,08	5,07 4,17	5,08	5,07 4,17	5,08	5,07 4,17	5,08	5,07 4,17	5,08	
SWWZ8.0X340	80	260	5,08	4,64 3,50	5,08	5,07 3,77	5,08	5,07 3,94	5,08	5,07 4,17	5,08	5,07 4,17	5,08	5,07 4,17	5,08	5,07 4,17	5,08	5,07 4,17	5,08	
SWWZ10.0X160	80	80	-	-	6,38	6,62 4,78	6,38	6,99 4,96	6,38	7,06 5,34	6,38	7,06 5,46	6,38	7,06 5,67	6,38	7,06 5,67	6,38	7,06 5,67	6,38	
SWWZ10.0X180	80	100	-	-	6,38	6,62 4,78	6,38	6,99 4,96	6,38	7,06 5,34	6,38	7,06 5,46	6,38	7,06 5,67	6,38	7,06 5,67	6,38	7,06 5,67	6,38	
SWWZ10.0X200	80	120	-	-	6,38	6,62 4,78	6,38	6,99 4,96	6,38	7,06 5,34	6,38	7,06 5,46	6,38	7,06 5,67	6,38	7,06 5,67	6,38	7,06 5,67	6,38	
SWWZ10.0X240	80	160	-	-	6,38	6,62 4,78	6,38	6,99 4,96	6,38	7,06 5,34	6,38	7,06 5,46	6,38	7,06 5,67	6,38	7,06 5,67	6,38	7,06 5,67	6,38	

For dimensions and calculation parameters see p. 44.

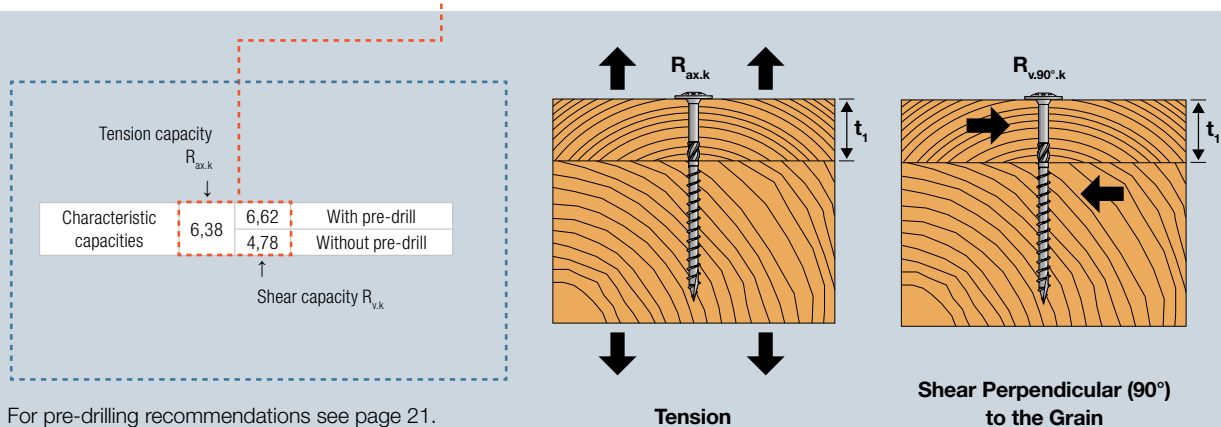

To ensure that the values in this catalog are valid, check that max. 5 mm of the thread is in the first element for partially threaded screws or that max. half the thread +/- 5 mm is in each element for the fully threaded screws.

For additional values in other configurations use Solid Wood – online dimensioning tool. Go to [solidwood.strongtie.eu](http://solidwood.strongtie.eu).

If the screw you are looking for is not shown in this table, it is because the screw cannot fulfil the requirements stated above. In this case, use Solid Wood to determine the capacity of the screw.

### 3.1 Solid Timber Fastening

#### SWW/SWWZ – Minimum Distances for Screws in Shear or Combined Loads<sup>1)</sup> Timber to Timber C24

Outer Thread Diameter d [mm]	Pre-drill	Angle Between Load Direction and Grain = 0°						Angle Between Load Direction and Grain = 90°					
		a <sub>1</sub>	a <sub>2</sub>	a <sub>3,c</sub>	a <sub>3,t</sub>	a <sub>4,c</sub>	a <sub>4,t</sub>	a <sub>1</sub>	a <sub>2</sub>	a <sub>3,c</sub>	a <sub>3,t</sub>	a <sub>4,c</sub>	a <sub>4,t</sub>
6.0	With pre-drill	30	18	42	72	18	18	24	24	42	30	18	42
	Without pre-drill	72	30	60	90	30	30	30	30	60	60	30	60
8.0	With pre-drill	40	24	56	96	24	24	32	32	56	40	24	56
	Without pre-drill	96	40	80	120	40	40	40	40	80	80	40	80
10.0	With pre-drill	50	30	70	120	30	30	40	40	70	50	30	70
	Without pre-drill	120	50	100	150	50	50	50	50	100	100	50	100

<sup>1)</sup> Minimum distances comply with EN 1995-1-1 (Eurocode 5) and ETA21/0670

<sup>2)</sup> Values given in the table is based on the  $\rho_k \leq 350 \text{ kg/m}^3$

<sup>3)</sup> Minimum distances from the unloaded edge perpendicular to the grain may be reduced to  $a_{4,c} = 3 \times d$  if the spacing parallel to the grain ( $a_1$ ) and the end distance ( $a_{3,t}$ ) is at least  $25 \times d$ .

#### SWW/SWWZ – Minimum Distances for Axially Loaded Screws Timber to Timber C24

Outer Thread Diameter d [mm]	a <sub>1</sub>	a <sub>2</sub>	a <sub>3,c</sub>	a <sub>4,c</sub>
6.0	42	30	60	24
8.0	56	40	80	32
10.0	70	50	100	40

\*Valid if the applied centre distances comply with  $a_1, a_2 \geq 25d^2$ .  
Calculation according to EN1995-1-1:2004+A2:2014.

For axially loaded screws installed perpendicular to the surface  $a_{3,t}$  and  $a_{4,t}$  are not relevant. For more info see General Introduction page 24.

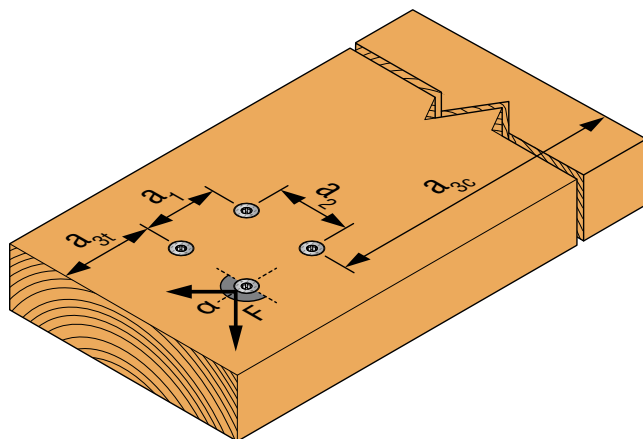

Illustration above shows angle between load direction and grain = 0°

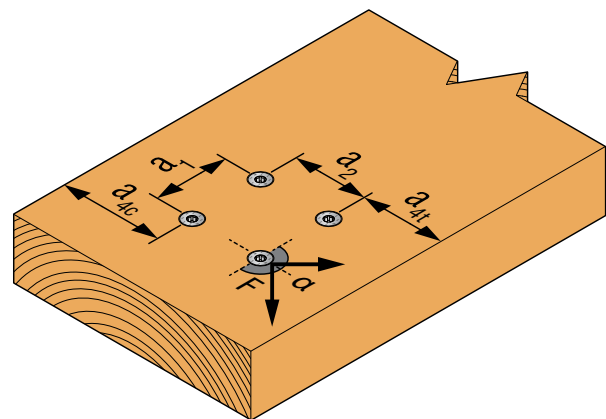

Illustration above shows angle between load direction and grain = 90°

See explanation of  $\alpha$  in General Introduction page 23.



#### Solid Wood Fastener Dimensioning Software

In just four simple steps, Solid Wood guides you through the calculation and selection of fastening solutions suitable for the specific wood structure at hand, all according to Eurocode 5 and our ETA.

Try Solid Wood today. Go to [solidwood.strongtie.eu](http://solidwood.strongtie.eu)

### 3.1 Solid Timber Fastening

## Solid-Drive™ SWC Structural Countersunk WOOD Screw for Timber to Timber

**Yellow Zinc Plated**  
C2 acc. to EN ISO 12944-2  
SC2 – 50 years acc. to EC5

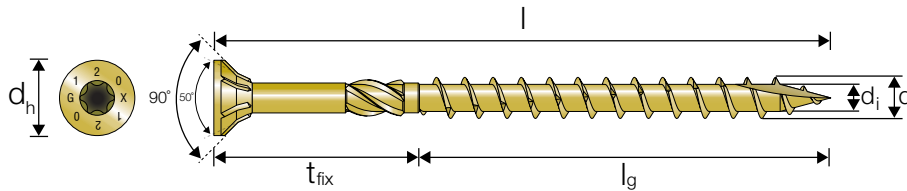

SWC – Characteristic Tension and Shear Capacities, Parallel (0°) to the Grain  
Timber to Timber C24

Product Reference	Thread Length L <sub>g</sub> [mm]	Max Advised Wood Thickness t <sub>1</sub> [mm]	Tension Capacity R <sub>ax,k</sub> and Shear Capacity R <sub>v,0°k</sub> Parallel to the Grain Depending on t <sub>1</sub> [kN]																	
			Wood Thickness t <sub>1</sub> [mm]																	
			36		45		50		60		63		70		75		80		100	
SWC6.0X200	70	130	1,66	2,53 1,97	1,66	2,53 2,09	1,66	2,53 2,09	1,66	2,53 2,09	1,66	2,53 2,09	1,66	2,53 2,09	1,66	2,53 2,09	1,66	2,53 2,09		
SWC6.0X220	70	150	1,66	2,53 1,97	1,66	2,53 2,09	1,66	2,53 2,09	1,66	2,53 2,09	1,66	2,53 2,09	1,66	2,53 2,09	1,66	2,53 2,09	1,66	2,53 2,09		
SWC6.0X240	70	170	1,66	2,53 1,97	1,66	2,53 2,09	1,66	2,53 2,09	1,66	2,53 2,09	1,66	2,53 2,09	1,66	2,53 2,09	1,66	2,53 2,09	1,66	2,53 2,09		
SWC6.0X260	70	190	1,66	2,53 1,97	1,66	2,53 2,09	1,66	2,53 2,09	1,66	2,53 2,09	1,66	2,53 2,09	1,66	2,53 2,09	1,66	2,53 2,09	1,66	2,53 2,09		
SWC6.0X280	70	210	1,66	2,53 1,97	1,66	2,53 2,09	1,66	2,53 2,09	1,66	2,53 2,09	1,66	2,53 2,09	1,66	2,53 2,09	1,66	2,53 2,09	1,66	2,53 2,09		
SWC6.0X300	70	230	1,66	2,53 1,97	1,66	2,53 2,09	1,66	2,53 2,09	1,66	2,53 2,09	1,66	2,53 2,09	1,66	2,53 2,09	1,66	2,53 2,09	1,66	2,53 2,09		
SWC8.0X100	50	50	2,66	4,04 2,90	2,66	4,47 3,17	2,66	4,47 3,21	-	-	-	-	-	-	-	-	-	-		
SWC8.0X120	80	40	2,66	4,04 2,90	2,66	4,47 3,17	-	-	-	-	-	-	-	-	-	-	-	-		
SWC8.0X140	80	60	2,66	4,04 2,90	2,66	4,47 3,17	2,66	4,47 3,33	2,66	4,47 3,57	2,66	4,47 3,57	-	-	-	-	-	-		
SWC8.0X160	80	80	2,66	4,04 2,90	2,66	4,47 3,17	2,66	4,47 3,33	2,66	4,47 3,57	2,66	4,47 3,57	2,66	4,47 3,57	2,66	4,47 3,57	2,66	4,47 3,57		
SWC8.0X180	80	100	2,66	4,04 2,90	2,66	4,47 3,17	2,66	4,47 3,33	2,66	4,47 3,57	2,66	4,47 3,57	2,66	4,47 3,57	2,66	4,47 3,57	2,66	4,47 3,57		
SWC8.0X200	80	120	2,66	4,04 2,90	2,66	4,47 3,17	2,66	4,47 3,33	2,66	4,47 3,57	2,66	4,47 3,57	2,66	4,47 3,57	2,66	4,47 3,57	2,66	4,47 3,57		
SWC8.0X220	80	140	2,66	4,04 2,90	2,66	4,47 3,17	2,66	4,47 3,33	2,66	4,47 3,57	2,66	4,47 3,57	2,66	4,47 3,57	2,66	4,47 3,57	2,66	4,47 3,57		
SWC8.0X240	80	160	2,66	4,04 2,90	2,66	4,47 3,17	2,66	4,47 3,33	2,66	4,47 3,57	2,66	4,47 3,57	2,66	4,47 3,57	2,66	4,47 3,57	2,66	4,47 3,57		
SWC8.0X260	80	180	2,66	4,04 2,90	2,66	4,47 3,17	2,66	4,47 3,33	2,66	4,47 3,57	2,66	4,47 3,57	2,66	4,47 3,57	2,66	4,47 3,57	2,66	4,47 3,57		
SWC8.0X280	80	200	2,66	4,04 2,90	2,66	4,47 3,17	2,66	4,47 3,33	2,66	4,47 3,57	2,66	4,47 3,57	2,66	4,47 3,57	2,66	4,47 3,57	2,66	4,47 3,57		
SWC8.0X300	80	220	2,66	4,04 2,90	2,66	4,47 3,17	2,66	4,47 3,33	2,66	4,47 3,57	2,66	4,47 3,57	2,66	4,47 3,57	2,66	4,47 3,57	2,66	4,47 3,57		
SWC8.0X320	80	240	2,66	4,04 2,90	2,66	4,47 3,17	2,66	4,47 3,33	2,66	4,47 3,57	2,66	4,47 3,57	2,66	4,47 3,57	2,66	4,47 3,57	2,66	4,47 3,57		
SWC8.0X340	80	260	2,66	4,04 2,90	2,66	4,47 3,17	2,66	4,47 3,33	2,66	4,47 3,57	2,66	4,47 3,57	2,66	4,47 3,57	2,66	4,47 3,57	2,66	4,47 3,57		
SWC8.0X360	80	280	2,66	4,04 2,90	2,66	4,47 3,17	2,66	4,47 3,33	2,66	4,47 3,57	2,66	4,47 3,57	2,66	4,47 3,57	2,66	4,47 3,57	2,66	4,47 3,57		
SWC8.0X380	80	300	2,66	4,04 2,90	2,66	4,47 3,17	2,66	4,47 3,33	2,66	4,47 3,57	2,66	4,47 3,57	2,66	4,47 3,57	2,66	4,47 3,57	2,66	4,47 3,57		
SWC8.0X400	80	320	2,66	4,04 2,90	2,66	4,47 3,17	2,66	4,47 3,33	2,66	4,47 3,57	2,66	4,47 3,57	2,66	4,47 3,57	2,66	4,47 3,57	2,66	4,47 3,57		

Table continues on next page.

### 3.1 Solid Timber Fastening

SWC – Characteristic Tension and Shear Capacities, Parallel (0°) to the Grain  
Timber to Timber C24 (continued)

Product Reference	Thread Length $L_g$ [mm]	Max Advised Wood Thickness $t_1$ [mm]	Tension Capacity $R_{ax,k}$ and Shear Capacity $R_{v,0^\circ,k}$ Parallel to the Grain Depending on $t_1$ [kN]																	
			Wood Thickness $t_1$ [mm]																	
			36		45		50		60		63		70		75		80		100	
SWC10.0X100	50	50	-	-	3,55	5,92	3,55	6,24	-	-	-	-	-	-	-	-	-	-	-	
			-	-		3,89	3,55	3,87	-	-	-	-	-	-	-	-	-	-	-	
SWC10.0X120	50	70	-	-	3,55	5,92	3,55	6,28	3,55	6,35	3,55	6,35	3,55	6,28	3,55	5,92	-	-	-	
			-	-		4,08	3,55	4,25	3,55	4,46	3,55	4,47	3,55	4,25	3,55	4,08	-	-	-	
SWC10.0X140	80	60	-	-	3,55	5,92	3,55	6,28	3,55	6,35	3,55	6,35	-	-	-	-	-	-	-	
			-	-		4,08	3,55	4,25	3,55	4,63	3,55	4,75	-	-	-	-	-	-	-	
SWC10.0X160	80	80	-	-	3,55	5,92	3,55	6,28	3,55	6,35	3,55	6,35	3,55	6,35	3,55	6,35	3,55	6,35	-	
			-	-		4,08	3,55	4,25	3,55	4,63	3,55	4,75	3,55	4,96	3,55	4,96	3,55	4,96	-	
SWC10.0X180	80	100	-	-	3,55	5,92	3,55	6,28	3,55	6,35	3,55	6,35	3,55	6,35	3,55	6,35	3,55	6,35	3,55	
			-	-		4,08	3,55	4,25	3,55	4,63	3,55	4,75	3,55	4,96	3,55	4,96	3,55	4,96	3,55	
SWC10.0X200	80	120	-	-	3,55	5,92	3,55	6,28	3,55	6,35	3,55	6,35	3,55	6,35	3,55	6,35	3,55	6,35	3,55	
			-	-		4,08	3,55	4,25	3,55	4,63	3,55	4,75	3,55	4,96	3,55	4,96	3,55	4,96	3,55	
SWC10.0X220	80	140	-	-	3,55	5,92	3,55	6,28	3,55	6,35	3,55	6,35	3,55	6,35	3,55	6,35	3,55	6,35	3,55	
			-	-		4,08	3,55	4,25	3,55	4,63	3,55	4,75	3,55	4,96	3,55	4,96	3,55	4,96	3,55	
SWC10.0X240	80	160	-	-	3,55	5,92	3,55	6,28	3,55	6,35	3,55	6,35	3,55	6,35	3,55	6,35	3,55	6,35	3,55	
			-	-		4,08	3,55	4,25	3,55	4,63	3,55	4,75	3,55	4,96	3,55	4,96	3,55	4,96	3,55	
SWC10.0X260	80	180	-	-	3,55	5,92	3,55	6,28	3,55	6,35	3,55	6,35	3,55	6,35	3,55	6,35	3,55	6,35	3,55	
			-	-		4,08	3,55	4,25	3,55	4,63	3,55	4,75	3,55	4,96	3,55	4,96	3,55	4,96	3,55	
SWC10.0X280	80	200	-	-	3,55	5,92	3,55	6,28	3,55	6,35	3,55	6,35	3,55	6,35	3,55	6,35	3,55	6,35	3,55	
			-	-		4,08	3,55	4,25	3,55	4,63	3,55	4,75	3,55	4,96	3,55	4,96	3,55	4,96	3,55	
SWC10.0X300	80	220	-	-	3,55	5,92	3,55	6,28	3,55	6,35	3,55	6,35	3,55	6,35	3,55	6,35	3,55	6,35	3,55	
			-	-		4,08	3,55	4,25	3,55	4,63	3,55	4,75	3,55	4,96	3,55	4,96	3,55	4,96	3,55	
SWC10.0X320	80	240	-	-	3,55	5,92	3,55	6,28	3,55	6,35	3,55	6,35	3,55	6,35	3,55	6,35	3,55	6,35	3,55	
			-	-		4,08	3,55	4,25	3,55	4,63	3,55	4,75	3,55	4,96	3,55	4,96	3,55	4,96	3,55	
SWC10.0X340	80	260	-	-	3,55	5,92	3,55	6,28	3,55	6,35	3,55	6,35	3,55	6,35	3,55	6,35	3,55	6,35	3,55	
			-	-		4,08	3,55	4,25	3,55	4,63	3,55	4,75	3,55	4,96	3,55	4,96	3,55	4,96	3,55	
SWC10.0X360	80	280	-	-	3,55	5,92	3,55	6,28	3,55	6,35	3,55	6,35	3,55	6,35	3,55	6,35	3,55	6,35	3,55	
			-	-		4,08	3,55	4,25	3,55	4,63	3,55	4,75	3,55	4,96	3,55	4,96	3,55	4,96	3,55	
SWC10.0X380	80	300	-	-	3,55	5,92	3,55	6,28	3,55	6,35	3,55	6,35	3,55	6,35	3,55	6,35	3,55	6,35	3,55	
			-	-		4,08	3,55	4,25	3,55	4,63	3,55	4,75	3,55	4,96	3,55	4,96	3,55	4,96	3,55	
SWC10.0X400	80	320	-	-	3,55	5,92	3,55	6,28	3,55	6,35	3,55	6,35	3,55	6,35	3,55	6,35	3,55	6,35	3,55	
			-	-		4,08	3,55	4,25	3,55	4,63	3,55	4,75	3,55	4,96	3,55	4,96	3,55	4,96	3,55	

For dimensions and calculation parameters see p. 48.

Tension capacity $R_{ax,k}$		
Characteristic capacities	3,55	5,92
		4,08
		With pre-drill
		Without pre-drill
Shear capacity $R_{v,k}$		

For pre-drilling recommendations see page 21.

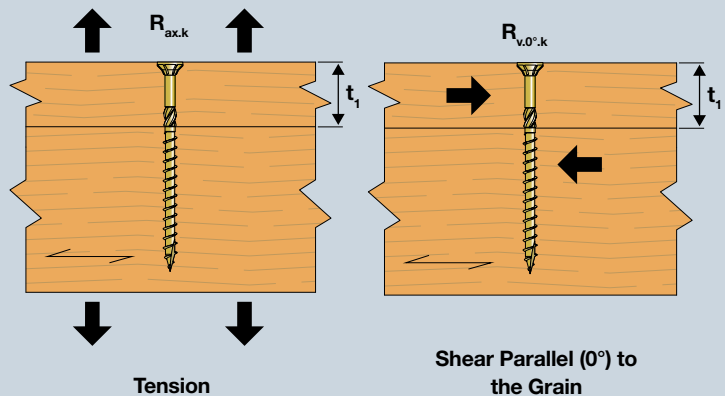

To ensure that the values in this catalog are valid, check that max. 5 mm of the thread is in the first element for partially threaded screws or that max. half the thread +/- 5 mm is in each element for the fully threaded screws.

For additional values in other configurations use Solid Wood – online dimensioning tool. Go to [solidwood.strongtie.eu](http://solidwood.strongtie.eu).

If the screw you are looking for is not shown in this table, it is because the screw cannot fulfil the requirements stated above. In this case, use Solid Wood to determine the capacity of the screw.



### 3.1 Solid Timber Fastening

SWC – Characteristic Tension and Shear Capacities, Perpendicular (90°) to the Grain  
Timber to Timber C24

Product Reference	Thread Length $L_g$ [mm]	Max Advised Wood Thickness $t_f$ [mm]	Tension Capacity $R_{ax,k}$ and Shear Capacity $R_{v,90°k}$ Perpendicular to the Grain Depending on $t_f$ [kN]																	
			Wood Thickness $t_f$ [mm]																	
			36		45		50		60		63		70		75		80		100	
SWC6.0X200	70	130	1,66	2,53 1,97	1,66	2,53 2,09	1,66	2,53 2,09	1,66	2,53 2,09	1,66	2,53 2,09	1,66	2,53 2,09	1,66	2,53 2,09	1,66	2,53 2,09	1,66	2,53 2,09
SWC6.0X220	70	150	1,66	2,53 1,97	1,66	2,53 2,09	1,66	2,53 2,09	1,66	2,53 2,09	1,66	2,53 2,09	1,66	2,53 2,09	1,66	2,53 2,09	1,66	2,53 2,09	1,66	2,53 2,09
SWC6.0X240	70	170	1,66	2,53 1,97	1,66	2,53 2,09	1,66	2,53 2,09	1,66	2,53 2,09	1,66	2,53 2,09	1,66	2,53 2,09	1,66	2,53 2,09	1,66	2,53 2,09	1,66	2,53 2,09
SWC6.0X260	70	190	1,66	2,53 1,97	1,66	2,53 2,09	1,66	2,53 2,09	1,66	2,53 2,09	1,66	2,53 2,09	1,66	2,53 2,09	1,66	2,53 2,09	1,66	2,53 2,09	1,66	2,53 2,09
SWC6.0X280	70	210	1,66	2,53 1,97	1,66	2,53 2,09	1,66	2,53 2,09	1,66	2,53 2,09	1,66	2,53 2,09	1,66	2,53 2,09	1,66	2,53 2,09	1,66	2,53 2,09	1,66	2,53 2,09
SWC6.0X300	70	230	1,66	2,53 1,97	1,66	2,53 2,09	1,66	2,53 2,09	1,66	2,53 2,09	1,66	2,53 2,09	1,66	2,53 2,09	1,66	2,53 2,09	1,66	2,53 2,09	1,66	2,53 2,09
SWC8.0X100	50	50	2,66	4,04 2,90	2,66	4,47 3,17	2,66	4,47 3,21	-	-	-	-	-	-	-	-	-	-	-	-
SWC8.0X120	80	40	2,66	4,04 2,90	2,66	4,47 3,17	-	-	-	-	-	-	-	-	-	-	-	-	-	-
SWC8.0X140	80	60	2,66	4,04 2,90	2,66	4,47 3,17	2,66	4,47 3,33	2,66	4,47 3,57	2,66	4,47 3,57	-	-	-	-	-	-	-	-
SWC8.0X160	80	80	2,66	4,04 2,90	2,66	4,47 3,17	2,66	4,47 3,33	2,66	4,47 3,57	2,66	4,47 3,57	2,66	4,47 3,57	2,66	4,47 3,57	2,66	4,47 3,57	-	-
SWC8.0X180	80	100	2,66	4,04 2,90	2,66	4,47 3,17	2,66	4,47 3,33	2,66	4,47 3,57	2,66	4,47 3,57	2,66	4,47 3,57	2,66	4,47 3,57	2,66	4,47 3,57	2,66	4,47 3,57
SWC8.0X200	80	120	2,66	4,04 2,90	2,66	4,47 3,17	2,66	4,47 3,33	2,66	4,47 3,57	2,66	4,47 3,57	2,66	4,47 3,57	2,66	4,47 3,57	2,66	4,47 3,57	2,66	4,47 3,57
SWC8.0X220	80	140	2,66	4,04 2,90	2,66	4,47 3,17	2,66	4,47 3,33	2,66	4,47 3,57	2,66	4,47 3,57	2,66	4,47 3,57	2,66	4,47 3,57	2,66	4,47 3,57	2,66	4,47 3,57
SWC8.0X240	80	160	2,66	4,04 2,90	2,66	4,47 3,17	2,66	4,47 3,33	2,66	4,47 3,57	2,66	4,47 3,57	2,66	4,47 3,57	2,66	4,47 3,57	2,66	4,47 3,57	2,66	4,47 3,57
SWC8.0X260	80	180	2,66	4,04 2,90	2,66	4,47 3,17	2,66	4,47 3,33	2,66	4,47 3,57	2,66	4,47 3,57	2,66	4,47 3,57	2,66	4,47 3,57	2,66	4,47 3,57	2,66	4,47 3,57
SWC8.0X280	80	200	2,66	4,04 2,90	2,66	4,47 3,17	2,66	4,47 3,33	2,66	4,47 3,57	2,66	4,47 3,57	2,66	4,47 3,57	2,66	4,47 3,57	2,66	4,47 3,57	2,66	4,47 3,57
SWC8.0X300	80	220	2,66	4,04 2,90	2,66	4,47 3,17	2,66	4,47 3,33	2,66	4,47 3,57	2,66	4,47 3,57	2,66	4,47 3,57	2,66	4,47 3,57	2,66	4,47 3,57	2,66	4,47 3,57
SWC8.0X320	80	240	2,66	4,04 2,90	2,66	4,47 3,17	2,66	4,47 3,33	2,66	4,47 3,57	2,66	4,47 3,57	2,66	4,47 3,57	2,66	4,47 3,57	2,66	4,47 3,57	2,66	4,47 3,57
SWC8.0X340	80	260	2,66	4,04 2,90	2,66	4,47 3,17	2,66	4,47 3,33	2,66	4,47 3,57	2,66	4,47 3,57	2,66	4,47 3,57	2,66	4,47 3,57	2,66	4,47 3,57	2,66	4,47 3,57
SWC8.0X360	80	280	2,66	4,04 2,90	2,66	4,47 3,17	2,66	4,47 3,33	2,66	4,47 3,57	2,66	4,47 3,57	2,66	4,47 3,57	2,66	4,47 3,57	2,66	4,47 3,57	2,66	4,47 3,57
SWC8.0X380	80	300	2,66	4,04 2,90	2,66	4,47 3,17	2,66	4,47 3,33	2,66	4,47 3,57	2,66	4,47 3,57	2,66	4,47 3,57	2,66	4,47 3,57	2,66	4,47 3,57	2,66	4,47 3,57
SWC8.0X400	80	320	2,66	4,04 2,90	2,66	4,47 3,17	2,66	4,47 3,33	2,66	4,47 3,57	2,66	4,47 3,57	2,66	4,47 3,57	2,66	4,47 3,57	2,66	4,47 3,57	2,66	4,47 3,57

Table continues on next page.

### 3.1 Solid Timber Fastening

#### SWC – Characteristic Tension and Shear Capacities, Perpendicular (90°) to the Grain Timber to Timber C24 (continued)

Timber to Timber Fastening

Product Reference	Thread Length $L_g$ [mm]	Max Advised Wood Thickness $t_f$ [mm]	Tension Capacity $R_{ax,k}$ and Shear Capacity $R_{v,90^\circ,k}$ Perpendicular to the Grain Depending on $t_f$ [kN]																	
			Wood Thickness $t_f$ [mm]																	
			36		45		50		60		63		70		75		80		100	
SWC10.0X100	50	50	-	-	3,55	5,92	3,55	6,24	-	-	-	-	-	-	-	-	-	-	-	
			-	-	3,55	3,89	3,55	3,87	-	-	-	-	-	-	-	-	-	-	-	
			-	-	3,55	5,92	3,55	6,28	3,55	6,35	3,55	6,35	3,55	6,28	3,55	5,92	-	-	-	
			-	-	3,55	4,08	3,55	4,25	3,55	4,46	3,55	4,47	3,55	4,25	3,55	4,08	-	-	-	
SWC10.0X140	80	60	-	-	3,55	5,92	3,55	6,28	3,55	6,35	3,55	6,35	-	-	-	-	-	-	-	
			-	-	3,55	4,08	3,55	4,25	3,55	4,63	3,55	4,75	-	-	-	-	-	-	-	
SWC10.0X160	80	80	-	-	3,55	5,92	3,55	6,28	3,55	6,35	3,55	6,35	3,55	6,35	3,55	6,35	3,55	6,35	-	
			-	-	3,55	4,08	3,55	4,25	3,55	4,63	3,55	4,75	3,55	4,96	3,55	4,96	3,55	4,96	-	
SWC10.0X180	80	100	-	-	3,55	5,92	3,55	6,28	3,55	6,35	3,55	6,35	3,55	6,35	3,55	6,35	3,55	6,35	3,55	
			-	-	3,55	4,08	3,55	4,25	3,55	4,63	3,55	4,75	3,55	4,96	3,55	4,96	3,55	4,96	3,55	
SWC10.0X200	80	120	-	-	3,55	5,92	3,55	6,28	3,55	6,35	3,55	6,35	3,55	6,35	3,55	6,35	3,55	6,35	3,55	
			-	-	3,55	4,08	3,55	4,25	3,55	4,63	3,55	4,75	3,55	4,96	3,55	4,96	3,55	4,96	3,55	
SWC10.0X220	80	140	-	-	3,55	5,92	3,55	6,28	3,55	6,35	3,55	6,35	3,55	6,35	3,55	6,35	3,55	6,35	3,55	
			-	-	3,55	4,08	3,55	4,25	3,55	4,63	3,55	4,75	3,55	4,96	3,55	4,96	3,55	4,96	3,55	
SWC10.0X240	80	160	-	-	3,55	5,92	3,55	6,28	3,55	6,35	3,55	6,35	3,55	6,35	3,55	6,35	3,55	6,35	3,55	
			-	-	3,55	4,08	3,55	4,25	3,55	4,63	3,55	4,75	3,55	4,96	3,55	4,96	3,55	4,96	3,55	
SWC10.0X260	80	180	-	-	3,55	5,92	3,55	6,28	3,55	6,35	3,55	6,35	3,55	6,35	3,55	6,35	3,55	6,35	3,55	
			-	-	3,55	4,08	3,55	4,25	3,55	4,63	3,55	4,75	3,55	4,96	3,55	4,96	3,55	4,96	3,55	
SWC10.0X280	80	200	-	-	3,55	5,92	3,55	6,28	3,55	6,35	3,55	6,35	3,55	6,35	3,55	6,35	3,55	6,35	3,55	
			-	-	3,55	4,08	3,55	4,25	3,55	4,63	3,55	4,75	3,55	4,96	3,55	4,96	3,55	4,96	3,55	
SWC10.0X300	80	220	-	-	3,55	5,92	3,55	6,28	3,55	6,35	3,55	6,35	3,55	6,35	3,55	6,35	3,55	6,35	3,55	
			-	-	3,55	4,08	3,55	4,25	3,55	4,63	3,55	4,75	3,55	4,96	3,55	4,96	3,55	4,96	3,55	
SWC10.0X320	80	240	-	-	3,55	5,92	3,55	6,28	3,55	6,35	3,55	6,35	3,55	6,35	3,55	6,35	3,55	6,35	3,55	
			-	-	3,55	4,08	3,55	4,25	3,55	4,63	3,55	4,75	3,55	4,96	3,55	4,96	3,55	4,96	3,55	
SWC10.0X340	80	260	-	-	3,55	5,92	3,55	6,28	3,55	6,35	3,55	6,35	3,55	6,35	3,55	6,35	3,55	6,35	3,55	
			-	-	3,55	4,08	3,55	4,25	3,55	4,63	3,55	4,75	3,55	4,96	3,55	4,96	3,55	4,96	3,55	
SWC10.0X360	80	280	-	-	3,55	5,92	3,55	6,28	3,55	6,35	3,55	6,35	3,55	6,35	3,55	6,35	3,55	6,35	3,55	
			-	-	3,55	4,08	3,55	4,25	3,55	4,63	3,55	4,75	3,55	4,96	3,55	4,96	3,55	4,96	3,55	
SWC10.0X380	80	300	-	-	3,55	5,92	3,55	6,28	3,55	6,35	3,55	6,35	3,55	6,35	3,55	6,35	3,55	6,35	3,55	
			-	-	3,55	4,08	3,55	4,25	3,55	4,63	3,55	4,75	3,55	4,96	3,55	4,96	3,55	4,96	3,55	
SWC10.0X400	80	320	-	-	3,55	5,92	3,55	6,28	3,55	6,35	3,55	6,35	3,55	6,35	3,55	6,35	3,55	6,35	3,55	
			-	-	3,55	4,08	3,55	4,25	3,55	4,63	3,55	4,75	3,55	4,96	3,55	4,96	3,55	4,96	3,55	

For dimensions and calculation parameters see p. 48.

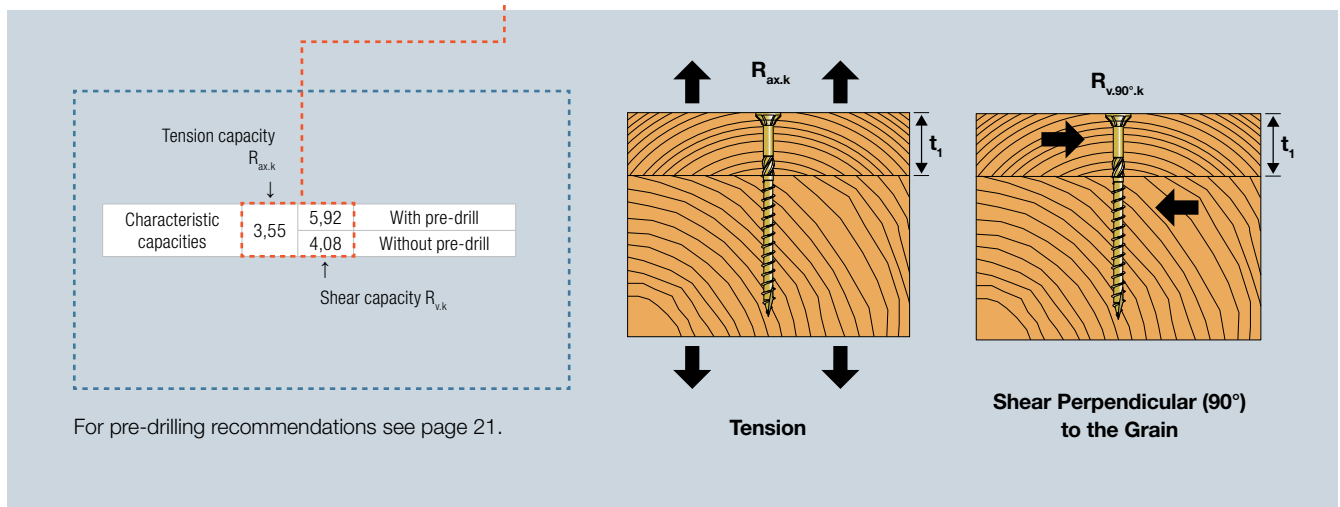

To ensure that the values in this catalog are valid, check that max. 5 mm of the thread is in the first element for partial threaded screws or that max. half the thread +/- 5 mm is in each element for the fully threaded screws.

For additional values in other configurations use Solid Wood – online dimensioning tool. Go to [solidwood.strongtie.eu](http://solidwood.strongtie.eu).

If you are looking for a screw that is not shown in this table, it is because the screw cannot fulfil the requirements stated above. In this case, use Solid Wood to determine the capacity of the screw.

### 3.1 Solid Timber Fastening

#### SWC – Minimum Distances for Screws in Shear or Combined Loads<sup>1)</sup> Timber to Timber C24

Outer Thread Diameter d [mm]	Pre-drill	Angle Between Load Direction and Grain = 0°						Angle Between Load Direction and Grain = 90°					
		a <sub>1</sub>	a <sub>2</sub>	a <sub>3,c</sub>	a <sub>3,t</sub>	a <sub>4,c</sub>	a <sub>4,t</sub>	a <sub>1</sub>	a <sub>2</sub>	a <sub>3,c</sub>	a <sub>3,t</sub>	a <sub>4,c</sub>	a <sub>4,t</sub>
6.0	With pre-drill	30	18	42	72	18	18	24	24	42	30	18	42
	Without pre-drill	72	30	60	90	30	30	30	30	60	60	30	60
8.0	With pre-drill	40	24	56	96	24	24	32	32	56	40	24	56
	Without pre-drill	96	40	80	120	40	40	40	40	80	80	40	80
10.0	With pre-drill	50	30	70	120	30	30	40	40	70	50	30	70
	Without pre-drill	120	50	100	150	50	50	50	50	100	100	50	100

<sup>1)</sup> Minimum distances comply with EN 1995-1-1 (Eurocode 5) and ETA21/0670

<sup>2)</sup> Values given in the table is based on the  $\rho_k \leq 350 \text{ kg/m}^3$

<sup>3)</sup> Minimum distances from the unloaded edge perpendicular to the grain may be reduced to  $a_{4,c} = 3 \times d$  if the spacing parallel to the grain ( $a_1$ ) and the end distance ( $a_{3,t}$ ) is at least  $25 \times d$ .

#### SWC – Minimum Distances for Axially Loaded Screws Timber to Timber C24

Outer Thread Diameter d [mm]	a <sub>1</sub>	a <sub>2</sub>	a <sub>3,c</sub>	a <sub>4,c</sub>
6.0	42	30	60	24
8.0	56	40	80	32
10.0	70	50	100	40

\*Valid if the applied centre distances comply with  $a_1, a_2 \geq 25d^2$ .  
Calculation according to EN1995-1-1:2004+A2:2014.

For axially loaded screws installed perpendicular to the surface  $a_{3,t}$  and  $a_{4,t}$  are not relevant. For more info see General Introduction page 24.

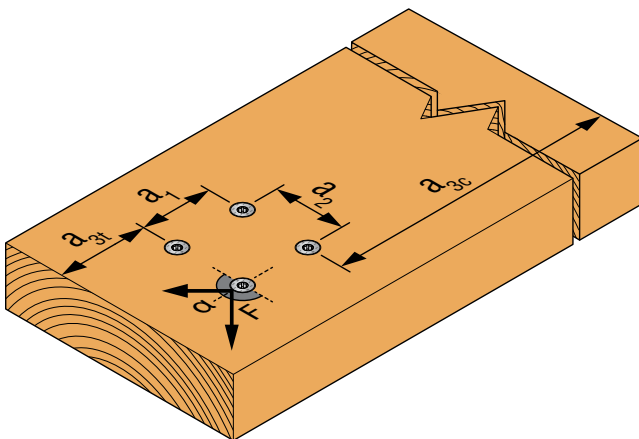

Illustration above shows angle between load direction and grain = 0°

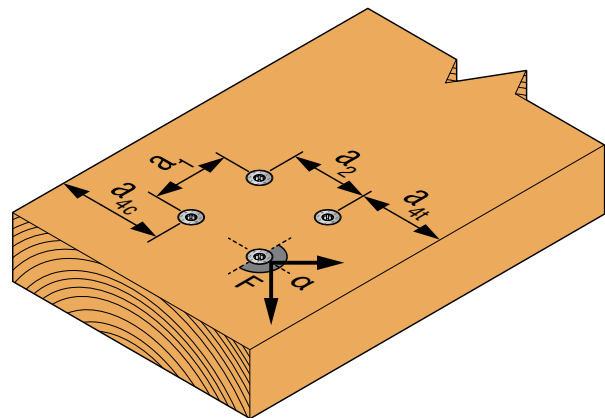

Illustration above shows angle between load direction and grain = 90°

See explanation of  $\alpha$  in General Introduction page 23.



#### Solid Wood Fastener Dimensioning Software

In just four simple steps, Solid Wood guides you through the calculation and selection of fastening solutions suitable for the specific wood structure at hand, all according to Eurocode 5 and our ETA.

Try Solid Wood today. Go to [solidwood.strongtie.eu](http://solidwood.strongtie.eu)

### 3.1 Solid Timber Fastening

## Solid-Drive™ SWD Double Threaded WOOD Screw for Timber to Timber

Protec® +

C3 acc. to EN ISO 12944-2  
SC2 – 50 years acc. to EC5



ETA-21/0670

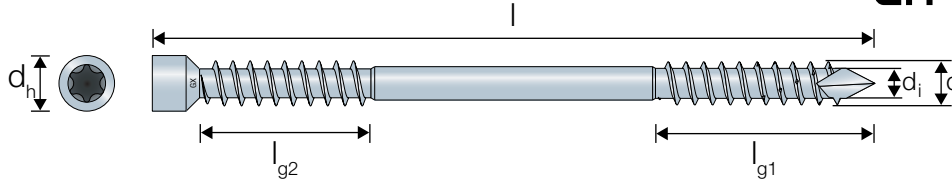

SWD – Characteristic Tension and Shear Capacities, Parallel (0°) to the Grain  
Timber to Timber C24

Product Reference	Thread Length L <sub>g</sub> [mm]	Max Advised Wood Thickness t <sub>1</sub> [mm]	Tension Capacity R <sub>ax,k</sub> and Shear Capacity R <sub>v,0°k</sub> Parallel to the Grain Depending on t <sub>1</sub> [kN]																	
			Wood Thickness t <sub>1</sub> [mm]																	
			36	45	50	60	63	70	75	80	100	36	45	50	60	63	70	75	80	100
SWD6.5X65	28	37	1,91	2,82 2,07	-	-	-	-	-	-	-	-	-	-	-	-	-	-	-	
SWD6.5X90	40	50	2,98	3,28 2,57	2,98	3,28 2,76	2,98	3,28 2,69	-	-	-	-	-	-	-	-	-	-	-	
SWD6.5X130	40	90	2,98	3,28 2,57	2,98	3,28 2,76	2,98	3,28 2,76	2,98	3,28 2,76	2,98	3,28 2,76	2,98	3,28 2,76	2,98	3,28 2,76	2,98	3,28 2,76	-	-
SWD6.5X160	65	95	3,21	3,84 3,13	4,01	3,84 3,32	4,45	3,84 3,32	5,21	3,84 3,32	5,21	3,84 3,32	5,21	3,84 3,32	5,21	3,84 3,32	5,21	3,84 3,32	5,21	3,84 3,32
SWD6.5X190	80	110	3,21	4,17 3,36	4,01	4,17 3,65	4,45	4,17 3,65	5,34	4,17 3,65	5,61	4,17 3,65	6,23	4,17 3,65	6,55	4,17 3,65	6,55	4,17 3,65	6,55	4,17 3,65
SWD6.5X220	95	125	3,21	4,51 3,36	4,01	4,51 3,74	4,45	4,51 3,74	5,34	4,51 3,74	5,61	4,51 3,74	6,23	4,51 3,74	6,68	4,51 3,74	7,12	4,51 3,74	7,88	4,51 3,74
SWD8.0X90	40	50	3,30	4,44 3,30	3,30	4,92 3,34	3,30	4,67 3,37	-	-	-	-	-	-	-	-	-	-	-	-
SWD8.0X130	40	90	3,30	4,44 3,30	3,30	4,92 3,57	3,30	4,92 3,73	3,30	4,92 4,00	3,30	4,92 4,00	3,30	4,92 4,00	3,30	4,92 3,90	3,30	4,92 3,73	-	-
SWD8.0X160	65	95	3,77	5,10 3,96	4,72	5,57 4,22	5,24	5,57 4,39	5,92	5,57 4,66	5,92	5,57 4,66	5,92	5,57 4,66	5,92	5,57 4,66	5,92	5,57 4,66	5,92	5,57 4,66
SWD8.0X190	80	110	3,77	5,49 4,35	4,72	5,97 4,62	5,24	5,97 4,78	6,29	5,97 5,05	6,60	5,97 5,05	7,34	5,97 5,05	7,49	5,97 5,05	7,49	5,97 5,05	7,49	5,97 5,05
SWD8.0X220	95	125	3,77	5,88 4,43	4,72	6,36 5,01	5,24	6,36 5,17	6,29	6,36 5,44	6,60	6,36 5,44	7,34	6,36 5,44	7,86	6,36 5,44	8,38	6,36 5,44	9,07	6,36 5,44
SWD8.0X245	107	138	3,77	6,20 4,43	4,72	6,67 5,04	5,24	6,67 5,37	6,29	6,67 5,76	6,60	6,67 5,76	7,34	6,67 5,76	7,86	6,67 5,76	8,38	6,67 5,76	10,38	6,67 5,76
SWD8.0X275	107	168	3,77	6,20 4,43	4,72	6,67 5,04	5,24	6,67 5,37	6,29	6,67 5,76	6,60	6,67 5,76	7,34	6,67 5,76	7,86	6,67 5,76	8,38	6,67 5,76	10,38	6,67 5,76
SWD8.0X300	135	165	3,77	6,79 4,43	4,72	7,41 5,04	5,24	7,41 5,37	6,29	7,41 5,91	6,60	7,41 5,91	7,34	7,41 5,91	7,86	7,41 5,91	8,38	7,41 5,91	10,48	7,41 5,91
SWD8.0X330	135	195	3,77	6,79 4,43	4,72	7,41 5,04	5,24	7,41 5,37	6,29	7,41 5,91	6,60	7,41 5,91	7,34	7,41 5,91	7,86	7,41 5,91	8,38	7,41 5,91	10,48	7,41 5,91

For dimensions and calculation parameters see p. 50.

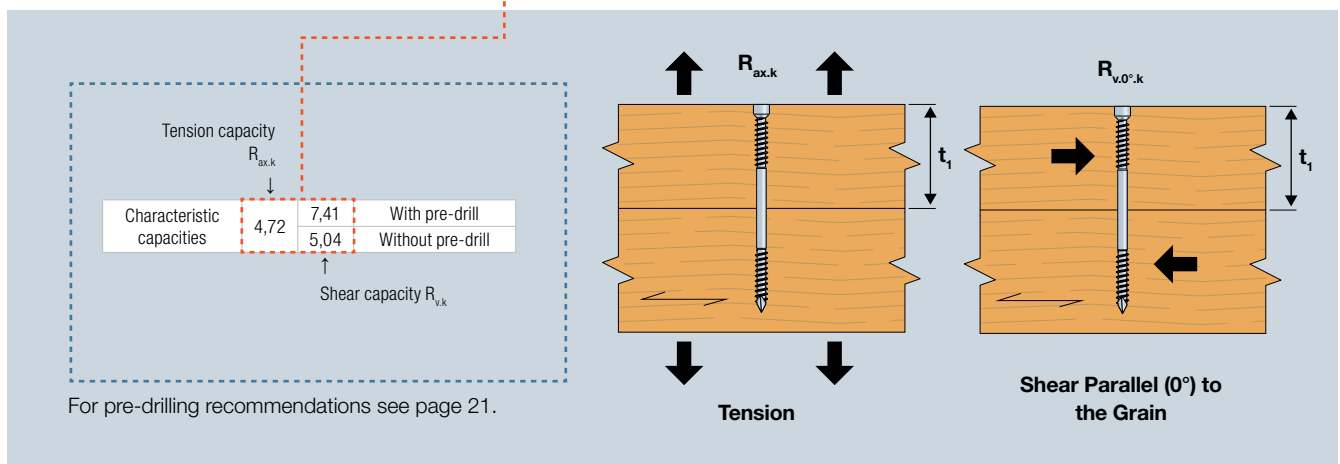

### 3.1 Solid Timber Fastening

#### SWD – Characteristic Tension and Shear Capacities, Perpendicular (90°) to the Grain Timber to Timber C24

Product Reference	Thread Length $L_g$ [mm]	Max Advised Wood Thickness $t_f$ [mm]	Tension Capacity $R_{ax,k}$ and Shear Capacity $R_{v,90°k}$ Perpendicular to the Grain Depending on $t_f$ [kN]																			
			Wood Thickness $t_f$ [mm]																			
			36	45	50	60	63	70	75	80	100	36	45	50	60	63	70	75	80	100		
SWD6.5X65	28	37	1,91	2,82 2,07	-	-	-	-	-	-	-	-	-	-	-	-	-	-	-	-	-	
SWD6.5X90	40	50	2,98	3,28 2,57	2,98	3,28 2,76	2,98	3,28 2,69	-	-	-	-	-	-	-	-	-	-	-	-	-	
SWD6.5X130	40	90	2,98	3,28 2,57	2,98	3,28 2,76	2,98	3,28 2,76	2,98	3,28 2,76	2,98	3,28 2,76	2,98	3,28 2,76	2,98	3,28 2,76	2,98	3,28 2,76	-	-	-	
SWD6.5X160	65	95	3,21	3,84 3,13	4,01	3,84 3,32	4,45	3,84 3,32	5,21	3,84 3,32	5,21	3,84 3,32	5,21	3,84 3,32	5,21	3,84 3,32	5,21	3,84 3,32	5,21	3,84 3,32	5,21	3,84 3,32
SWD6.5X190	80	110	3,21	4,17 3,36	4,01	4,17 3,65	4,45	4,17 3,65	5,34	4,17 3,65	5,61	4,17 3,65	6,23	4,17 3,65	6,55	4,17 3,65	6,55	4,17 3,65	6,55	4,17 3,65	6,55	4,17 3,65
SWD6.5X220	95	125	3,21	4,51 3,36	4,01	4,51 3,74	4,45	4,51 3,74	5,34	4,51 3,74	5,61	4,51 3,74	6,23	4,51 3,74	6,68	4,51 3,74	7,12	4,51 3,74	7,88	4,51 3,74	7,88	4,51 3,74
SWD8.0X90	40	50	3,30	4,44 3,30	3,30	4,92 3,34	3,30	4,67 3,37	-	-	-	-	-	-	-	-	-	-	-	-	-	-
SWD8.0X130	40	90	3,30	4,44 3,30	3,30	4,92 3,57	3,30	4,92 3,73	3,30	4,92 4,00	3,30	4,92 4,00	3,30	4,92 4,00	3,30	4,92 3,90	3,30	4,92 3,73	-	-	-	-
SWD8.0X160	65	95	3,77	5,10 3,96	4,72	5,57 4,22	5,24	5,57 4,39	5,92	5,57 4,66	5,92	5,57 4,66	5,92	5,57 4,66	5,92	5,57 4,66	5,92	5,57 4,66	5,92	5,57 4,66	5,92	5,57 4,66
SWD8.0X190	80	110	3,77	5,49 4,35	4,72	5,97 4,62	5,24	5,97 4,78	6,29	5,97 5,05	6,60	5,97 5,05	7,34	5,97 5,05	7,49	5,97 5,05	7,49	5,97 5,05	7,49	5,97 5,05	7,49	5,97 5,05
SWD8.0X220	95	125	3,77	5,88 4,43	4,72	6,36 5,01	5,24	6,36 5,17	6,29	6,36 5,44	6,60	6,36 5,44	7,34	6,36 5,44	7,86	6,36 5,44	8,38	6,36 5,44	9,07	6,36 5,44	9,07	6,36 5,44
SWD8.0X245	107	138	3,77	6,20 4,43	4,72	6,67 5,04	5,24	6,67 5,37	6,29	6,67 5,76	6,60	6,67 5,76	7,34	6,67 5,76	7,86	6,67 5,76	8,38	6,67 5,76	10,38	6,67 5,76	10,38	6,67 5,76
SWD8.0X275	107	168	3,77	6,20 4,43	4,72	6,67 5,04	5,24	6,67 5,37	6,29	6,67 5,76	6,60	6,67 5,76	7,34	6,67 5,76	7,86	6,67 5,76	8,38	6,67 5,76	10,38	6,67 5,76	10,38	6,67 5,76
SWD8.0X300	135	165	3,77	6,79 4,43	4,72	7,41 5,04	5,24	7,41 5,37	6,29	7,41 5,91	6,60	7,41 5,91	7,34	7,41 5,91	7,86	7,41 5,91	8,38	7,41 5,91	10,48	7,41 5,91	10,48	7,41 5,91
SWD8.0X330	135	195	3,77	6,79 4,43	4,72	7,41 5,04	5,24	7,41 5,37	6,29	7,41 5,91	6,60	7,41 5,91	7,34	7,41 5,91	7,86	7,41 5,91	8,38	7,41 5,91	10,48	7,41 5,91	10,48	7,41 5,91

For dimensions and calculation parameters see p. 50.

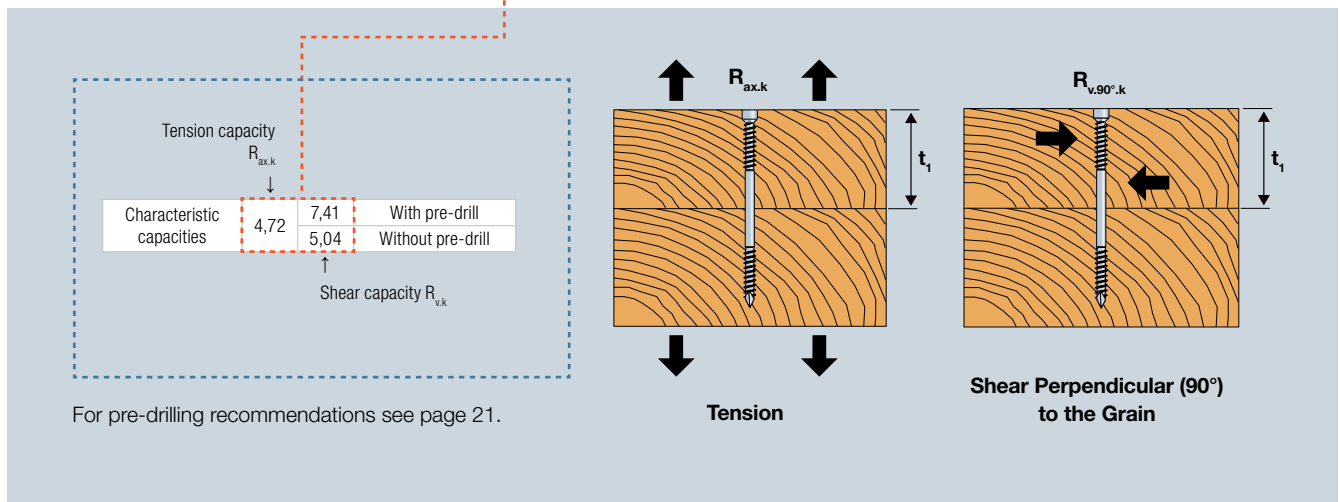

To ensure that the values in this catalog are valid, check that max. 5 mm of the thread is in the first element for partially threaded screws or that max. half the thread +/- 5 mm is in each element for the fully threaded screws.

For additional values in other configurations use Solid Wood – online dimensioning tool. Go to [solidwood.strongtie.eu](http://solidwood.strongtie.eu).

If the screw you are looking for is not shown in this table, it is because the screw cannot fulfil the requirements stated above. In this case, use Solid Wood to determine the capacity of the screw.

### 3.1 Solid Timber Fastening

#### SWD – Minimum Distances for Screws in Shear or Combined Loads<sup>1)</sup> Timber to Timber C24

Outer Thread Diameter d [mm]	Pre-drill	Angle Between Load Direction and Grain = 0°						Angle Between Load Direction and Grain = 90°					
		a <sub>1</sub>	a <sub>2</sub>	a <sub>3,c</sub>	a <sub>3,t</sub>	a <sub>4,c</sub>	a <sub>4,t</sub>	a <sub>1</sub>	a <sub>2</sub>	a <sub>3,c</sub>	a <sub>3,t</sub>	a <sub>4,c</sub>	a <sub>4,t</sub>
6.5	With pre-drill	33	20	46	78	20	20	26	26	46	33	20	46
	Without pre-drill	78	33	65	98	33	33	33	33	65	65	33	65
8.0	With pre-drill	40	24	56	96	24	24	32	32	56	40	24	56
	Without pre-drill	96	40	80	120	40	40	40	40	80	80	40	80

<sup>1)</sup> Minimum distances comply with EN 1995-1-1 (Eurocode 5) and ETA21/0670

<sup>2)</sup> Values given in the table is based on the  $\rho_k \leq 350 \text{ kg/m}^3$

<sup>3)</sup> Minimum distances from the unloaded edge perpendicular to the grain may be reduced to  $a_{4,c} = 3 \times d$  if the spacing parallel to the grain ( $a_1$ ) and the end distance ( $a_{3,t}$ ) is at least  $25 \times d$ .

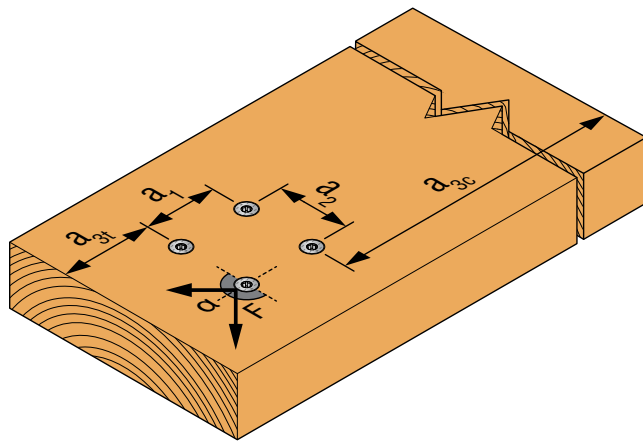

Illustration above shows angle between load direction and grain = 0°

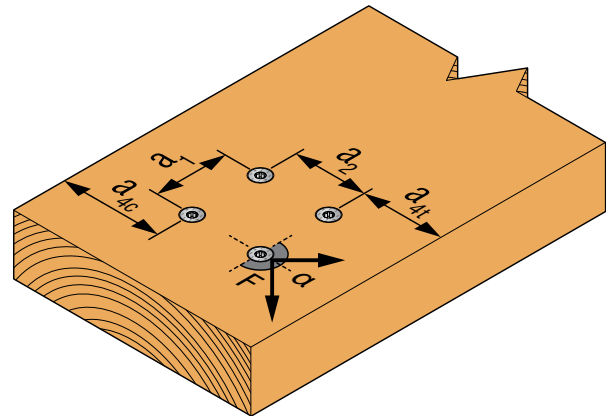

Illustration above shows angle between load direction and grain = 90°

See explanation of  $\alpha$  in General Introduction page 23.

#### SWD – Minimum Distances for Axially Loaded Screws Timber to Timber C24

Outer Thread Diameter d [mm]	a <sub>1</sub>	a <sub>2</sub>	a <sub>1,cg</sub>	a <sub>2,cg</sub>
6.5	65	20	52	20
8.0	80	24	64	24

\*Valid if the applied centre distances comply with  $a_1, a_2 \geq 25d^2$ . Calculation according to EN1995-1-1:2004+A2:2014.

For axially loaded screws installed perpendicular to the surface  $a_{3,t}$  and  $a_{4,t}$  are not relevant. For more info see General Introduction page 24.

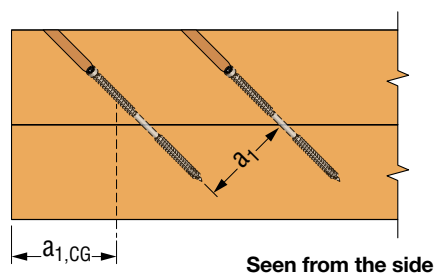

Seen from the side

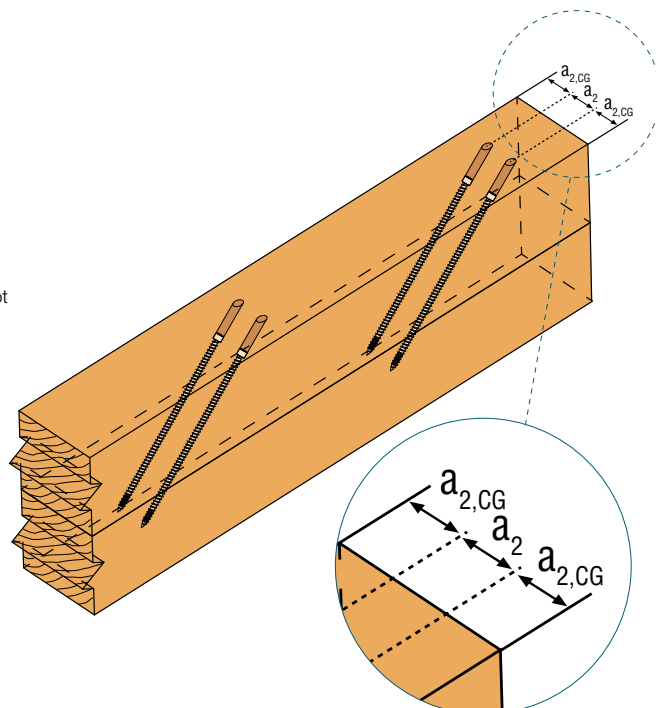

See explanation of min. space and edge distances in General Introduction page 24.



### 3.1 Solid Timber Fastening

## Solid-Drive™ SSH Structural Hex-Head WOOD Screw for Timber to Timber

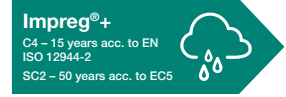

ETA-21/0670

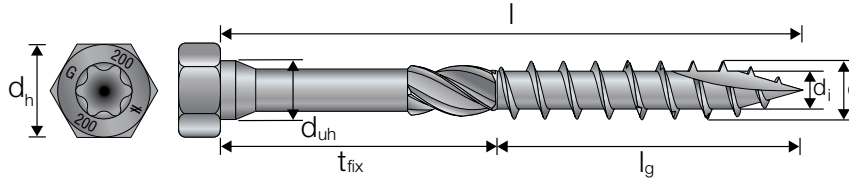

SSH – Characteristic Tension and Shear Capacities, Parallel (0°) to the Grain  
Timber to Timber C24

Product Reference	Thread Length L <sub>g</sub> [mm]	Max Advised Wood Thickness t <sub>1</sub> [mm]	Tension Capacity R <sub>ax,k</sub> and Shear Capacity R <sub>v,0°k</sub> Parallel to the Grain Depending on t <sub>1</sub> [kN]															
			Wood Thickness t <sub>1</sub> [mm]															
			36	45	50	60	63	70	75	80	100							
SSH6.0X75 <sup>1)</sup>	42	33	3,11	2,95	-	-	-	-	-	-	-	-	-	-	-	-	-	
				2,39	-	-	-	-	-	-	-	-	-	-	-	-	-	-
SSH6.0X90 <sup>1)</sup>	42	48	3,35	2,95	3,35	2,95	3,19	2,95	-	-	-	-	-	-	-	-	-	
				2,39	2,50	2,50	2,50	-	-	-	-	-	-	-	-	-	-	-
SSH6.0X120 <sup>1)</sup>	75	45	3,76	3,05	3,76	3,05	3,76	3,05	-	-	-	-	-	-	-	-	-	
				2,50	2,60	2,60	2,60	-	-	-	-	-	-	-	-	-	-	-
SSH8.0X80	42	38	3,30	4,18	-	-	-	-	-	-	-	-	-	-	-	-	-	
				2,88	-	-	-	-	-	-	-	-	-	-	-	-	-	-
SSH8.0X90	42	48	3,30	4,18	3,30	4,58	3,30	4,41	-	-	-	-	-	-	-	-	-	
				3,04	3,12	3,12	3,14	-	-	-	-	-	-	-	-	-	-	-
SSH8.0X100	55	45	3,30	4,18	3,30	4,58	3,30	4,58	-	-	-	-	-	-	-	-	-	
				3,04	3,31	3,31	3,37	-	-	-	-	-	-	-	-	-	-	-
SSH8.0X120	85	35	3,30	4,18	-	-	-	-	-	-	-	-	-	-	-	-	-	
				3,04	-	-	-	-	-	-	-	-	-	-	-	-	-	-
SSH8.0X140	85	55	3,30	4,18	3,30	4,58	3,30	4,58	3,30	4,58	-	-	-	-	-	-	-	
				3,04	3,31	3,31	3,48	3,30	3,69	-	-	-	-	-	-	-	-	-
SSH8.0X160	110	50	3,30	4,18	3,30	4,58	3,30	4,58	-	-	-	-	-	-	-	-	-	
				3,04	3,31	3,31	3,48	-	-	-	-	-	-	-	-	-	-	-
SSH8.0X180	110	70	3,30	4,18	3,30	4,58	3,30	4,58	3,30	4,58	3,30	4,58	3,30	4,58	-	-	-	
				3,04	3,31	3,31	3,48	3,30	3,69	3,30	3,69	3,30	3,69	3,30	3,69	-	-	-
SSH8.0X200	110	90	3,30	4,18	3,30	4,58	3,30	4,58	3,30	4,58	3,30	4,58	3,30	4,58	3,30	4,58	-	
				3,04	3,31	3,31	3,48	3,30	3,69	3,30	3,69	3,30	3,69	3,30	3,69	3,30	3,69	-
SSH8.0X240	110	130	3,30	4,18	3,30	4,58	3,30	4,58	3,30	4,58	3,30	4,58	3,30	4,58	3,30	4,58	3,30	
				3,04	3,31	3,31	3,48	3,30	3,69	3,30	3,69	3,30	3,69	3,30	3,69	3,30	3,69	3,30
SSH8.0X260	110	150	3,30	4,18	3,30	4,58	3,30	4,58	3,30	4,58	3,30	4,58	3,30	4,58	3,30	4,58	3,30	
				3,04	3,31	3,31	3,48	3,30	3,69	3,30	3,69	3,30	3,69	3,30	3,69	3,30	3,69	3,30
SSH8.0X280	110	170	3,30	4,18	3,30	4,58	3,30	4,58	3,30	4,58	3,30	4,58	3,30	4,58	3,30	4,58	3,30	
				3,04	3,31	3,31	3,48	3,30	3,69	3,30	3,69	3,30	3,69	3,30	3,69	3,30	3,69	3,30
SSH8.0X300	110	190	3,30	4,18	3,30	4,58	3,30	4,58	3,30	4,58	3,30	4,58	3,30	4,58	3,30	4,58	3,30	
				3,04	3,31	3,31	3,48	3,30	3,69	3,30	3,69	3,30	3,69	3,30	3,69	3,30	3,69	3,30

<sup>1)</sup> 6.0mm screws have a different head design – see page 52.

Table continues on next page.

### 3.1 Solid Timber Fastening

#### SSH – Characteristic Tension and Shear Capacities, Parallel (0°) to the Grain Timber to Timber C24 (continued)

Product Reference	Thread Length $L_g$ [mm]	Max Advised Wood Thickness $t_1$ [mm]	Tension Capacity $R_{ax,k}$ and Shear Capacity $R_{v,0^\circ,k}$ Parallel to the Grain Depending on $t_1$ [kN]																
			Wood Thickness $t_1$ [mm]																
			36	45	50	60	63	70	75	80	100	36	45	50	60	63	70	75	80
SSH10.0X90	42	48	-	-	4,34	5,90	4,34	5,65	-	-	-	-	-	-	-	-	-	-	-
			-	-	4,34	3,77	4,34	3,79	-	-	-	-	-	-	-	-	-	-	-
SSH10.0X100	55	45	-	-	4,34	6,01	4,34	6,23	-	-	-	-	-	-	-	-	-	-	-
			-	-	4,34	4,09	4,34	4,06	-	-	-	-	-	-	-	-	-	-	-
SSH10.0X140	85	55	-	-	4,34	6,01	4,34	6,23	4,34	6,23	-	-	-	-	-	-	-	-	-
			-	-	4,34	4,18	4,34	4,36	4,75	-	-	-	-	-	-	-	-	-	-
SSH10.0X160	110	50	-	-	4,34	6,01	4,34	6,23	-	-	-	-	-	-	-	-	-	-	-
			-	-	4,34	4,18	4,34	4,36	-	-	-	-	-	-	-	-	-	-	-
SSH10.0X180	110	70	-	-	4,34	6,01	4,34	6,23	4,34	6,23	4,34	6,23	4,34	6,23	4,34	6,23	-	-	-
			-	-	4,34	4,18	4,34	4,36	4,75	4,87	4,34	4,92	4,34	4,92	4,34	4,92	-	-	-
SSH10.0X200	110	90	-	-	4,34	6,01	4,34	6,23	4,34	6,23	4,34	6,23	4,34	6,23	4,34	6,23	4,34	6,23	-
			-	-	4,34	4,18	4,34	4,36	4,75	4,87	4,34	4,92	4,34	4,92	4,34	4,92	4,34	4,92	-
SSH10.0X220	125	95	-	-	4,34	6,01	4,34	6,23	4,34	6,23	4,34	6,23	4,34	6,23	4,34	6,23	4,34	6,23	4,34
			-	-	4,34	4,18	4,34	4,36	4,75	4,87	4,34	4,92	4,34	4,92	4,34	4,92	4,34	4,92	4,34
SSH10.0X240	125	115	-	-	4,34	6,01	4,34	6,23	4,34	6,23	4,34	6,23	4,34	6,23	4,34	6,23	4,34	6,23	4,34
			-	-	4,34	4,18	4,34	4,36	4,75	4,87	4,34	4,92	4,34	4,92	4,34	4,92	4,34	4,92	4,34
SSH10.0X280	125	155	-	-	4,34	6,01	4,34	6,23	4,34	6,23	4,34	6,23	4,34	6,23	4,34	6,23	4,34	6,23	4,34
			-	-	4,34	4,18	4,34	4,36	4,75	4,87	4,34	4,92	4,34	4,92	4,34	4,92	4,34	4,92	4,34

For dimensions and calculation parameters see p. 52.

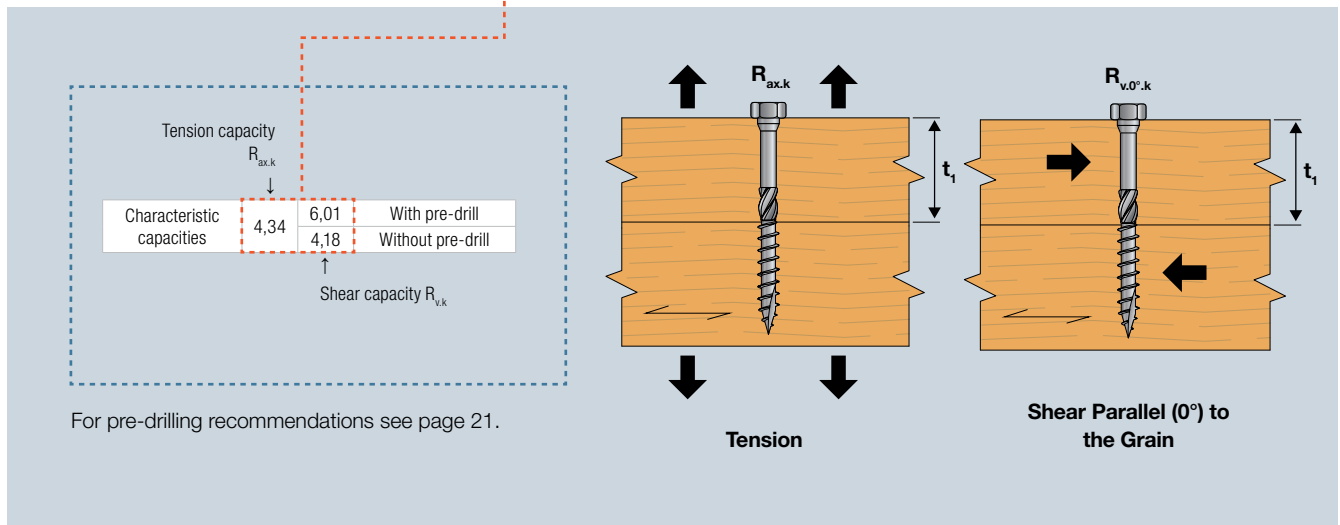

To ensure that the values in this catalog are valid, check that max. 5 mm of the thread is in the first element for partially threaded screws or that max. half the thread +/- 5 mm is in each element for the fully threaded screws.

For additional values in other configurations use Solid Wood – online dimensioning tool. Go to [solidwood.strongtie.eu](http://solidwood.strongtie.eu).

If the screw you are looking for is not shown in this table, it is because the screw cannot fulfil the requirements stated above. In this case, use Solid Wood to determine the capacity of the screw.

### 3.1 Solid Timber Fastening

#### SSH – Characteristic Tension and Shear Capacities, Perpendicular (90°) to the Grain Timber to Timber C24

Product Reference	Thread Length $L_g$ [mm]	Max Advised Wood Thickness $t_f$ [mm]	Tension Capacity $R_{ax,k}$ and Shear Capacity $R_{v,90^\circ,k}$ Perpendicular to the Grain Depending on $t_f$ [kN]																																	
			Wood Thickness $t_f$ [mm]																																	
			36	45	50	60	63	70	75	80	100	36	45	50	60	63	70	75	80	100																
SSH6.0X75	42	33	3,11	2,95	-	-	-	-	-	-	-	-	-	-	-	-	-	-	-	2,39	-	-	-	-	-	-	-	-	-	-	-	-	-	-	-	-
				2,95	3,35	2,95	3,19	2,95	-	-	-	-	-	-	-	-	-	-	-	-	-	-	2,39	2,50	2,50	2,50	-	-	-	-	-	-	-	-	-	-
SSH6.0X90	42	48	3,35	3,05	3,76	3,05	3,76	3,05	-	-	-	-	-	-	-	-	-	-	-	2,50	3,76	2,60	3,76	3,05	-	-	-	-	-	-	-	-	-	-	-	-
				4,18	-	-	-	-	-	-	-	-	-	-	-	-	-	-	-	-	-	-	2,88	-	-	-	-	-	-	-	-	-	-	-	-	-
SSH8.0X80	42	38	3,30	4,18	3,30	4,58	3,30	4,41	-	-	-	-	-	-	-	-	-	-	-	3,04	3,30	3,12	3,14	-	-	-	-	-	-	-	-	-	-	-	-	-
				4,18	3,30	4,58	3,30	4,58	-	-	-	-	-	-	-	-	-	-	-	-	-	-	3,04	3,30	3,31	3,30	4,58	-	-	-	-	-	-	-	-	-
SSH8.0X90	42	48	3,30	4,18	-	-	-	-	-	-	-	-	-	-	-	-	-	-	-	3,04	-	-	-	-	-	-	-	-	-	-	-	-	-	-	-	-
				4,18	3,30	4,58	3,30	4,58	-	-	-	-	-	-	-	-	-	-	-	-	-	-	3,04	3,30	3,31	3,30	4,58	-	-	-	-	-	-	-	-	-
SSH8.0X100	55	45	3,30	4,18	-	-	-	-	-	-	-	-	-	-	-	-	-	-	-	3,04	-	-	-	-	-	-	-	-	-	-	-	-	-	-	-	-
				4,18	3,30	4,58	3,30	4,58	-	-	-	-	-	-	-	-	-	-	-	-	-	-	3,04	3,30	3,31	3,30	4,58	-	-	-	-	-	-	-	-	-
SSH8.0X120	85	35	3,30	4,18	-	-	-	-	-	-	-	-	-	-	-	-	-	-	-	3,04	-	-	-	-	-	-	-	-	-	-	-	-	-	-	-	-
				4,18	3,30	4,58	3,30	4,58	3,30	4,58	3,30	4,58	-	-	-	-	-	-	-	-	-	-	3,04	3,30	3,31	3,30	4,58	3,30	4,58	-	-	-	-	-	-	-
SSH8.0X140	85	55	3,30	4,18	3,30	4,58	3,30	4,58	3,30	4,58	3,30	4,58	3,30	4,58	3,30	4,58	3,30	4,58	3,30	3,04	3,30	3,31	3,30	4,58	3,30	4,58	3,30	4,58	3,30	4,58	3,30	4,58	3,30	4,58	3,30	
				4,18	3,30	4,58	3,30	4,58	3,30	4,58	3,30	4,58	3,30	4,58	3,30	4,58	3,30	4,58	3,30	4,58	3,30	4,58	3,04	3,30	3,31	3,30	4,58	3,30	4,58	3,30	4,58	3,30	4,58	3,30	4,58	3,30
SSH8.0X160	110	50	3,30	4,18	3,30	4,58	3,30	4,58	3,30	4,58	3,30	4,58	3,30	4,58	3,30	4,58	3,30	4,58	3,30	3,04	3,30	3,31	3,30	4,58	3,30	4,58	3,30	4,58	3,30	4,58	3,30	4,58	3,30	4,58	3,30	
				4,18	3,30	4,58	3,30	4,58	3,30	4,58	3,30	4,58	3,30	4,58	3,30	4,58	3,30	4,58	3,30	4,58	3,30	4,58	3,04	3,30	3,31	3,30	4,58	3,30	4,58	3,30	4,58	3,30	4,58	3,30	4,58	3,30
SSH8.0X180	110	70	3,30	4,18	3,30	4,58	3,30	4,58	3,30	4,58	3,30	4,58	3,30	4,58	3,30	4,58	3,30	4,58	3,30	3,04	3,30	3,31	3,30	4,58	3,30	4,58	3,30	4,58	3,30	4,58	3,30	4,58	3,30	4,58	3,30	4,58
				4,18	3,30	4,58	3,30	4,58	3,30	4,58	3,30	4,58	3,30	4,58	3,30	4,58	3,30	4,58	3,30	4,58	3,30	4,58	3,04	3,30	3,31	3,30	4,58	3,30	4,58	3,30	4,58	3,30	4,58	3,30	4,58	3,30
SSH8.0X200	110	90	3,30	4,18	3,30	4,58	3,30	4,58	3,30	4,58	3,30	4,58	3,30	4,58	3,30	4,58	3,30	4,58	3,30	3,04	3,30	3,31	3,30	4,58	3,30	4,58	3,30	4,58	3,30	4,58	3,30	4,58	3,30	4,58	3,30	4,58
				4,18	3,30	4,58	3,30	4,58	3,30	4,58	3,30	4,58	3,30	4,58	3,30	4,58	3,30	4,58	3,30	4,58	3,30	4,58	3,04	3,30	3,31	3,30	4,58	3,30	4,58	3,30	4,58	3,30	4,58	3,30	4,58	3,30
SSH8.0X240	110	130	3,30	4,18	3,30	4,58	3,30	4,58	3,30	4,58	3,30	4,58	3,30	4,58	3,30	4,58	3,30	4,58	3,30	3,04	3,30	3,31	3,30	4,58	3,30	4,58	3,30	4,58	3,30	4,58	3,30	4,58	3,30	4,58	3,30	4,58
				4,18	3,30	4,58	3,30	4,58	3,30	4,58	3,30	4,58	3,30	4,58	3,30	4,58	3,30	4,58	3,30	4,58	3,30	4,58	3,04	3,30	3,31	3,30	4,58	3,30	4,58	3,30	4,58	3,30	4,58	3,30	4,58	3,30
SSH8.0X260	110	150	3,30	4,18	3,30	4,58	3,30	4,58	3,30	4,58	3,30	4,58	3,30	4,58	3,30	4,58	3,30	4,58	3,30	3,04	3,30	3,31	3,30	4,58	3,30	4,58	3,30	4,58	3,30	4,58	3,30	4,58	3,30	4,58	3,30	4,58
				4,18	3,30	4,58	3,30	4,58	3,30	4,58	3,30	4,58	3,30	4,58	3,30	4,58	3,30	4,58	3,30	4,58	3,30	4,58	3,04	3,30	3,31	3,30	4,58	3,30	4,58	3,30	4,58	3,30	4,58	3,30	4,58	3,30
SSH8.0X280	110	170	3,30	4,18	3,30	4,58	3,30	4,58	3,30	4,58	3,30	4,58	3,30	4,58	3,30	4,58	3,30	4,58	3,30	3,04	3,30	3,31	3,30	4,58	3,30	4,58	3,30	4,58	3,30	4,58	3,30	4,58	3,30	4,58	3,30	4,58
				4,18	3,30	4,58	3,30	4,58	3,30	4,58	3,30	4,58	3,30	4,58	3,30	4,58	3,30	4,58	3,30	4,58	3,30	4,58	3,04	3,30	3,31	3,30	4,58	3,30	4,58	3,30	4,58	3,30	4,58	3,30	4,58	3,30
SSH8.0X300	110	190	3,30	4,18	3,30	4,58	3,30	4,58	3,30	4,58	3,30	4,58	3,30	4,58	3,30	4,58	3,30	4,58	3,30	3,04	3,30	3,31	3,30	4,58	3,30	4,58	3,30	4,58	3,30	4,58	3,30	4,58	3,30	4,58	3,30	4,58
				4,18	3,30	4,58	3,30	4,58	3,30	4,58	3,30	4,58	3,30	4,58	3,30	4,58	3,30	4,58	3,30	4,58	3,30	4,58	3,04	3,30	3,31	3,30	4,58	3,30	4,58	3,30	4,58	3,30	4,58	3,30	4,58	3,30

Table continues on next page.

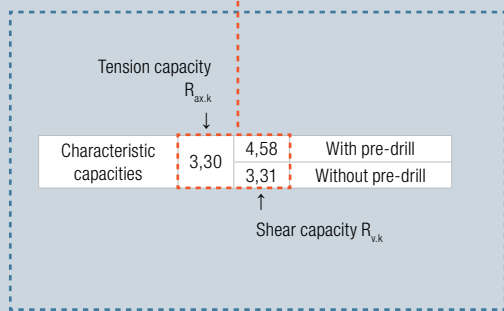

For pre-drilling recommendations see page 21.

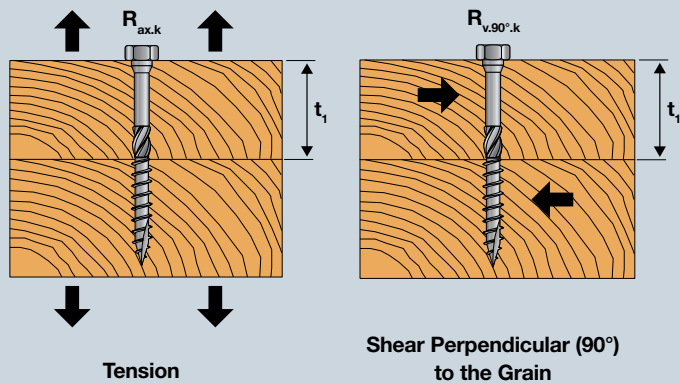

### 3.1 Solid Timber Fastening

#### SSH – Characteristic Tension and Shear Capacities, Perpendicular (90°) to the Grain Timber to Timber C24 (continued)

Product Reference	Thread Length $L_g$ [mm]	Max Advised Wood Thickness $t_1$ [mm]	Tension Capacity $R_{ax,k}$ and Shear Capacity $R_{v,90^\circ,k}$ Perpendicular to the Grain Depending on $t_1$ [kN]																	
			Wood Thickness $t_1$ [mm]																	
			36		45		50		60		63		70		75		80		100	
SSH10.0X90	42	48	-	-	4,34	5,90	4,34	5,65	-	-	-	-	-	-	-	-	-	-	-	-
			-	-		3,77		3,79	-	-	-	-	-	-	-	-	-	-	-	-
SSH10.0X100	55	45	-	-	4,34	6,01	4,34	6,23	-	-	-	-	-	-	-	-	-	-	-	-
			-	-		4,09		4,06	-	-	-	-	-	-	-	-	-	-	-	-
SSH10.0X140	85	55	-	-	4,34	6,01	4,34	6,23	4,34	6,23	-	-	-	-	-	-	-	-	-	-
			-	-		4,18		4,36		4,75	-	-	-	-	-	-	-	-	-	-
SSH10.0X160	110	50	-	-	4,34	6,01	4,34	6,23	-	-	-	-	-	-	-	-	-	-	-	-
			-	-		4,18		4,36	-	-	-	-	-	-	-	-	-	-	-	-
SSH10.0X180	110	70	-	-	4,34	6,01	4,34	6,23	4,34	6,23	4,34	6,23	4,34	6,23	4,34	6,23	-	-	-	-
			-	-		4,18		4,36		4,75		4,87		4,92		4,92	-	-	-	-
SSH10.0X200	110	90	-	-	4,34	6,01	4,34	6,23	4,34	6,23	4,34	6,23	4,34	6,23	4,34	6,23	4,34	6,23	-	-
			-	-		4,18		4,36		4,75		4,87		4,92		4,92	4,34	6,23	4,34	6,23
SSH10.0X220	125	95	-	-	4,34	6,01	4,34	6,23	4,34	6,23	4,34	6,23	4,34	6,23	4,34	6,23	4,34	6,23	4,34	6,23
			-	-		4,18		4,36		4,75		4,87		4,92		4,92	4,34	6,23	4,34	6,23
SSH10.0X240	125	115	-	-	4,34	6,01	4,34	6,23	4,34	6,23	4,34	6,23	4,34	6,23	4,34	6,23	4,34	6,23	4,34	6,23
			-	-		4,18		4,36		4,75		4,87		4,92		4,92	4,34	6,23	4,34	6,23
SSH10.0X280	125	155	-	-	4,34	6,01	4,34	6,23	4,34	6,23	4,34	6,23	4,34	6,23	4,34	6,23	4,34	6,23	4,34	6,23
			-	-		4,18		4,36		4,75		4,87		4,92		4,92	4,34	6,23	4,34	6,23

For dimensions and calculation parameters see p. 52.

Timber to Timber Fastening

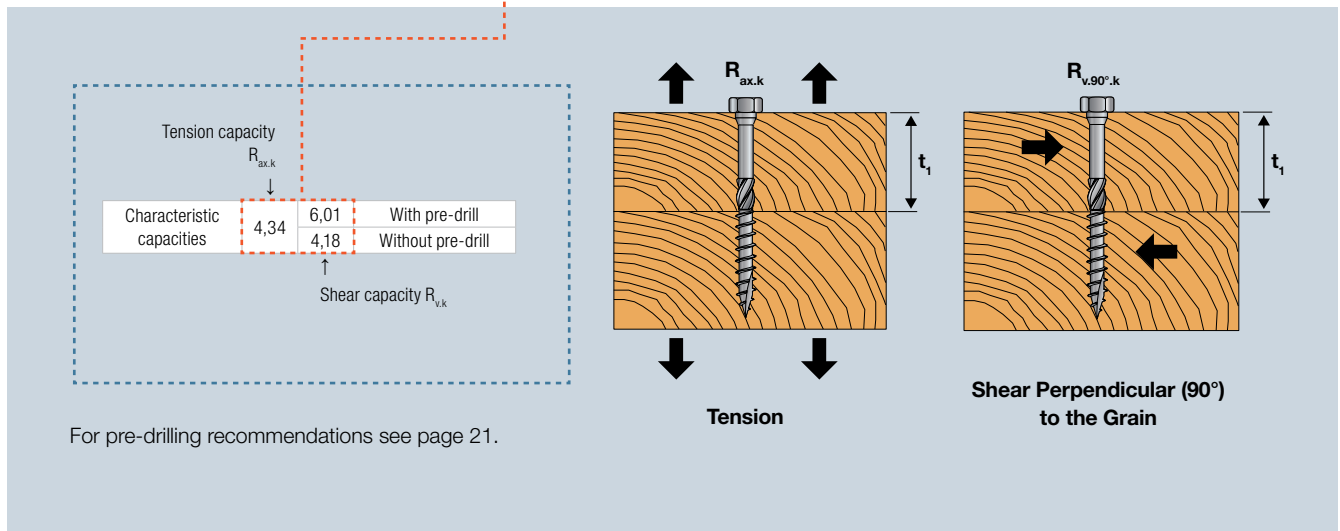

To ensure that the values in this catalog are valid, check that max. 5 mm of the thread is in the first element for partially threaded screws or that max. half the thread +/- 5 mm is in each element for the fully threaded screws.

For additional values in other configurations use Solid Wood – online dimensioning tool. Go to [solidwood.strongtie.eu](http://solidwood.strongtie.eu).

If the screw you are looking for is not shown in this table, it is because the screw cannot fulfil the requirements stated above. In this case, use Solid Wood to determine the capacity of the screw.

### 3.1 Solid Timber Fastening

#### SSH – Minimum Distances for Screws in Shear or Combined Loads<sup>1)</sup> Timber to Timber C24

Outer Thread Diameter d [mm]	Pre-drill	Angle Between Load Direction and Grain = 0°						Angle Between Load Direction and Grain = 90°					
		a <sub>1</sub>	a <sub>2</sub>	a <sub>3,c</sub>	a <sub>3,t</sub>	a <sub>4,c</sub>	a <sub>4,t</sub>	a <sub>1</sub>	a <sub>2</sub>	a <sub>3,c</sub>	a <sub>3,t</sub>	a <sub>4,c</sub>	a <sub>4,t</sub>
6.0	With pre-drill	30	18	42	72	18	18	24	24	42	30	18	42
	Without pre-drill	72	30	60	90	30	30	30	30	60	60	30	60
8.0	With pre-drill	40	24	56	96	24	24	32	32	56	40	24	56
	Without pre-drill	96	40	80	120	40	40	40	40	80	80	40	80
10.0	With pre-drill	50	30	70	120	30	30	40	40	70	50	30	70
	Without pre-drill	120	50	100	150	50	50	50	50	100	100	50	100
12.0	With pre-drill	60	36	84	144	36	36	48	48	84	60	36	84
	Without pre-drill	144	60	120	180	60	60	60	60	120	120	60	120

<sup>1)</sup> Minimum distances comply with EN 1995-1-1 (Eurocode 5) and ETA21/0670

<sup>2)</sup> Values given in the table is based on the  $\rho_k \leq 350 \text{ kg/m}^3$

<sup>3)</sup> Minimum distances from the unloaded edge perpendicular to the grain may be reduced to  $a_{4,c} = 3 \times d$  if the spacing parallel to the grain ( $a_1$ ) and the end distance ( $a_{3,t}$ ) is at least  $25 \times d$ .

#### SSH – Minimum Distances for Axially Loaded Screws Timber to Timber C24

Outer Thread Diameter d [mm]	a <sub>1</sub>	a <sub>2</sub>	a <sub>3,c</sub>	a <sub>4,c</sub>
6.0	42	30	60	24
8.0	56	40	80	32
10.0	70	50	100	40
12.0	84	60	120	48

\*Valid if the applied centre distances comply with  $a_1, a_2 \geq 25d^2$ .  
Calculation according to EN1995-1-1:2004+A2:2014.

For axially loaded screws installed perpendicular to the surface  $a_{3,t}$  and  $a_{4,t}$  are not relevant. For more info see General Introduction page 24.

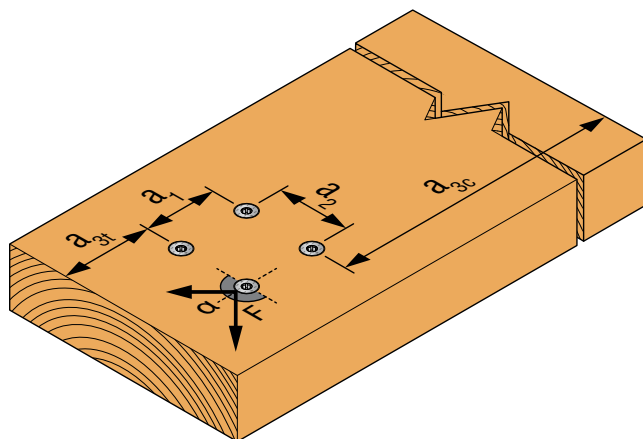

Illustration above shows angle between load direction and grain = 0°

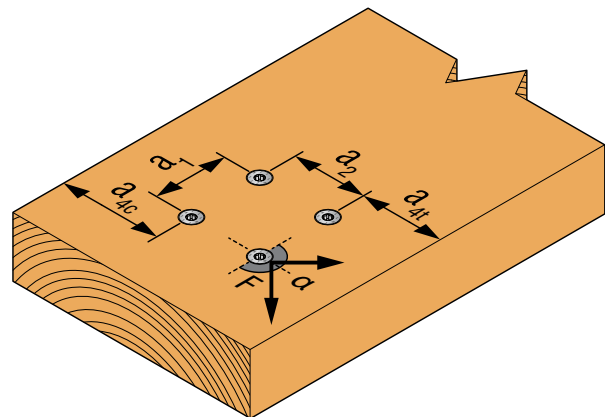

Illustration above shows angle between load direction and grain = 90°

See explanation of  $\alpha$  in General Introduction page 23.

### 3.1 Solid Timber Fastening

## Solid-Drive™ ESCRFTC Full Threaded WOOD Screw for Timber to Timber

Yellow Zinc Plated  
C2 acc. to EN ISO 12944-2  
SC2 – 50 years acc. to EC5

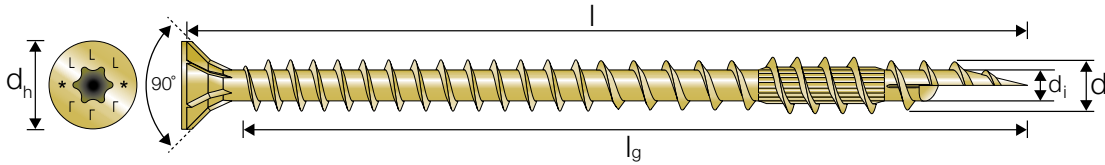

### ESCRFTC – Characteristic Tension and Shear Capacities, Parallel (0°) to the Grain Timber to Timber C24

Product Reference	Thread Length $L_s$ [mm]	Tension Capacity $R_{ax,k}$ and Shear Capacity $R_{v,0^\circ,k}$ Parallel to the Grain Depending on $t_1$ [kN]																	
		Wood Thickness $t_1$ [mm]																	
		36		45		50		60		63		70		75		80		100	
ESCRFTC8.0X120	110	2,72	4,53 3,40	3,67	4,68 3,70	4,19	4,68 3,87	5,24	4,68 3,88	5,55	4,68 3,87	5,24	4,68 3,87	4,72	4,68 3,70	4,19	4,68 3,53	-	-
ESCRFTC8.0X140	130	2,72	4,80 3,67	3,67	4,94 3,96	4,19	4,94 4,13	5,24	4,94 4,14	5,55	4,94 4,14	6,29	4,94 4,14	6,81	4,94 4,14	6,29	4,94 4,14	4,19	4,94 3,79
ESCRFTC8.0X160	150	2,72	5,06 3,93	3,67	5,20 4,22	4,19	5,20 4,39	5,24	5,20 4,40	5,55	5,20 4,40	6,29	5,20 4,40	6,81	5,20 4,40	7,34	5,20 4,40	6,29	5,20 4,40
ESCRFTC8.0X180	170	2,72	5,32 4,19	3,67	5,46 4,48	4,19	5,46 4,66	5,24	5,46 4,67	5,55	5,46 4,67	6,29	5,46 4,67	6,81	5,46 4,67	7,34	5,46 4,67	8,38	5,46 4,67
ESCRFTC8.0X200	190	2,72	5,58 4,19	3,67	5,73 4,74	4,19	5,73 4,92	5,24	5,73 4,93	5,55	5,73 4,93	6,29	5,73 4,93	6,81	5,73 4,93	7,34	5,73 4,93	9,43	5,73 4,93
ESCRFTC8.0X220	210	2,72	5,84 4,19	3,67	5,99 4,77	4,19	5,99 5,12	5,24	5,99 5,14	5,55	5,99 5,14	6,29	5,99 5,14	6,81	5,99 5,14	7,34	5,99 5,14	9,43	5,99 5,14
ESCRFTC8.0X240	230	2,72	6,11 4,19	3,67	6,25 4,77	4,19	6,25 5,12	5,24	6,25 5,14	5,55	6,25 5,14	6,29	6,25 5,14	6,81	6,25 5,14	7,34	6,25 5,14	9,43	6,25 5,14
ESCRFTC8.0X260	250	2,72	6,37 4,19	3,67	6,51 4,77	4,19	6,51 5,12	5,24	6,51 5,14	5,55	6,51 5,14	6,29	6,51 5,14	6,81	6,51 5,14	7,34	6,51 5,14	9,43	6,51 5,14
ESCRFTC8.0X280	270	2,72	6,45 4,19	3,67	6,74 4,77	4,19	6,74 5,12	5,24	6,74 5,14	5,55	6,74 5,14	6,29	6,74 5,14	6,81	6,74 5,14	7,34	6,74 5,14	9,43	6,74 5,14
ESCRFTC8.0X300	290	2,72	6,45 4,19	3,67	6,74 4,77	4,19	6,74 5,12	5,24	6,74 5,14	5,55	6,74 5,14	6,29	6,74 5,14	6,81	6,74 5,14	7,34	6,74 5,14	9,43	6,74 5,14
ESCRFTC8.0X350	340	2,72	6,45 4,19	3,67	6,74 4,77	4,19	6,74 5,12	5,24	6,74 5,14	5,55	6,74 5,14	6,29	6,74 5,14	6,81	6,74 5,14	7,34	6,74 5,14	9,43	6,74 5,14
ESCRFTC8.0X400	390	2,72	6,45 4,19	3,67	6,74 4,77	4,19	6,74 5,12	5,24	6,74 5,14	5,55	6,74 5,14	6,29	6,74 5,14	6,81	6,74 5,14	7,34	6,74 5,14	9,43	6,74 5,14
ESCRFTC8.0X450	427	1,36	6,45 4,19	2,31	6,74 4,77	2,83	6,74 5,12	3,88	6,74 5,14	4,19	6,74 5,14	4,93	6,74 5,14	5,45	6,74 5,14	5,97	6,74 5,14	8,07	6,74 5,14

Table continues on next page.

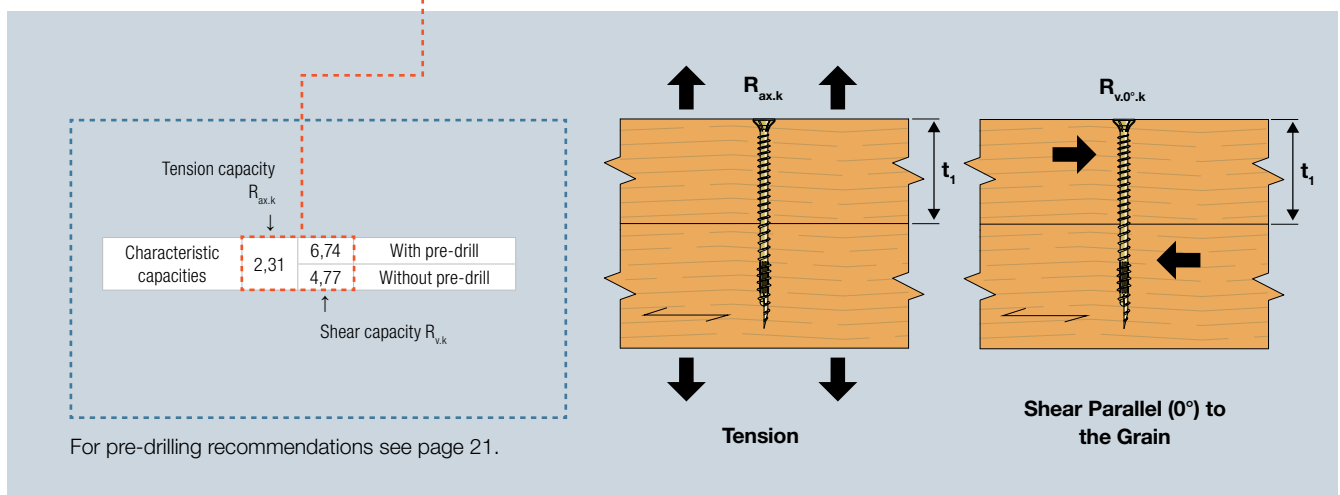



### 3.1 Solid Timber Fastening

#### ESCRFTC – Characteristic Tension and Shear Capacities, Parallel (0°) to the Grain Timber to Timber C24 (continued)

Product Reference	Thread Length $L_y$ [mm]	Tension Capacity $R_{ax,k}$ and Shear Capacity $R_{v,0^\circ,k}$ Parallel to the Grain Depending on $t_t$ [kN]																	
		Wood Thickness $t_t$ [mm]																	
		36		45		50		60		63		70		75		80		100	
ESCRFTC10.0X120	108	-	-	4,13	6,35	4,75	6,48	6,00	6,48	6,38	6,48	6,25	6,48	5,63	6,35	5,00	5,99	-	-
ESCRFTC10.0X160	148	-	-	4,13	6,98	4,75	7,10	6,00	7,10	6,38	7,10	7,25	7,10	7,88	7,10	8,50	7,10	7,50	7,10
ESCRFTC10.0X180	168	-	-	4,13	7,29	4,75	7,41	6,00	7,41	6,38	7,41	7,25	7,41	7,88	7,41	8,50	7,41	10,00	7,41
ESCRFTC10.0X200	188	-	-	4,13	7,60	4,75	7,73	6,00	7,73	6,38	7,73	7,25	7,73	7,88	7,73	8,50	7,73	11,00	7,73
ESCRFTC10.0X220	208	-	-	4,13	7,91	4,75	8,04	6,00	8,04	6,38	8,04	7,25	8,04	7,88	8,04	8,50	8,04	11,00	8,04
ESCRFTC10.0X240	228	-	-	4,13	8,23	4,75	8,35	6,00	8,35	6,38	8,35	7,25	8,35	7,88	8,35	8,50	8,35	11,00	8,35
ESCRFTC10.0X260	248	-	-	4,13	8,54	4,75	8,66	6,00	8,66	6,38	8,66	7,25	8,66	7,88	8,66	8,50	8,66	11,00	8,66
ESCRFTC10.0X280	268	-	-	4,13	8,85	4,75	8,98	6,00	8,98	6,38	8,98	7,25	8,98	7,88	8,98	8,50	8,98	11,00	8,98
ESCRFTC10.0X300	288	-	-	4,13	9,16	4,75	9,29	6,00	9,29	6,38	9,29	7,25	9,29	7,88	9,29	8,50	9,29	11,00	9,29
ESCRFTC10.0X350	338	-	-	4,13	9,77	4,75	10,01	6,00	10,01	6,38	10,01	7,25	10,01	7,88	10,01	8,50	10,01	11,00	10,01
ESCRFTC10.0X400	376	-	-	2,63	9,77	3,25	10,01	4,50	10,01	4,88	10,01	5,75	10,01	6,38	10,01	7,00	10,01	9,50	10,01
ESCRFTC10.0X450	426	-	-	2,63	9,77	3,25	10,01	4,50	10,01	4,88	10,01	5,75	10,01	6,38	10,01	7,00	10,01	9,50	10,01
ESCRFTC12.0X200	180	-	-	-	-	-	-	-	-	-	-	-	-	-	-	8,06	8,76	10,75	8,76
ESCRFTC12.0X220	200	-	-	-	-	-	-	-	-	-	-	-	-	-	-	8,06	9,09	10,75	9,09
ESCRFTC12.0X240	220	-	-	-	-	-	-	-	-	-	-	-	-	-	-	8,06	9,43	10,75	9,43
ESCRFTC12.0X260	240	-	-	-	-	-	-	-	-	-	-	-	-	-	-	8,06	9,76	10,75	9,76
ESCRFTC12.0X280	260	-	-	-	-	-	-	-	-	-	-	-	-	-	-	8,06	10,10	10,75	10,10
ESCRFTC12.0X300	280	-	-	-	-	-	-	-	-	-	-	-	-	-	-	8,06	10,44	10,75	10,44
ESCRFTC12.0X350	330	-	-	-	-	-	-	-	-	-	-	-	-	-	-	8,06	11,28	10,75	11,28
ESCRFTC12.0X400	380	-	-	-	-	-	-	-	-	-	-	-	-	-	-	8,06	12,12	10,75	12,12
ESCRFTC12.0X450	430	-	-	-	-	-	-	-	-	-	-	-	-	-	-	8,06	12,47	10,75	12,47
ESCRFTC12.0X500	480	-	-	-	-	-	-	-	-	-	-	-	-	-	-	8,06	12,47	10,75	12,47
ESCRFTC12.0X600	580	-	-	-	-	-	-	-	-	-	-	-	-	-	-	8,06	12,47	10,75	12,47

For dimensions and calculation parameters see p. 56.

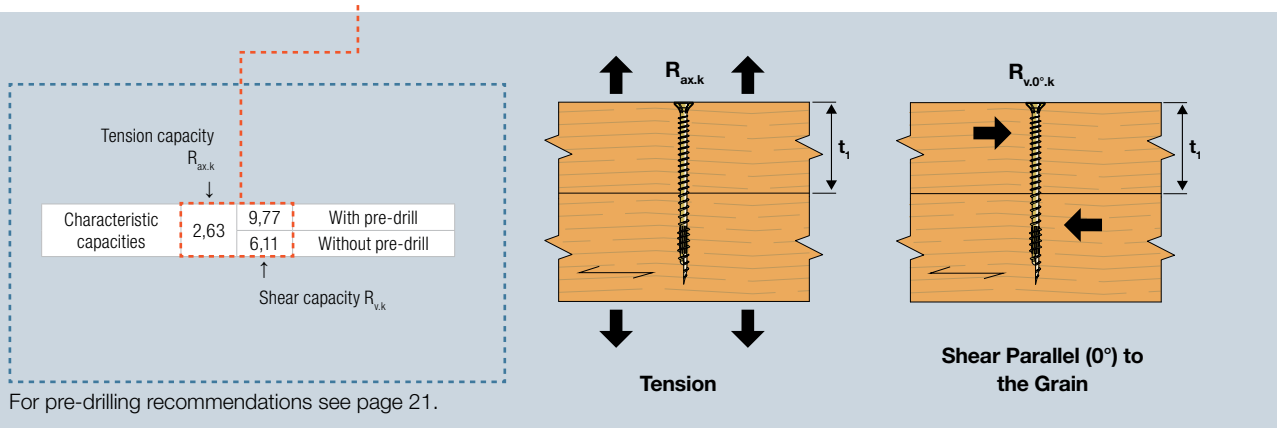

C-F-EU-TG-2023-2 (2<sup>nd</sup> Edition) © 2023 SIMPSON STRONG-TIE COMPANY INC.

Timber to Timber Fastening

### 3.1 Solid Timber Fastening

ESCRFTC – Characteristic Tension and Shear Capacities, Perpendicular (90°) to the Grain Timber to Timber C24

Product Reference	Thread Length $L_y$ [mm]	Tension and Shear Capacity $R_{v,90^\circ,k}$ Perpendicular to the Grain Depending on $t_1$ [kN]																	
		Wood Thickness $t_1$ [mm]																	
		36		45		50		60		63		70		75		80		100	
ESCRFTC8.0X120	110	2,72	4,53 3,40	3,67	4,68 3,70	4,19	4,68 3,87	5,24	4,68 3,88	5,55	4,68 3,88	5,24	4,68 3,87	4,72	4,68 3,70	4,19	4,68 3,53	-	-
ESCRFTC8.0X140	130	2,72	4,80 3,67	3,67	4,94 3,96	4,19	4,94 4,13	5,24	4,94 4,14	5,55	4,94 4,14	6,29	4,94 4,14	6,81	4,94 4,14	6,29	4,94 4,14	4,19	4,94 3,79
ESCRFTC8.0X160	150	2,72	5,06 3,93	3,67	5,20 4,22	4,19	5,20 4,39	5,24	5,20 4,40	5,55	5,20 4,40	6,29	5,20 4,40	6,81	5,20 4,40	7,34	5,20 4,40	6,29	5,20 4,40
ESCRFTC8.0X180	170	2,72	5,32 4,19	3,67	5,46 4,48	4,19	5,46 4,66	5,24	5,46 4,67	5,55	5,46 4,67	6,29	5,46 4,67	6,81	5,46 4,67	7,34	5,46 4,67	8,38	5,46 4,67
ESCRFTC8.0X200	190	2,72	5,58 4,19	3,67	5,73 4,74	4,19	5,73 4,92	5,24	5,73 4,93	5,55	5,73 4,93	6,29	5,73 4,93	6,81	5,73 4,93	7,34	5,73 4,93	9,43	5,73 4,93
ESCRFTC8.0X220	210	2,72	5,84 4,19	3,67	5,99 4,77	4,19	5,99 5,12	5,24	5,99 5,14	5,55	5,99 5,14	6,29	5,99 5,14	6,81	5,99 5,14	7,34	5,99 5,14	9,43	5,99 5,14
ESCRFTC8.0X240	230	2,72	6,11 4,19	3,67	6,25 4,77	4,19	6,25 5,12	5,24	6,25 5,14	5,55	6,25 5,14	6,29	6,25 5,14	6,81	6,25 5,14	7,34	6,25 5,14	9,43	6,25 5,14
ESCRFTC8.0X260	250	2,72	6,37 4,19	3,67	6,51 4,77	4,19	6,51 5,12	5,24	6,51 5,14	5,55	6,51 5,14	6,29	6,51 5,14	6,81	6,51 5,14	7,34	6,51 5,14	9,43	6,51 5,14
ESCRFTC8.0X280	270	2,72	6,45 4,19	3,67	6,74 4,77	4,19	6,74 5,12	5,24	6,74 5,14	5,55	6,74 5,14	6,29	6,74 5,14	6,81	6,74 5,14	7,34	6,74 5,14	9,43	6,74 5,14
ESCRFTC8.0X300	290	2,72	6,45 4,19	3,67	6,74 4,77	4,19	6,74 5,12	5,24	6,74 5,14	5,55	6,74 5,14	6,29	6,74 5,14	6,81	6,74 5,14	7,34	6,74 5,14	9,43	6,74 5,14
ESCRFTC8.0X350	340	2,72	6,45 4,19	3,67	6,74 4,77	4,19	6,74 5,12	5,24	6,74 5,14	5,55	6,74 5,14	6,29	6,74 5,14	6,81	6,74 5,14	7,34	6,74 5,14	9,43	6,74 5,14
ESCRFTC8.0X400	390	2,72	6,45 4,19	3,67	6,74 4,77	4,19	6,74 5,12	5,24	6,74 5,14	5,55	6,74 5,14	6,29	6,74 5,14	6,81	6,74 5,14	7,34	6,74 5,14	9,43	6,74 5,14
ESCRFTC8.0X450	427	1,36	6,45 4,19	2,31	6,74 4,77	2,83	6,74 5,12	3,88	6,74 5,14	4,19	6,74 5,14	4,93	6,74 5,14	5,45	6,74 5,14	5,97	6,74 5,14	8,07	6,74 5,14
ESCRFTC10.0X120	108	-	-	4,13	6,35 4,52	4,75	6,48 4,71	6,00	6,48 5,04	6,38	6,48 4,98	6,25	6,48 4,71	5,63	6,35 4,52	5,00	5,99 4,35	-	-
ESCRFTC10.0X160	148	-	-	4,13	6,98 5,15	4,75	7,10 5,33	6,00	7,10 5,73	6,38	7,10 5,83	7,25	7,10 5,83	7,88	7,10 5,83	8,50	7,10 5,83	7,50	7,10 5,73
ESCRFTC10.0X180	168	-	-	4,13	7,29 5,46	4,75	7,41 5,64	6,00	7,41 6,04	6,38	7,41 6,14	7,25	7,41 6,14	7,88	7,41 6,14	8,50	7,41 6,14	10,00	7,41 6,14
ESCRFTC10.0X200	188	-	-	4,13	7,60 5,77	4,75	7,73 5,96	6,00	7,73 6,35	6,38	7,73 6,46	7,25	7,73 6,46	7,88	7,73 6,46	8,50	7,73 6,46	11,00	7,73 6,46
ESCRFTC10.0X220	208	-	-	4,13	7,91 6,08	4,75	8,04 6,27	6,00	8,04 6,66	6,38	8,04 6,77	7,25	8,04 6,77	7,88	8,04 6,77	8,50	8,04 6,77	11,00	8,04 6,77
ESCRFTC10.0X240	228	-	-	4,13	8,23 6,11	4,75	8,35 6,47	6,00	8,35 6,98	6,38	8,35 7,08	7,25	8,35 7,08	7,88	8,35 7,08	8,50	8,35 7,08	11,00	8,35 7,08
ESCRFTC10.0X260	248	-	-	4,13	8,54 6,11	4,75	8,66 6,47	6,00	8,66 7,26	6,38	8,66 7,39	7,25	8,66 7,39	7,88	8,66 7,39	8,50	8,66 7,39	11,00	8,66 7,39
ESCRFTC10.0X280	268	-	-	4,13	8,85 6,11	4,75	8,98 6,47	6,00	8,98 7,26	6,38	8,98 7,47	7,25	8,98 7,47	7,88	8,98 7,47	8,50	8,98 7,47	11,00	8,98 7,47
ESCRFTC10.0X300	288	-	-	4,13	9,16 6,11	4,75	9,29 6,47	6,00	9,29 7,26	6,38	9,29 7,47	7,25	9,29 7,47	7,88	9,29 7,47	8,50	9,29 7,47	11,00	9,29 7,47
ESCRFTC10.0X350	338	-	-	4,13	9,77 6,11	4,75	10,01 6,47	6,00	10,01 7,26	6,38	10,01 7,47	7,25	10,01 7,47	7,88	10,01 7,47	8,50	10,01 7,47	11,00	10,01 7,47
ESCRFTC10.0X400	376	-	-	2,63	9,77 6,11	3,25	10,01 6,47	4,50	10,01 7,26	4,88	10,01 7,47	5,75	10,01 7,47	6,38	10,01 7,47	7,00	10,01 7,47	9,50	10,01 7,47
ESCRFTC10.0X450	426	-	-	2,63	9,77 6,11	3,25	10,01 6,47	4,50	10,01 7,26	4,88	10,01 7,47	5,75	10,01 7,47	6,38	10,01 7,47	7,00	10,01 7,47	9,50	10,01 7,47

Table continues on next page.

### 3.1 Solid Timber Fastening

#### ESCRFTC – Characteristic Tension and Shear Capacities, Perpendicular (90°) to the Grain Timber to Timber C24 (continued)

Product Reference	Thread Length $L_y$ [mm]	Tension Capacity $R_{ax,k}$ and Shear Capacity $R_{v,90°k}$ Perpendicular to the Grain Depending on $t_1$ [kN]																		
		Wood Thickness $t_1$ [mm]																		
		36	45	50	60	63	70	75	80	100	36	45	50	60	63	70	75	80	100	
ESCRFTC12.0X200	180	-	-	-	-	-	-	-	-	-	-	-	-	-	-	-	8,06	8,76	10,75	8,76
																		7,10		7,10
ESCRFTC12.0X220	200	-	-	-	-	-	-	-	-	-	-	-	-	-	-	-	8,06	9,09	10,75	9,09
																		7,43		7,43
ESCRFTC12.0X240	220	-	-	-	-	-	-	-	-	-	-	-	-	-	-	-	8,06	9,43	10,75	9,43
																		7,77		7,77
ESCRFTC12.0X260	240	-	-	-	-	-	-	-	-	-	-	-	-	-	-	-	8,06	9,76	10,75	9,76
																		8,11		8,11
ESCRFTC12.0X280	260	-	-	-	-	-	-	-	-	-	-	-	-	-	-	-	8,06	10,10	10,75	10,10
																		8,44		8,44
ESCRFTC12.0X300	280	-	-	-	-	-	-	-	-	-	-	-	-	-	-	-	8,06	10,44	10,75	10,44
																		8,78		8,78
ESCRFTC12.0X350	330	-	-	-	-	-	-	-	-	-	-	-	-	-	-	-	8,06	11,28	10,75	11,28
																		9,16		9,16
ESCRFTC12.0X400	380	-	-	-	-	-	-	-	-	-	-	-	-	-	-	-	8,06	12,12	10,75	12,12
																		9,16		9,16
ESCRFTC12.0X450	430	-	-	-	-	-	-	-	-	-	-	-	-	-	-	-	8,06	12,47	10,75	12,47
																		9,16		9,16
ESCRFTC12.0X500	480	-	-	-	-	-	-	-	-	-	-	-	-	-	-	-	8,06	12,47	10,75	12,47
																		9,16		9,16
ESCRFTC12.0X600	580	-	-	-	-	-	-	-	-	-	-	-	-	-	-	-	8,06	12,47	10,75	12,47
																		9,16		9,16

For dimensions and calculation parameters see p. 56.

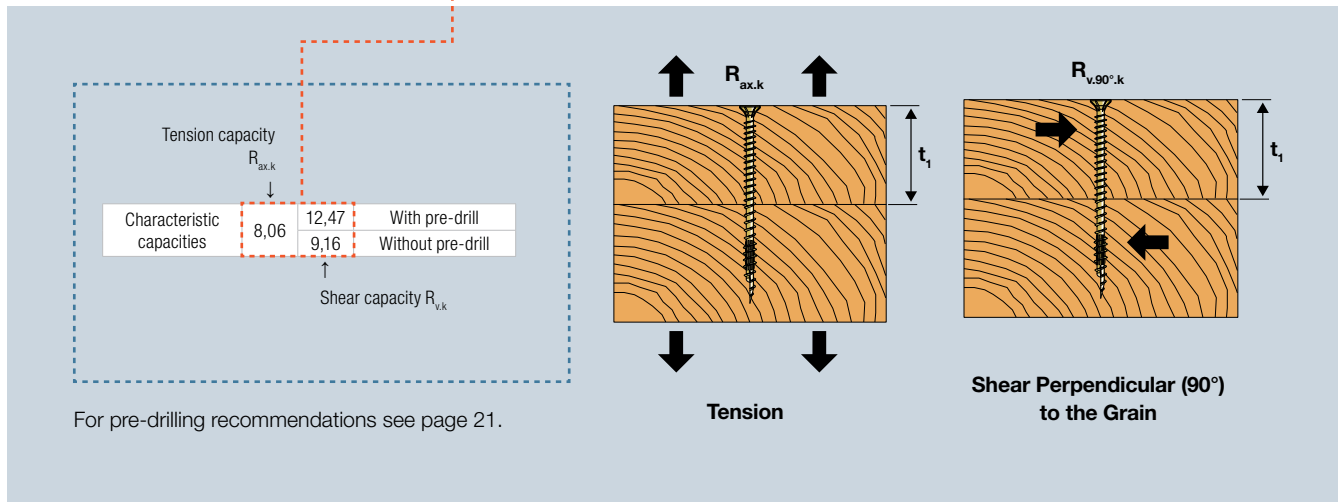

To ensure that the values in this catalog are valid, check that max. 5 mm of the thread is in the first element for partially threaded screws or that max. half the thread +/- 5 mm is in each element for the fully threaded screws.

For additional values in other configurations use Solid Wood – online dimensioning tool. Go to [solidwood.strongtie.eu](http://solidwood.strongtie.eu).

If the screw you are looking for is not shown in this table, it is because the screw cannot fulfil the requirements stated above. In this case, use Solid Wood to determine the capacity of the screw.

### 3.1 Solid Timber Fastening

#### ESCRFTC – Minimum Distances for Screws in Shear or Combined Loads<sup>1)</sup> Timber to Timber C24

Outer Thread Diameter d [mm]	Pre-drill	Angle Between Load Direction and Grain = 0°						Angle Between Load Direction and Grain = 90°					
		a <sub>1</sub>	a <sub>2</sub>	a <sub>3,c</sub>	a <sub>3,t</sub>	a <sub>4,c</sub>	a <sub>4,t</sub>	a <sub>1</sub>	a <sub>2</sub>	a <sub>3,c</sub>	a <sub>3,t</sub>	a <sub>4,c</sub>	a <sub>4,t</sub>
8.0	With pre-drill	40	24	56	96	24	24	32	32	56	40	24	56
	Without pre-drill	96	40	80	120	40	40	40	40	80	80	40	80
10.0	With pre-drill	50	30	70	120	30	30	40	40	70	50	30	70
	Without pre-drill	120	50	100	150	50	50	50	50	100	100	50	100
12.0	With pre-drill	60	36	84	144	36	36	48	48	84	60	36	84
	Without pre-drill	144	60	120	180	60	60	60	60	120	120	60	120

<sup>1)</sup> Minimum distances comply with EN 1995-1-1 (Eurocode 5) and ETA-13/0796

<sup>2)</sup> Values given in the table is based on the  $\rho_k \leq 350 \text{ kg/m}^3$

<sup>3)</sup> Minimum distances from the unloaded edge perpendicular to the grain may be reduced to  $a_{4,c} = 3 \times d$  if the spacing parallel to the grain ( $a_1$ ) and the end distance ( $a_{3,t}$ ) is at least  $25 \times d$ .

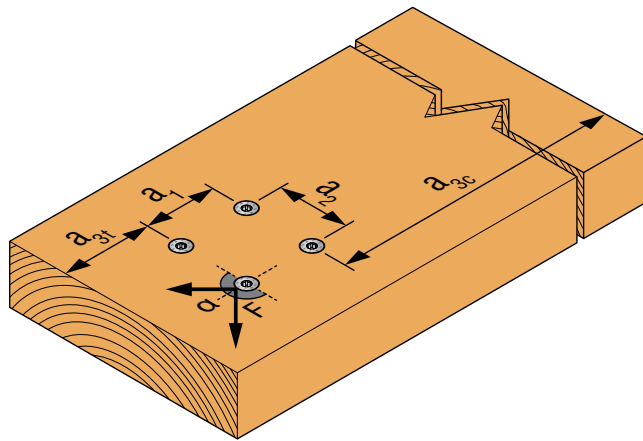

Illustration above shows angle between load direction and grain = 0°

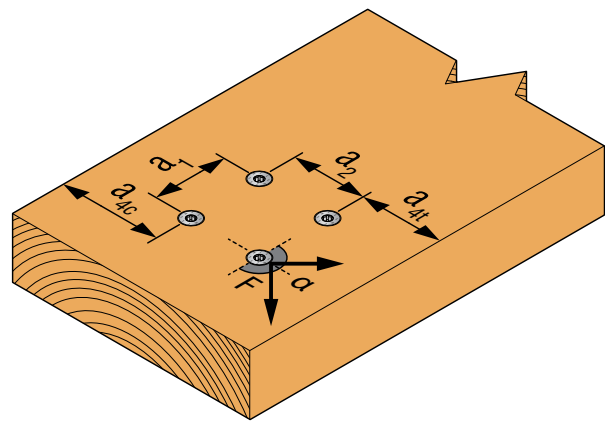

Illustration above shows angle between load direction and grain = 90°

See explanation of  $\alpha$  in General Introduction page 23.

#### ESCRFTC – Minimum Distances for Axially Loaded Screw Timber to Timber C24

Outer Thread Diameter d [mm]	a <sub>1</sub>	a <sub>2</sub>	a <sub>1,cg</sub>	a <sub>2,cg</sub>
8.0	40	20	40	32
10.0	50	25	50	40
12.0	60	30	60	48

\*Valid if the applied centre distances comply with  $a_1, a_2 \geq 25d^2$ .  
Calculation according to EN1995-1-1:2004+A2:2014.

For axially loaded screws installed perpendicular to the surface  $a_{3,t}$  and  $a_{4,t}$  are not relevant. For more info see General Introduction page 24.

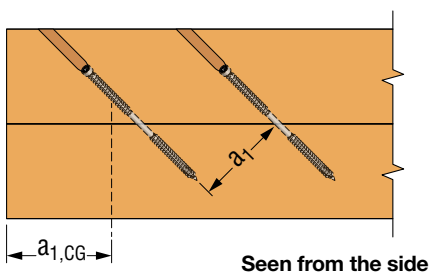

Seen from the side

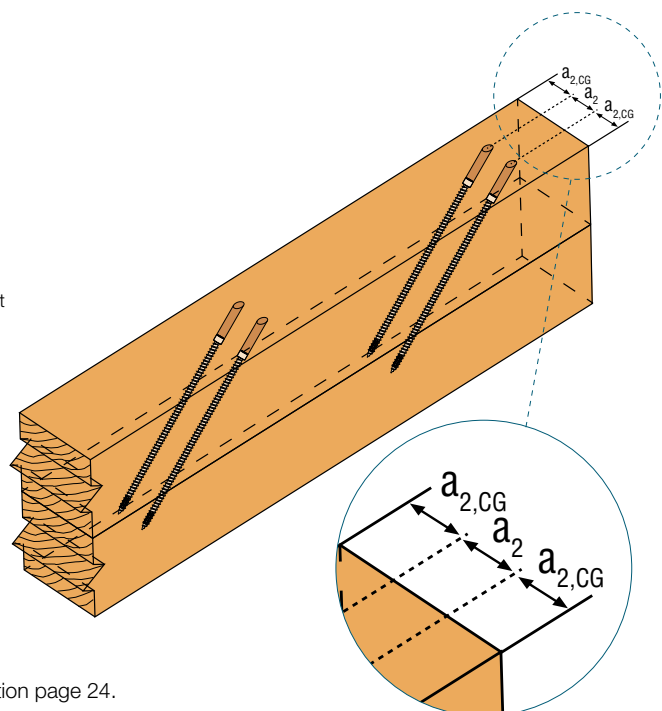

See explanation of min. space and edge distances in General Introduction page 24.

### 3.1 Solid Timber Fastening

## Solid-Drive™ ESCRFTZ Full Threaded WOOD Screw for Timber to Timber

Yellow Zinc Plated  
C2 acc. to EN ISO 12944-2  
SC2 – 50 years acc. to EC5

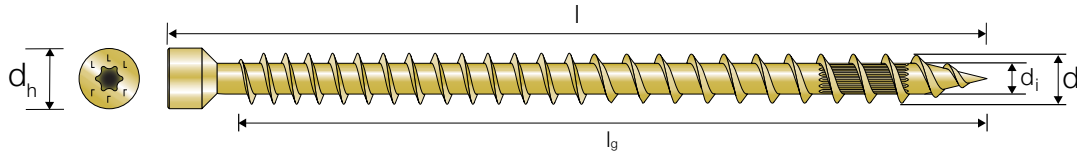

ESCRFTZ – Characteristic Tension and Shear Capacities, Parallel (0°) to the Grain  
Timber to Timber C24

Product Reference	Thread Length L <sub>g</sub> [mm]	Tension Capacity R <sub>ax,k</sub> and Shear Capacity R <sub>v,0°:k</sub> Parallel to the Grain Depending on t <sub>1</sub> [kN]																	
		Wood Thickness t <sub>1</sub> [mm]																	
		36		45		50		60		63		70		75		80		100	
ESCRFTZ8.0X120	110	2,72	4,53 3,40	3,67	4,68 3,70	4,19	4,68 3,87	5,24	4,68 3,88	5,55	4,68 3,87	5,24	4,68 3,87	4,72	4,68 3,70	4,19	4,68 3,53	-	-
ESCRFTZ8.0X140	130	2,72	4,80 3,67	3,67	4,94 3,96	4,19	4,94 4,13	5,24	4,94 4,14	5,55	4,94 4,14	6,29	4,94 4,14	6,81	4,94 4,14	6,29	4,94 4,14	4,19	4,94 3,79
ESCRFTZ8.0X160	150	2,72	5,06 3,93	3,67	5,20 4,22	4,19	5,20 4,39	5,24	5,20 4,40	5,55	5,20 4,40	6,29	5,20 4,40	6,81	5,20 4,40	7,34	5,20 4,40	6,29	5,20 4,40
ESCRFTZ8.0X180	170	2,72	5,32 4,19	3,67	5,46 4,48	4,19	5,46 4,66	5,24	5,46 4,67	5,55	5,46 4,67	6,29	5,46 4,67	6,81	5,46 4,67	7,34	5,46 4,67	8,38	5,46 4,67
ESCRFTZ8.0X200	190	2,72	5,58 4,19	3,67	5,73 4,74	4,19	5,73 4,92	5,24	5,73 4,93	5,55	5,73 4,93	6,29	5,73 4,93	6,81	5,73 4,93	7,34	5,73 4,93	9,43	5,73 4,93
ESCRFTZ8.0X220	210	2,72	5,84 4,19	3,67	5,99 4,77	4,19	5,99 5,12	5,24	5,99 5,14	5,55	5,99 5,14	6,29	5,99 5,14	6,81	5,99 5,14	7,34	5,99 5,14	9,43	5,99 5,14
ESCRFTZ8.0X240	230	2,72	6,11 4,19	3,67	6,25 4,77	4,19	6,25 5,12	5,24	6,25 5,14	5,55	6,25 5,14	6,29	6,25 5,14	6,81	6,25 5,14	7,34	6,25 5,14	9,43	6,25 5,14
ESCRFTZ8.0X260	250	2,72	6,37 4,19	3,67	6,51 4,77	4,19	6,51 5,12	5,24	6,51 5,14	5,55	6,51 5,14	6,29	6,51 5,14	6,81	6,51 5,14	7,34	6,51 5,14	9,43	6,51 5,14
ESCRFTZ8.0X280	270	2,72	6,45 4,19	3,67	6,74 4,77	4,19	6,74 5,12	5,24	6,74 5,14	5,55	6,74 5,14	6,29	6,74 5,14	6,81	6,74 5,14	7,34	6,74 5,14	9,43	6,74 5,14
ESCRFTZ8.0X300	290	2,72	6,45 4,19	3,67	6,74 4,77	4,19	6,74 5,12	5,24	6,74 5,14	5,55	6,74 5,14	6,29	6,74 5,14	6,81	6,74 5,14	7,34	6,74 5,14	9,43	6,74 5,14
ESCRFTZ8.0X350	340	2,72	6,45 4,19	3,67	6,74 4,77	4,19	6,74 5,12	5,24	6,74 5,14	5,55	6,74 5,14	6,29	6,74 5,14	6,81	6,74 5,14	7,34	6,74 5,14	9,43	6,74 5,14
ESCRFTZ8.0X400	390	2,72	6,45 4,19	3,67	6,74 4,77	4,19	6,74 5,12	5,24	6,74 5,14	5,55	6,74 5,14	6,29	6,74 5,14	6,81	6,74 5,14	7,34	6,74 5,14	9,43	6,74 5,14

For dimensions and calculation parameters see p. 58.

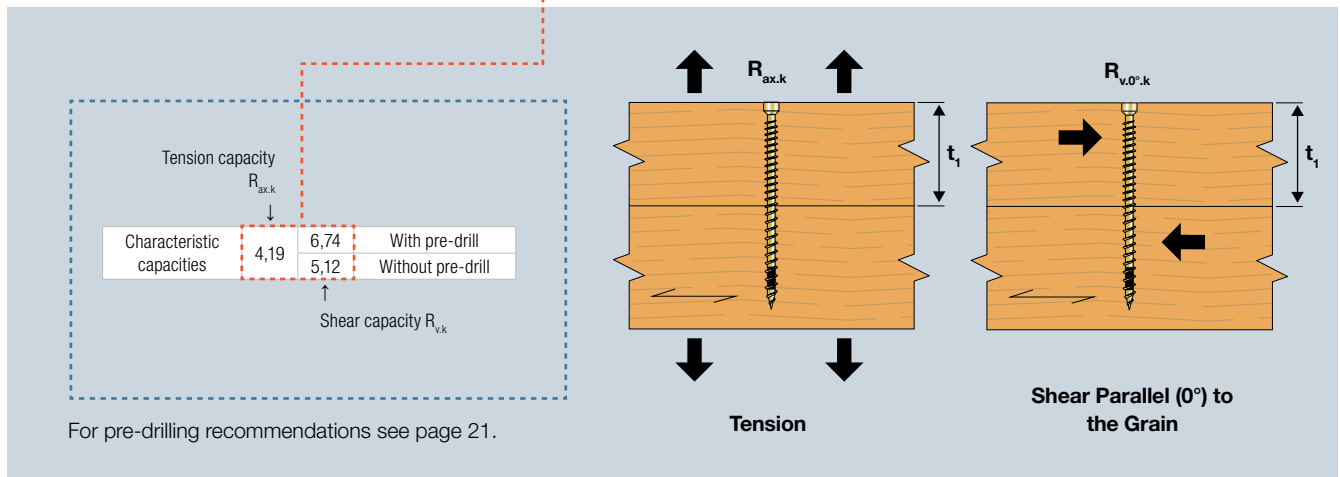

### 3.1 Solid Timber Fastening

#### ESCRFTZ – Characteristic Tension and Shear Capacities, Perpendicular (90°) to the Grain Timber to Timber C24

Product Reference	Thread Length $L_y$ [mm]	Tension Capacity $R_{ax,k}$ and Shear Capacity $R_{v,90°k}$ Perpendicular to the Grain Depending on $t_1$ [kN]																	
		Wood Thickness $t_1$ [mm]																	
		36		45		50		60		63		70		75		80		100	
ESCRFTZ8.0X120	110	2,72	4,53 3,40	3,67	4,68 3,70	4,19	4,68 3,87	5,24	4,68 3,88	5,55	4,68 3,88	5,24	4,68 3,87	4,72	4,68 3,70	4,19	4,68 3,53	-	-
ESCRFTZ8.0X140	130	2,72	4,80 3,67	3,67	4,94 3,96	4,19	4,94 4,13	5,24	4,94 4,14	5,55	4,94 4,14	6,29	4,94 4,14	6,81	4,94 4,14	6,29	4,94 4,14	4,19	4,94 3,79
ESCRFTZ8.0X160	150	2,72	5,06 3,93	3,67	5,20 4,22	4,19	5,20 4,39	5,24	5,20 4,40	5,55	5,20 4,40	6,29	5,20 4,40	6,81	5,20 4,40	7,34	5,20 4,40	6,29	5,20 4,40
ESCRFTZ8.0X180	170	2,72	5,32 4,19	3,67	5,46 4,48	4,19	5,46 4,66	5,24	5,46 4,67	5,55	5,46 4,67	6,29	5,46 4,67	6,81	5,46 4,67	7,34	5,46 4,67	8,38	5,46 4,67
ESCRFTZ8.0X200	190	2,72	5,58 4,19	3,67	5,73 4,74	4,19	5,73 4,92	5,24	5,73 4,93	5,55	5,73 4,93	6,29	5,73 4,93	6,81	5,73 4,93	7,34	5,73 4,93	9,43	5,73 4,93
ESCRFTZ8.0X220	210	2,72	5,84 4,19	3,67	5,99 4,77	4,19	5,99 5,12	5,24	5,99 5,14	5,55	5,99 5,14	6,29	5,99 5,14	6,81	5,99 5,14	7,34	5,99 5,14	9,43	5,99 5,14
ESCRFTZ8.0X240	230	2,72	6,11 4,19	3,67	6,25 4,77	4,19	6,25 5,12	5,24	6,25 5,14	5,55	6,25 5,14	6,29	6,25 5,14	6,81	6,25 5,14	7,34	6,25 5,14	9,43	6,25 5,14
ESCRFTZ8.0X260	250	2,72	6,37 4,19	3,67	6,51 4,77	4,19	6,51 5,12	5,24	6,51 5,14	5,55	6,51 5,14	6,29	6,51 5,14	6,81	6,51 5,14	7,34	6,51 5,14	9,43	6,51 5,14
ESCRFTZ8.0X280	270	2,72	6,45 4,19	3,67	6,74 4,77	4,19	6,74 5,12	5,24	6,74 5,14	5,55	6,74 5,14	6,29	6,74 5,14	6,81	6,74 5,14	7,34	6,74 5,14	9,43	6,74 5,14
ESCRFTZ8.0X300	290	2,72	6,45 4,19	3,67	6,74 4,77	4,19	6,74 5,12	5,24	6,74 5,14	5,55	6,74 5,14	6,29	6,74 5,14	6,81	6,74 5,14	7,34	6,74 5,14	9,43	6,74 5,14
ESCRFTZ8.0X350	340	2,72	6,45 4,19	3,67	6,74 4,77	4,19	6,74 5,12	5,24	6,74 5,14	5,55	6,74 5,14	6,29	6,74 5,14	6,81	6,74 5,14	7,34	6,74 5,14	9,43	6,74 5,14
ESCRFTZ8.0X400	390	2,72	6,45 4,19	3,67	6,74 4,77	4,19	6,74 5,12	5,24	6,74 5,14	5,55	6,74 5,14	6,29	6,74 5,14	6,81	6,74 5,14	7,34	6,74 5,14	9,43	6,74 5,14

For dimensions and calculation parameters see p. 58.

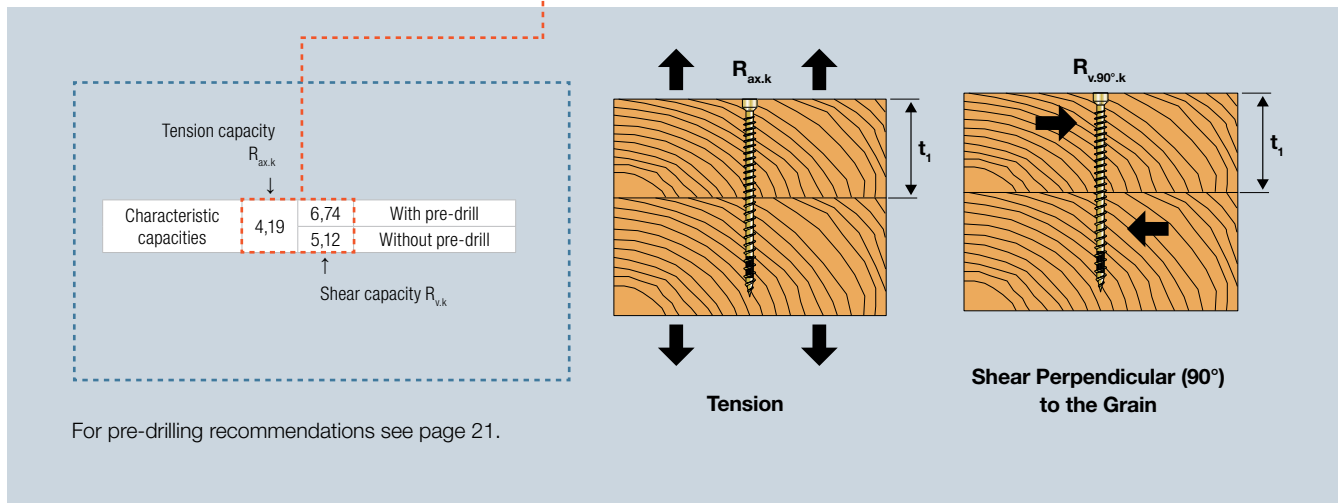

To ensure that the values in this catalog are valid, check that max. 5 mm of the thread is in the first element for partially threaded screws or that max. half the thread +/- 5 mm is in each element for the fully threaded screws.

For additional values in other configurations use Solid Wood – online dimensioning tool. Go to [solidwood.strongtie.eu](http://solidwood.strongtie.eu).

If the screw you are looking for is not shown in this table, it is because the screw cannot fulfil the requirements stated above. In this case, use Solid Wood to determine the capacity of the screw.



### 3.1 Solid Timber Fastening

## Solid-Drive™ ESCRFT Full Threaded WOOD Screw for Timber to Timber

Yellow Zinc Plated  
C2 acc. to EN ISO 12944-2  
SC2 – 50 years acc. to EC5

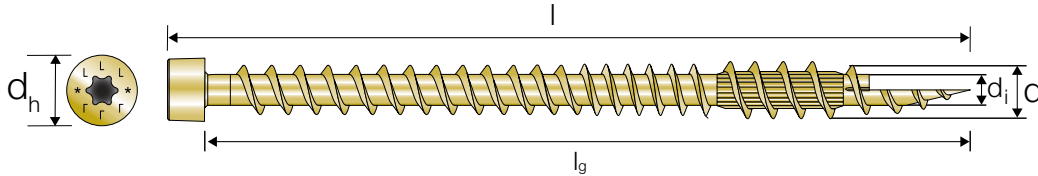

ESCRFT – Characteristic Tension and Shear Capacities, Parallel (0°) to the Grain  
Timber to Timber C24

Product Reference	Thread Length $L_g$ [mm]	Tension Capacity $R_{ax,k}$ and Shear Capacity $R_{v,0^\circ,k}$ Parallel to the Grain Depending on $t_1$ [kN]																	
		Wood Thickness $t_1$ [mm]																	
		36		45		50		60		63		70		75		80		100	
ESCRFT10.0X450	426	-	-	2,63	9,77 6,11	3,25	10,01 6,47	4,50	10,01 7,26	4,88	10,01 7,47	5,75	10,01 7,47	6,38	10,01 7,47	7,00	10,01 7,47	9,50	10,01 7,47
ESCRFT10.0X500	476	-	-	2,63	9,77 6,11	3,25	10,01 6,47	4,50	10,01 7,26	4,88	10,01 7,47	5,75	10,01 7,47	6,38	10,01 7,47	7,00	10,01 7,47	9,50	10,01 7,47
ESCRFT10.0X600	576	-	-	2,63	9,77 6,11	3,25	10,01 6,47	4,50	10,01 7,26	4,88	10,01 7,47	5,75	10,01 7,47	6,38	10,01 7,47	7,00	10,01 7,47	9,50	10,01 7,47
ESCRFT10.0X800	776	-	-	2,63	9,77 6,11	3,25	10,01 6,47	4,50	10,01 7,26	4,88	10,01 7,47	5,75	10,01 7,47	6,38	10,01 7,47	7,00	10,01 7,47	9,50	10,01 7,47
ESCRFT10.0X1000	976	-	-	2,75	9,77 6,11	3,38	10,01 6,47	4,63	10,01 7,26	5,00	10,01 7,47	5,88	10,01 7,47	6,50	10,01 7,47	7,13	10,01 7,47	9,63	10,01 7,47

For dimensions and calculation parameters see p. 60.

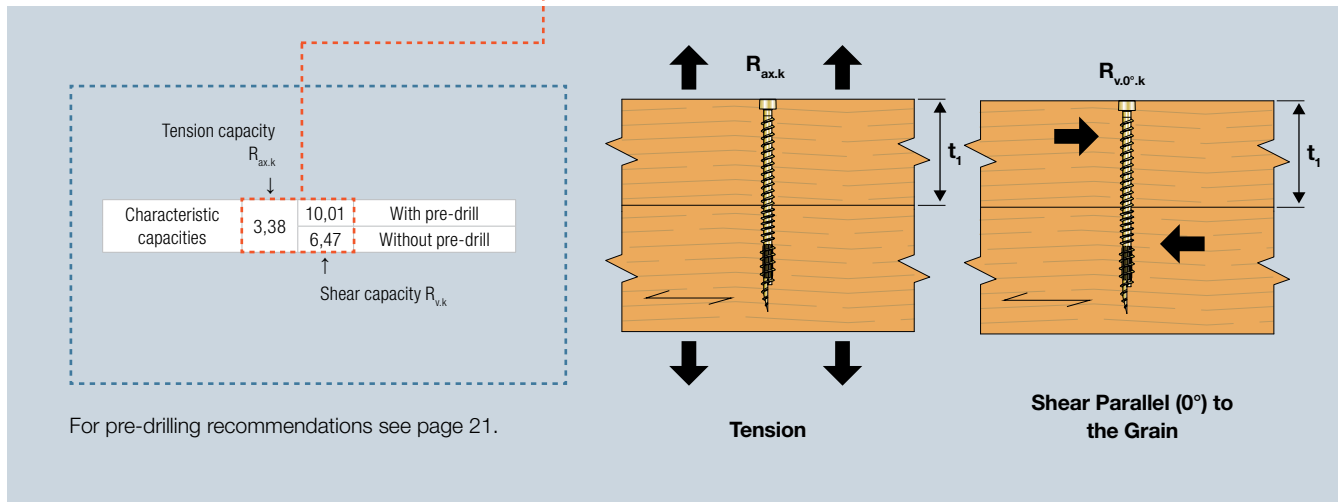

### 3.1 Solid Timber Fastening

#### ESCRFT – Characteristic Tension and Shear Capacities, Perpendicular (90°) to the Grain Timber to Timber C24

Product Reference	Thread Length $L_g$ [mm]	Tension Capacity $R_{ax,k}$ and Shear Capacity $R_{v,90^\circ,k}$ Perpendicular to the Grain Depending on $t_1$ [kN]																	
		Wood Thickness $t_1$ [mm]																	
		36		45		50		60		63		70		75		80		100	
ESCRFT10.0X450	426	-	-	2,63	9,77 6,11	3,25	10,01 6,47	4,50	10,01 7,26	4,88	10,01 7,47	5,75	10,01 7,47	6,38	10,01 7,47	7,00	10,01 7,47	9,50	10,01 7,47
ESCRFT10.0X500	476	-	-	2,63	9,77 6,11	3,25	10,01 6,47	4,50	10,01 7,26	4,88	10,01 7,47	5,75	10,01 7,47	6,38	10,01 7,47	7,00	10,01 7,47	9,50	10,01 7,47
ESCRFT10.0X600	576	-	-	2,63	9,77 6,11	3,25	10,01 6,47	4,50	10,01 7,26	4,88	10,01 7,47	5,75	10,01 7,47	6,38	10,01 7,47	7,00	10,01 7,47	9,50	10,01 7,47
ESCRFT10.0X800	776	-	-	2,63	9,77 6,11	3,25	10,01 6,47	4,50	10,01 7,26	4,88	10,01 7,47	5,75	10,01 7,47	6,38	10,01 7,47	7,00	10,01 7,47	9,50	10,01 7,47
ESCRFT10.0X1000	976	-	-	2,75	9,77 6,11	3,38	10,01 6,47	4,63	10,01 7,26	5,00	10,01 7,47	5,88	10,01 7,47	6,50	10,01 7,47	7,13	10,01 7,47	9,63	10,01 7,47

For dimensions and calculation parameters see p. 60.

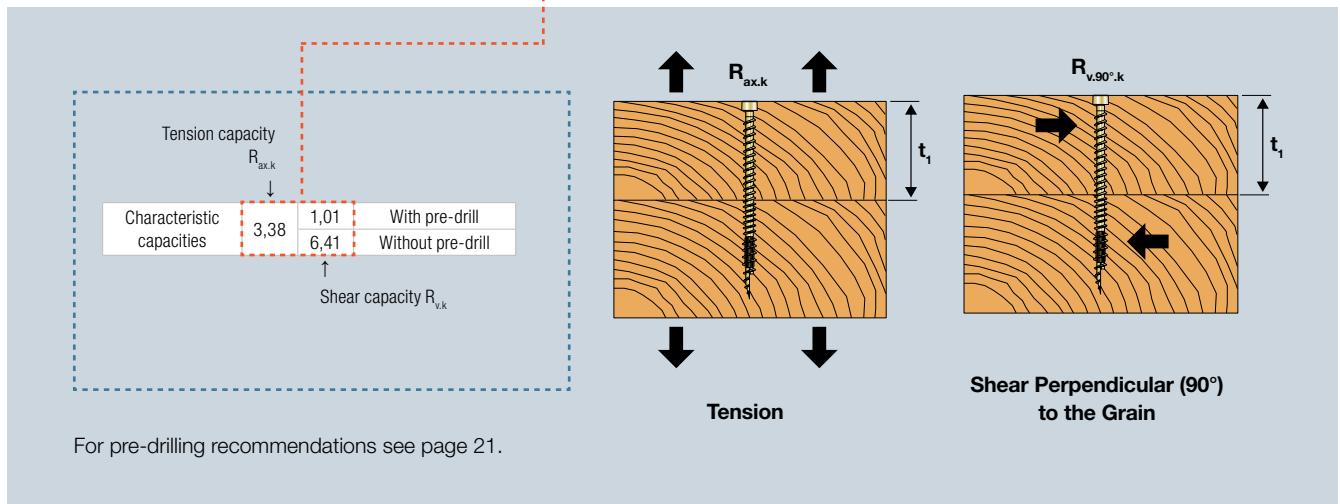

To ensure that the values in this catalog are valid, check that max. 5 mm of the thread is in the first element for partially threaded screws or that max. half the thread +/- 5 mm is in each element for the fully threaded screws.

For additional values in other configurations use Solid Wood – online dimensioning tool. Go to [solidwood.strongtie.eu](http://solidwood.strongtie.eu).

If the screw you are looking for is not shown in this table, it is because the screw cannot fulfil the requirements stated above. In this case, use Solid Wood to determine the capacity of the screw.

### 3.1 Solid Timber Fastening

#### ESCRFTZ/ESCRFT – Minimum Distances for Screws in Shear or Combined Loads<sup>1)</sup> Timber to Timber C24

Outer Thread Diameter d [mm]	Pre-drill	Angle Between Load Direction and Grain = 0°						Angle Between Load Direction and Grain = 90°					
		a <sub>1</sub>	a <sub>2</sub>	a <sub>3,c</sub>	a <sub>3,t</sub>	a <sub>4,c</sub>	a <sub>4,t</sub>	a <sub>1</sub>	a <sub>2</sub>	a <sub>3,c</sub>	a <sub>3,t</sub>	a <sub>4,c</sub>	a <sub>4,t</sub>
8.0	With pre-drill	40	24	56	96	24	24	32	32	56	40	24	56
	Without pre-drill	96	40	80	120	40	40	40	40	80	80	40	80
10.0	With pre-drill	50	30	70	120	30	30	40	40	70	50	30	70
	Without pre-drill	120	50	100	150	50	50	50	50	100	100	50	100

<sup>1)</sup> Minimum distances comply with EN 1995-1-1 (Eurocode 5) and ETA-13/0796

<sup>2)</sup> Values given in the table is based on the  $\rho_k \leq 350 \text{ kg/m}^3$

<sup>3)</sup> Minimum distances from the unloaded edge perpendicular to the grain may be reduced to  $a_{4,c} = 3 \times d$  if the spacing parallel to the grain ( $a_1$ ) and the end distance ( $a_{3,t}$ ) is at least  $25 \times d$ .

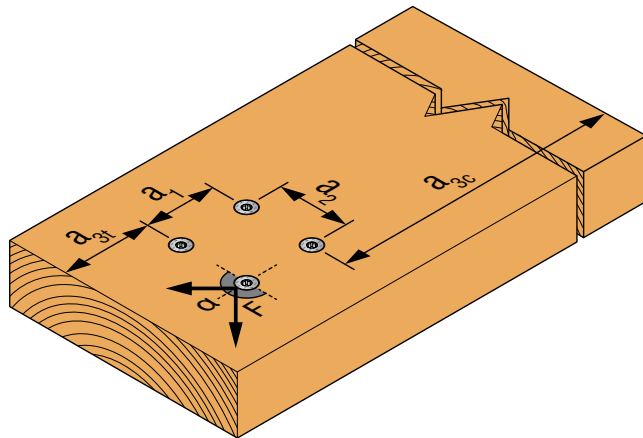

Illustration above shows angle between load direction and grain = 0°

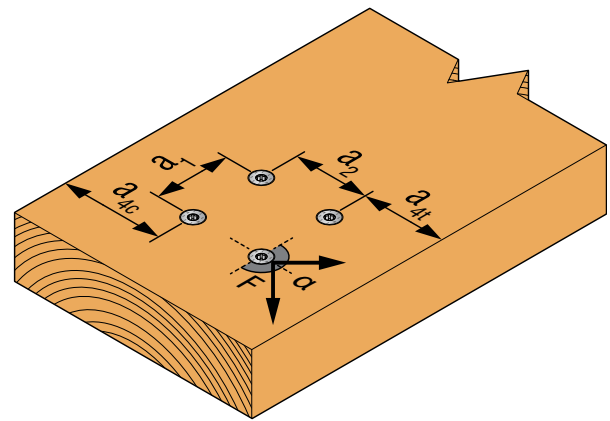

Illustration above shows angle between load direction and grain = 90°

See explanation of  $\alpha$  in General Introduction page 23.

#### ESCRFTZ/ESCRFT – Minimum Distances for Axially Loaded Screws Timber to Timber C24

Outer Thread Diameter d [mm]	a <sub>1</sub>	a <sub>2</sub>	a <sub>1,cg</sub>	a <sub>2,cg</sub>
8.0	40	20	40	32
10.0	50	25	50	40

\*Valid if the applied centre distances comply with  $a_1 \times a_2 \geq 25d^2$ .  
Calculation according to EN1995-1-1:2004+A2:2014

For axially loaded screws installed perpendicular to the surface  $a_{3,t}$  and  $a_{4,t}$  are not relevant. For more info see General Introduction page 24.

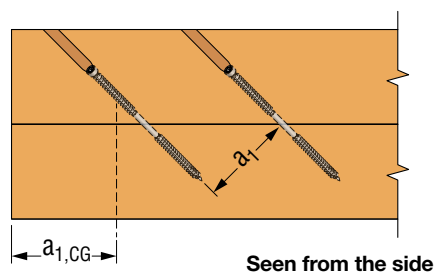

Seen from the side

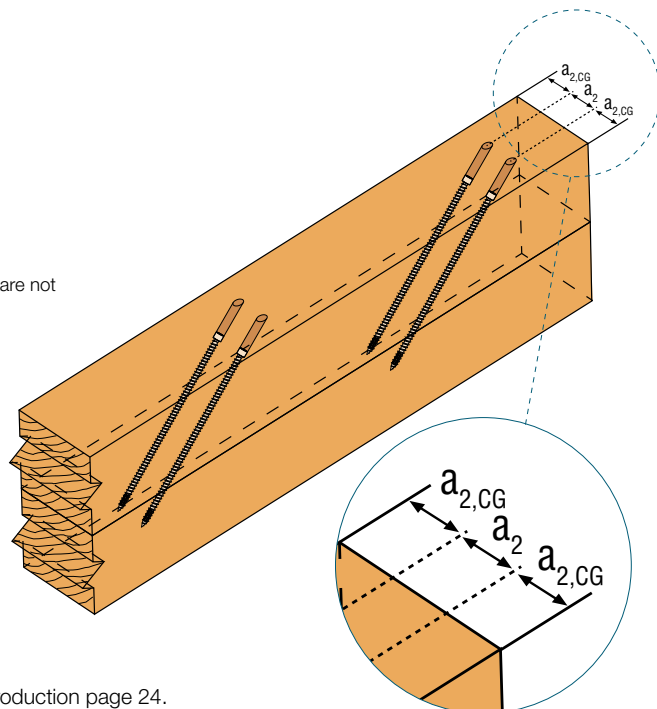

See explanation of min. space and edge distances in General Introduction page 24.

### 3.1 Solid Timber Fastening

## Solid-Drive™ SDW Structural WOOD Screw for Timber to Timber

**Electrocoat**  
C2 acc. to EN ISO 12944-2  
SC2 - 50 years acc. to EC5

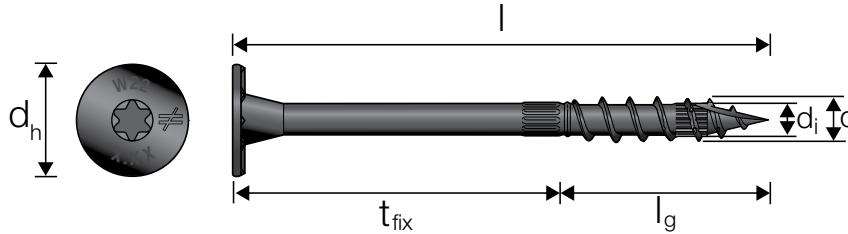

SDW – Characteristic Tension and Shear Capacities, Parallel (0°) to the Grain  
Timber to Timber C24

Product Reference	Thread Length L <sub>g</sub> [mm]	Max Advised Wood Thickness t <sub>1</sub> [mm]	Tension Capacity R <sub>ax,k</sub> and Shear Capacity R <sub>v,0°.k</sub> Parallel to the Grain Depending on t <sub>1</sub> [kN]																	
			Wood Thickness t <sub>1</sub> [mm]																	
			36	45	50	60	63	70	75	80	100	36	45	50	60	63	70	75	80	100
SDW22258(8.0x68)	33	35	3,38	3,06 2,25	-	-	-	-	-	-	-	-	-	-	-	-	-	-	-	
SDW22300(8.0x76)	36	40	3,80	3,38 2,49	3,27	3,17 2,53	-	-	-	-	-	-	-	-	-	-	-	-	-	
SDW22338(8.0x86)	40	46	4,22	3,48 2,75	4,22	3,70 2,79	3,80	3,48 2,75	-	-	-	-	-	-	-	-	-	-	-	
SDW22438(8.0x111)	37	74	3,91	3,41 2,67	3,91	3,65 2,89	3,91	3,65 3,03	3,91	3,65 3,05	3,91	3,65 2,97	3,91	3,62 2,79	3,80	3,41 2,67	-	-	-	
SDW22458(8.0x118)	36	82	3,80	3,38 2,64	3,80	3,62 2,86	3,80	3,62 3,00	3,80	3,62 3,07	3,80	3,62 3,07	3,80	3,62 2,95	3,80	3,62 2,81	3,80	3,46 2,69	-	
SDW22500(8.0x127)	40	87	4,22	3,48 2,75	4,22	3,72 2,97	4,22	3,72 3,11	4,22	3,72 3,17	4,22	3,72 3,17	4,22	3,72 3,17	4,22	3,72 3,16	4,22	3,72 3,02	-	
SDW22600(8.0x152)	37	115	3,91	3,41 2,67	3,91	3,65 2,89	3,91	3,65 3,03	3,91	3,65 3,09	3,91	3,65 3,09	3,91	3,65 3,09	3,91	3,65 3,09	3,91	3,65 3,09	3,91	3,65 3,08
SDW22638(8.0x162)	36	126	3,80	3,38 2,64	3,80	3,62 2,86	3,80	3,62 3,00	3,80	3,62 3,07	3,80	3,62 3,07	3,80	3,62 3,07	3,80	3,62 3,07	3,80	3,62 3,07	3,80	3,62 3,07
SDW22634(8.0x171)	40	131	4,22	3,48 2,75	4,22	3,72 2,97	4,22	3,72 3,11	4,22	3,72 3,17	4,22	3,72 3,17	4,22	3,72 3,17	4,22	3,72 3,17	4,22	3,72 3,17	4,22	3,72 3,17

For dimensions and calculation parameters see p. 70.

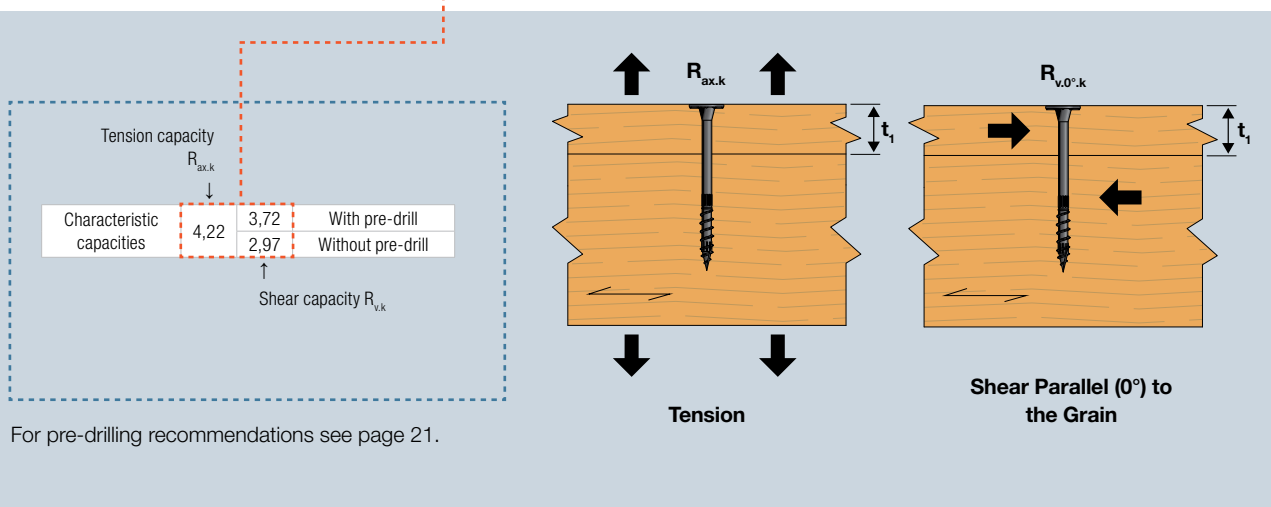

### 3.1 Solid Timber Fastening

#### SDW – Characteristic Tension and Shear Capacities, Perpendicular (90°) to the Grain Timber to Timber C24

Product Reference	Thread Length $L_g$ [mm]	Max Advised Wood Thickness $t_1$ [mm]	Tension Capacity $R_{ax,k}$ and Shear Capacity $R_{v,90^\circ,k}$ Perpendicular to the Grain Depending on $t_1$ [kN]																
			Wood Thickness $t_1$ [mm]																
			36	45	50	60	63	70	75	80	100	36	45	50	60	63	70	75	80
SDW22258(8.0x68)	33	35	3,38	3,06 2,25	-	-	-	-	-	-	-	-	-	-	-	-	-	-	-
SDW22300(8.0x76)	36	40	3,80	3,38 2,49	3,27	3,17 2,53	-	-	-	-	-	-	-	-	-	-	-	-	-
SDW22338(8.0x86)	40	46	4,22	3,48 2,75	4,22	3,70 2,79	3,80	3,48 2,75	-	-	-	-	-	-	-	-	-	-	-
SDW22438(8.0x111)	37	74	3,91	3,41 2,67	3,91	3,65 2,89	3,91	3,65 3,03	3,91	3,65 3,05	3,91	3,65 2,97	3,91	3,62 2,79	3,80	3,41 2,67	-	-	-
SDW22458(8.0x118)	36	82	3,80	3,38 2,64	3,80	3,62 2,86	3,80	3,62 3,00	3,80	3,62 3,07	3,80	3,62 3,07	3,80	3,62 2,95	3,80	3,62 2,81	3,80	3,46 2,69	-
SDW22500(8.0x127)	40	87	4,22	3,48 2,75	4,22	3,72 2,97	4,22	3,72 3,11	4,22	3,72 3,17	4,22	3,72 3,17	4,22	3,72 3,17	4,22	3,72 3,16	4,22	3,72 3,02	-
SDW22600(8.0x152)	37	115	3,91	3,41 2,67	3,91	3,65 2,89	3,91	3,65 3,03	3,91	3,65 3,09	3,91	3,65 3,09	3,91	3,65 3,09	3,91	3,65 3,09	3,91	3,65 3,09	3,91
SDW22638(8.0x162)	36	126	3,80	3,38 2,64	3,80	3,62 2,86	3,80	3,62 3,00	3,80	3,62 3,07	3,80	3,62 3,07	3,80	3,62 3,07	3,80	3,62 3,07	3,80	3,62 3,07	3,80
SDW22634(8.0x171)	40	131	4,22	3,48 2,75	4,22	3,72 2,97	4,22	3,72 3,11	4,22	3,72 3,17	4,22	3,72 3,17	4,22	3,72 3,17	4,22	3,72 3,17	4,22	3,72 3,17	4,22

For dimensions and calculation parameters see p. 70.

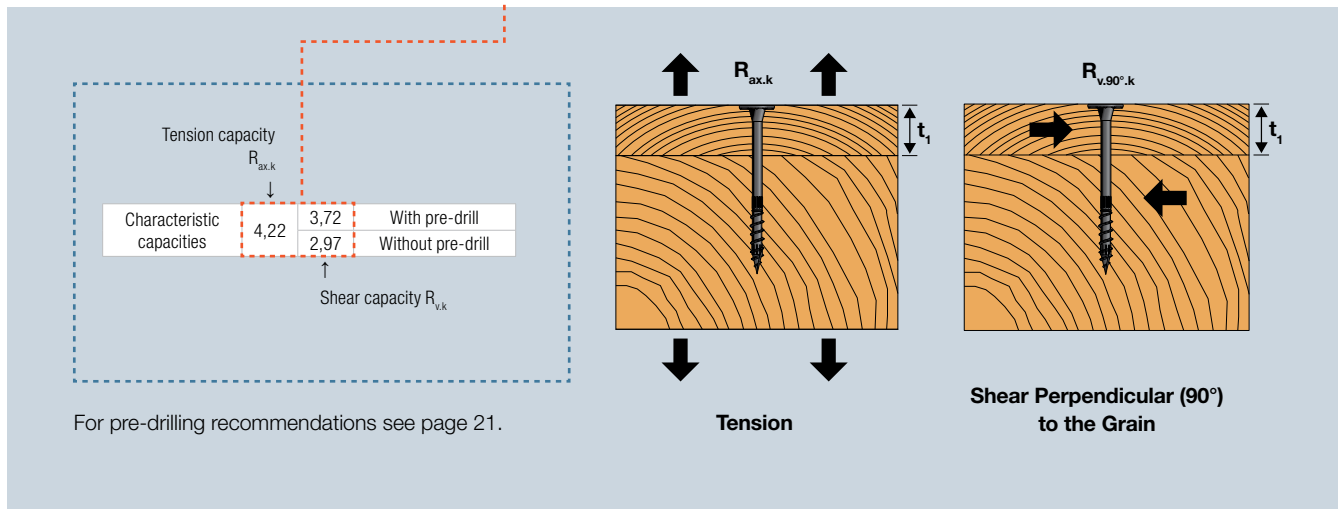

For pre-drilling recommendations see page 21.

To ensure that the values in this catalog are valid, check that max. 5 mm of the thread is in the first element for partially threaded screws or that max. half the thread +/- 5 mm is in each element for the fully threaded screws.

For additional values in other configurations use Solid Wood – online dimensioning tool. Go to [solidwood.strongtie.eu](http://solidwood.strongtie.eu).

If the screw you are looking for is not shown in this table, it is because the screw cannot fulfil the requirements stated above. In this case, use Solid Wood to determine the capacity of the screw.





### 3.1 Solid Timber Fastening

#### SDWS – Characteristic Tension and Shear Capacities, Perpendicular (90°) to the Grain Timber to Timber C24

Product Reference	Thread Length $L_g$ [mm]	Max Advised Wood Thickness $t_1$ [mm]	Tension Capacity $R_{ax,k}$ and Shear Capacity $R_{v,90^\circ,k}$ Perpendicular to the Grain Depending on $t_1$ [kN]																	
			Wood Thickness $t_1$ [mm]																	
			36	45		50	60	63	70	75	80	100								
SDWS22300(8.0x76)	36	40	3,80	3,38 2,49	3,27	3,17 2,53	-	-	-	-	-	-	-	-	-	-	-	-	-	
SDWS22400(8.0x101)	58	43	6,12	3,96 3,22	5,91	4,20 3,45	-	-	-	-	-	-	-	-	-	-	-	-	-	
SDWS22500(8.0x127)	69	57	7,29	4,25 3,38	7,29	4,49 3,74	7,29	4,49 3,87	6,97	4,49 3,94	-	-	-	-	-	-	-	-	-	
SDWS22600(8.0x152)	69	83	7,29	4,25 3,38	7,29	4,49 3,74	7,29	4,49 3,87	7,29	4,49 3,94	7,29	4,49 3,94	7,29	4,49 3,94	7,29	4,49 3,94	7,29	4,49 3,94	-	-
SDWS22800(8.0x204)	69	135	7,29	4,25 3,38	7,29	4,49 3,74	7,29	4,49 3,87	7,29	4,49 3,94	7,29	4,49 3,94	7,29	4,49 3,94	7,29	4,49 3,94	7,29	4,49 3,94	7,29	4,49 3,94
SDWS221000(8.0x253)	69	184	7,29	4,25 3,38	7,29	4,49 3,74	7,29	4,49 3,87	7,29	4,49 3,94	7,29	4,49 3,94	7,29	4,49 3,94	7,29	4,49 3,94	7,29	4,49 3,94	7,29	4,49 3,94

For dimensions and calculation parameters see p. 70.

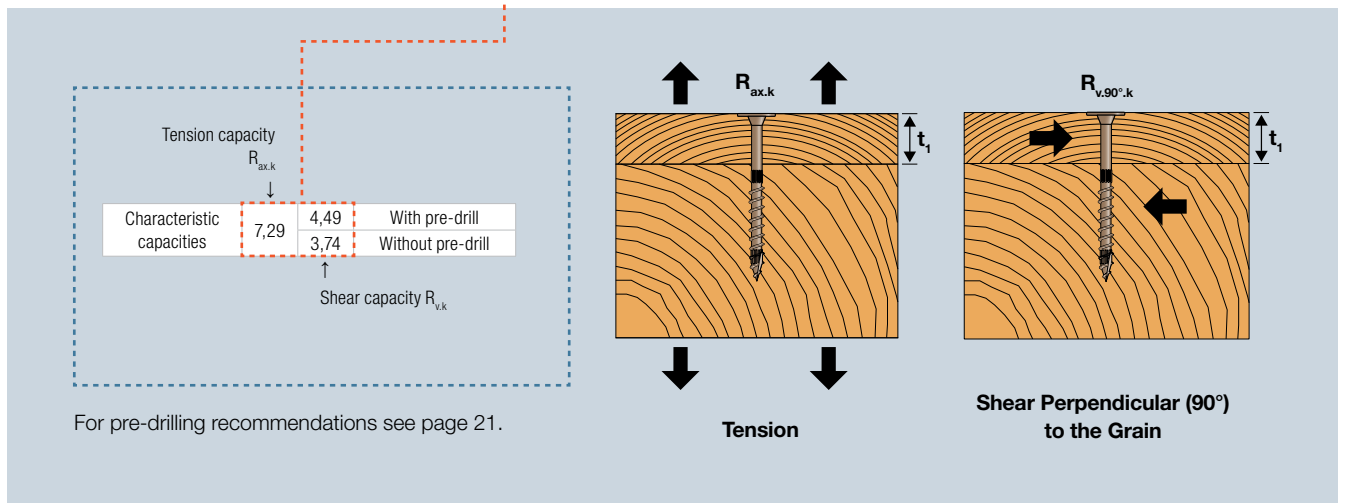

For pre-drilling recommendations see page 21.

To ensure that the values in this catalog are valid, check that max. 5 mm of the thread is in the first element for partially threaded screws or that max. half the thread +/- 5 mm is in each element for the fully threaded screws.

For additional values in other configurations use Solid Wood – online dimensioning tool. Go to [solidwood.strongtie.eu](http://solidwood.strongtie.eu).

If the screw you are looking for is not shown in this table, it is because the screw cannot fulfil the requirements stated above. In this case, use Solid Wood to determine the capacity of the screw.

### 3.1 Solid Timber Fastening

#### SDW/SDWS – Minimum Distances for Screws in Shear or Combined Loads<sup>1)</sup> Timber to Timber C24

Outer Thread Diameter d [mm]	Pre-drill	Angle Between Load Direction and Grain = 0°						Angle Between Load Direction and Grain = 90°					
		a <sub>1</sub>	a <sub>2</sub>	a <sub>3,c</sub>	a <sub>3,t</sub>	a <sub>4,c</sub>	a <sub>4,t</sub>	a <sub>1</sub>	a <sub>2</sub>	a <sub>3,c</sub>	a <sub>3,t</sub>	a <sub>4,c</sub>	a <sub>4,t</sub>
7.7	With pre-drill	39	24	54	93	24	24	31	31	54	39	24	54
	Without pre-drill	93	39	77	116	39	39	39	39	77	77	39	77

- 1) Minimum distances comply with EN 1995-1-1 (Eurocode 5)
- 2) Values given in the table is based on the  $\rho_k \leq 350 \text{ kg/m}^3$
- 3) Minimum distances from the unloaded edge perpendicular to the grain may be reduced to  $a_{4,c} = 3 \times d$  if the spacing parallel to the grain ( $a_1$ ) and the end distance ( $a_{3,t}$ ) is at least  $25 \times d$ .

#### SDW/SDWS – Minimum Distances for Axially Loaded Screws Timber to Timber C24

Outer Thread Diameter d [mm]	a <sub>1</sub>	a <sub>2</sub>	a <sub>3c</sub>	a <sub>4c</sub>
7.7	54	39	77	31

\*Valid if the applied centre distances comply with  $a_1 \times a_2 \geq 25d^2$ .  
Calculation according to EN1995-1-1:2004+A2:2014

For axially loaded screws installed perpendicular to the surface  $a_{3,t}$  and  $a_{4,t}$  are not relevant. For more info see General Introduction page 24.

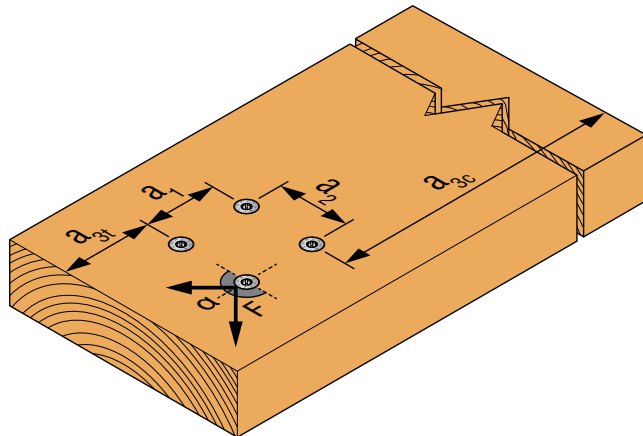

Illustration above shows angle between load direction and grain = 0°

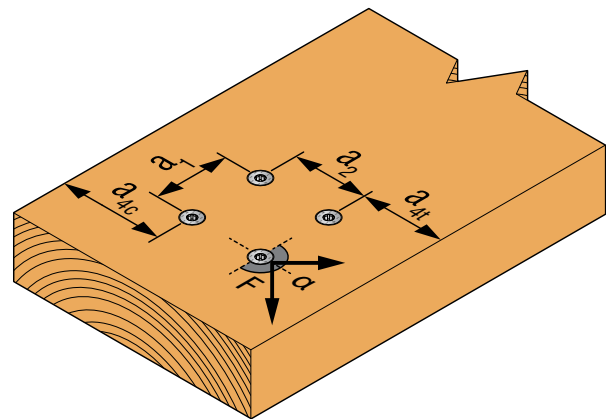

Illustration above shows angle between load direction and grain = 90°

See explanation of  $\alpha$  in General Introduction page 23.



#### Solid Wood Fastener Dimensioning Software

In just four simple steps, Solid Wood guides you through the calculation and selection of fastening solutions suitable for the specific wood structure at hand, all according to Eurocode 5 and our ETA.

Try Solid Wood today. Go to [solidwood.strongtie.eu](http://solidwood.strongtie.eu)

# ***Solid-Drive***<sup>TM</sup>

## High-Performance Structural Wood Fasteners.



### **Solid Wood** Fastener Dimensioning Software

In just four simple steps, Solid Wood guides you through the calculation and selection of fastening solutions suitable for the specific wood structure at hand, all according to Eurocode 5 and our ETA.

Try Solid Wood today. Go to [solidwood.strongtie.eu](http://solidwood.strongtie.eu)

### **Fasteners engineered with engineers in mind.**

Solid-Drive fasteners make the jobs of engineers and builders easier. Their high-performance design increases your allowable loads while speeding installation — lowering labor and material costs.

Our ETA documentation gives engineers higher safety and flexibility in their specification of wood structures and includes thorough documentation of CLT, LVL and rafter insulation fastening.

Quality. Speed. Strength. Availability. Work smarter with Simpson Strong-Tie® fasteners.

To learn more, go to [strongtie.eu](http://strongtie.eu)

**SIMPSON**

**Strong-Tie**<sup>®</sup>

## 3.2 Glulam Fastening

### General Introduction - Glulam Fastening

In this chapter you will find the characteristic values for our Solid-Drive structural fasteners in a variety of glulam applications, such as general glulam fastening, inclined installations, cross pairs and seat reinforcement.

In the tables, we give you the values both with and without pre-drilling. This is to ensure that you are always aware of the difference in capacity, and to avoid any misunderstandings.

The Minimum space and edge distances are also given for each of our fasteners. Again, we present you with the data both with and without pre-drilling.

All values given in this chapter are for GL24h. For other glulam classes see page 20.

If you are planning on using other wood thicknesses or a different glulam class than shown in the tables please refer to Solid Wood [solidwood.strongtie.eu](http://solidwood.strongtie.eu), or contact our technical support functions via email or telephone.

### Inclined Screws

Simpson Strong-Tie double- and full threaded screws are suitable for inclined screw beam to beam installations.

By installing the screws with a 30°, 45° or 60° angle inclined upwards through the secondary beam into the primary beam, you create a strong connection, taking advantage of the high load-bearing capacity of the long screws.

One of the benefits of using the inclined screws installation of glulam is that installation when standing below the beams.

Read more about inclined screws on pages 160-163 in this chapter.

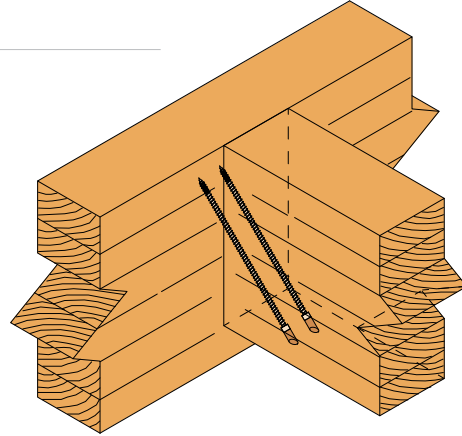

### Cross Pairs

Simpson Strong-Tie double- and full threaded screws are suitable for cross pair installations. Cross pair installations can be made by creating a single or a double screws in the middle of the glulam beam to beam connection.

Cross pairs create a very strong connection and can take both the downward loads as well as uplift. The installation is made from above the beams screwing downwards into the beams at a 45° angle.

Read more about cross pairs on pages 164-167 in this chapter.

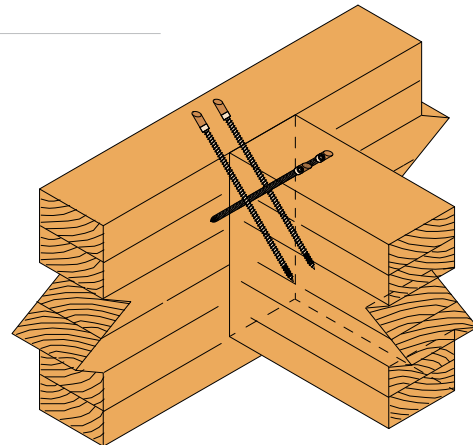

### Seat Reinforcement

Glulam elements can transfer large vertical loads on bearings. In many situations the support element might have a much higher compression resistance than the glulam element. This is the case for concrete or steel supports. This might even happen for glulam post supports as the timber compression resistance parallel to the grain is much higher than it is perpendicular to the grain.

Normally designers might increase the width of the glulam element to create a bigger area of contact. However, an efficient alternative solution to this is to reinforce the seat area with full-threaded screws, that can take over the compression forces. A steel plate is needed to distribute the forces from screws onto the bearing.

Read more about seat reinforcement on pages 168-179 in this chapter.

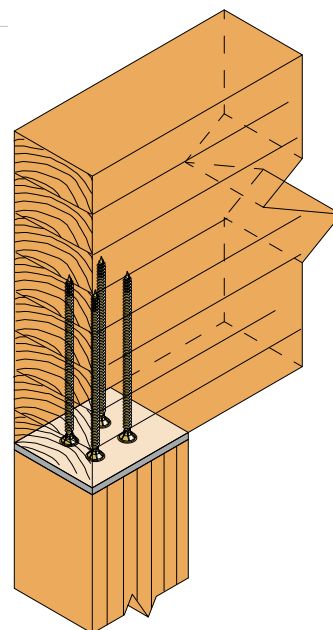

### 3.2.1 Glulam Fastening

## Solid-Drive™ TTUFS Countersunk WOOD Screw for Glulam

**Electro Galvanised**  
C1 acc. to EN ISO 12944-2  
SC2 - 50 years acc. to EC5

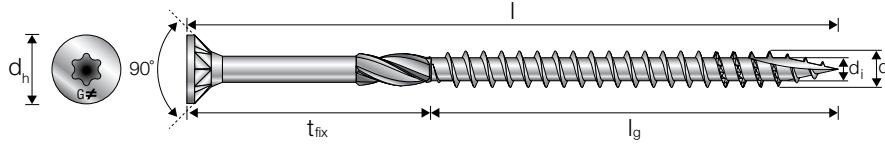

TTUFS - Characteristic Tension and Shear Capacities, Parallel (0°) to the Grain  
Glulam to Glulam GL24h

Product Reference	Thread Length L <sub>g</sub> [mm]	Max. Advised Wood Thickness t <sub>1</sub> [mm]	Tension Capacity R <sub>ax,k</sub> and Shear Capacity R <sub>v,0°k</sub> Parallel to the Grain Depending on t <sub>1</sub> [kN]															
			Wood Thickness t <sub>1</sub> [mm]															
			42		48		56		60		66		80		90		100	
TTUFS5.0X80	40	40	1,67	2,05 1,73	-	-	-	-	-	-	-	-	-	-	-	-	-	-
TTUFS5.0X90	45	45	1,67	2,05 1,73	1,67	2,05 1,73	-	-	-	-	-	-	-	-	-	-	-	-
TTUFS5.0X100	60	40	1,67	2,05 1,73	-	-	-	-	-	-	-	-	-	-	-	-	-	-
TTUFS5.0X120	60	60	1,67	2,05 1,73	1,67	2,05 1,73	1,67	2,05 1,73	1,67	2,05 1,73	-	-	-	-	-	-	-	-
TTUFS6.0X80	40	40	2,41	2,72 2,27	-	-	-	-	-	-	-	-	-	-	-	-	-	-
TTUFS6.0X90	45	45	2,41	2,72 2,27	2,41	2,72 2,27	-	-	-	-	-	-	-	-	-	-	-	-
TTUFS6.0X100	60	40	2,41	2,72 2,27	-	-	-	-	-	-	-	-	-	-	-	-	-	-
TTUFS6.0X120	70	50	2,41	2,72 2,27	2,41	2,72 2,27	-	-	-	-	-	-	-	-	-	-	-	-
TTUFS6.0X140	70	70	2,41	2,72 2,27	2,41	2,72 2,27	2,41	2,72 2,27	2,41	2,72 2,27	2,41	2,72 2,27	-	-	-	-	-	-
TTUFS6.0X160	70	90	2,41	2,72 2,27	2,41	2,72 2,27	2,41	2,72 2,27	2,41	2,72 2,27	2,41	2,72 2,27	2,41	2,72 2,27	2,41	2,72 2,27	-	-
TTUFS6.0X180	70	110	2,41	2,72 2,27	2,41	2,72 2,27	2,41	2,72 2,27	2,41	2,72 2,27	2,41	2,72 2,27	2,41	2,72 2,27	2,41	2,72 2,27	2,41	2,72 2,27

For dimensions and calculation parameters see p. 40.

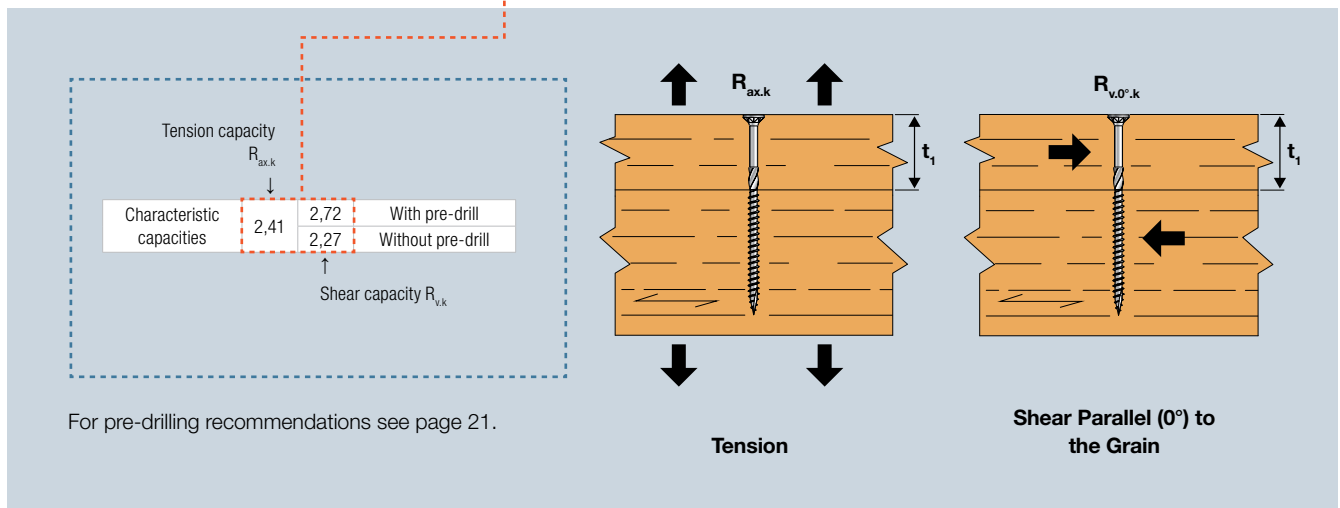

### 3.2.1 Glulam Fastening

#### TTUFS - Characteristic Tension and Shear Capacities, Perpendicular (90°) to the Grain Glulam to Glulam GL24h

Product Reference	Thread Length $L_g$ [mm]	Max. Advised Wood Thickness $t_1$ [mm]	Tension Capacity $R_{ax,k}$ and Shear Capacity $R_{v,90°k}$ Perpendicular to the Grain Depending on $t_1$ [kN]																	
			Wood Thickness $t_1$ [mm]																	
			42	48	56	60	66	80	90	100	115	42	48	56	60	66	80	90	100	115
TTUFS5.0X80	40	40	1,67	2,05 1,73	-	-	-	-	-	-	-	-	-	-	-	-	-	-	-	
TTUFS5.0X90	45	45	1,67	2,05 1,73	1,67	2,05 1,73	-	-	-	-	-	-	-	-	-	-	-	-	-	
TTUFS5.0X100	60	40	1,67	2,05 1,73	-	-	-	-	-	-	-	-	-	-	-	-	-	-	-	
TTUFS5.0X120	60	60	1,67	2,05 1,73	1,67	2,05 1,73	1,67	2,05 1,73	1,67	2,05 1,73	-	-	-	-	-	-	-	-	-	
TTUFS6.0X80	40	40	2,41	2,72 2,27	-	-	-	-	-	-	-	-	-	-	-	-	-	-	-	
TTUFS6.0X90	45	45	2,41	2,72 2,27	2,41	2,72 2,27	-	-	-	-	-	-	-	-	-	-	-	-	-	
TTUFS6.0X100	60	40	2,41	2,72 2,27	-	-	-	-	-	-	-	-	-	-	-	-	-	-	-	
TTUFS6.0X120	70	50	2,41	2,72 2,27	2,41	2,72 2,27	-	-	-	-	-	-	-	-	-	-	-	-	-	
TTUFS6.0X140	70	70	2,41	2,72 2,27	2,41	2,72 2,27	2,41	2,72 2,27	2,41	2,72 2,27	2,41	2,72 2,27	-	-	-	-	-	-	-	
TTUFS6.0X160	70	90	2,41	2,72 2,27	2,41	2,72 2,27	2,41	2,72 2,27	2,41	2,72 2,27	2,41	2,72 2,27	2,41	2,72 2,27	2,41	2,72 2,27	-	-	-	
TTUFS6.0X180	70	110	2,41	2,72 2,27	2,41	2,72 2,27	2,41	2,72 2,27	2,41	2,72 2,27	2,41	2,72 2,27	2,41	2,72 2,27	2,41	2,72 2,27	2,41	2,72 2,27	2,41	2,72 2,27

For dimensions and calculation parameters see p. 40.

Glulam

Tension capacity  $R_{ax,k}$

Characteristic capacities	2,41	2,72	With pre-drill
		2,27	Without pre-drill

Shear capacity  $R_{v,k}$

**Tension**

**Shear Perpendicular (90°) to the Grain**

For pre-drilling recommendations see page 21.

To ensure that the values in this catalog are valid, check that max. 5 mm of the thread is in the first element for partially threaded screws or that Max. half the thread +/- 5 mm is in each element for the full-threaded screws.

For additional values in other configurations use Solid Wood - online dimensioning tool. Go to [solidwood.strongtie.eu](http://solidwood.strongtie.eu).

If the screw you are looking for is not shown in this table, it is because the screw cannot fulfil the requirements stated above. In this case, use Solid Wood to determine the capacity of the screw.



### 3.2.1 Glulam Fastening

## Solid-Drive™ TTZNFS Countersunk WOOD Screw for Glulam

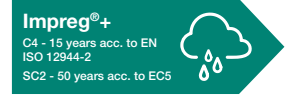

ETA-21/0670

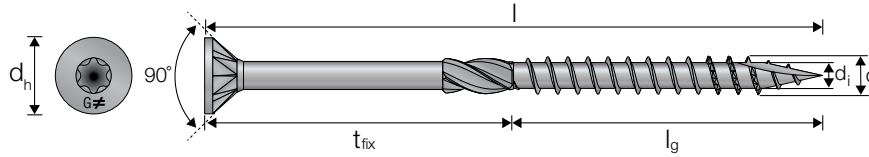

TTZNFS - Characteristic Tension and Shear Capacities, Parallel (0°) to the Grain  
Glulam to Glulam GL24h

Product Reference	Thread Length $L_g$ [mm]	Max. Advised Wood Thickness $t_1$ [mm]	Tension Capacity $R_{ax,k}$ and Shear Capacity $R_{v,0°k}$ Parallel to the Grain Depending on $t_1$ [kN]																	
			Wood Thickness $t_1$ [mm]																	
			42	48	56	60	66	80	90	100	115	42	48	56	60	66	80	90	100	115
TTZNFS5.0X80	40	40	1,67	2,05 1,73	-	-	-	-	-	-	-	-	-	-	-	-	-	-	-	
TTZNFS5.0X90	45	45	1,67	2,05 1,73	1,67	2,05 1,73	-	-	-	-	-	-	-	-	-	-	-	-	-	
TTZNFS5.0X100	60	40	1,67	2,05 1,73	-	-	-	-	-	-	-	-	-	-	-	-	-	-	-	
TTZNFS5.0X120	60	60	1,67	2,05 1,73	1,67	2,05 1,73	1,67	2,05 1,73	1,67	2,05 1,73	-	-	-	-	-	-	-	-	-	
TTZNFS6.0X80	40	40	2,41	2,72 2,27	-	-	-	-	-	-	-	-	-	-	-	-	-	-	-	
TTZNFS6.0X90	45	45	2,41	2,72 2,27	2,41	2,72 2,27	-	-	-	-	-	-	-	-	-	-	-	-	-	
TTZNFS6.0X100	60	40	2,41	2,72 2,27	-	-	-	-	-	-	-	-	-	-	-	-	-	-	-	
TTZNFS6.0X120	70	50	2,41	2,72 2,27	2,41	2,72 2,27	-	-	-	-	-	-	-	-	-	-	-	-	-	
TTZNFS6.0X140	70	70	2,41	2,72 2,27	2,41	2,72 2,27	2,41	2,72 2,27	2,41	2,72 2,27	2,41	2,72 2,27	-	-	-	-	-	-	-	
TTZNFS6.0X160	70	90	2,41	2,72 2,27	2,41	2,72 2,27	2,41	2,72 2,27	2,41	2,72 2,27	2,41	2,72 2,27	2,41	2,72 2,27	2,41	2,72 2,27	-	-	-	
TTZNFS6.0X180	70	110	2,41	2,72 2,27	2,41	2,72 2,27	2,41	2,72 2,27	2,41	2,72 2,27	2,41	2,72 2,27	2,41	2,72 2,27	2,41	2,72 2,27	2,41	2,72 2,27	2,41	2,72 2,27

For dimensions and calculation parameters see p. 40.

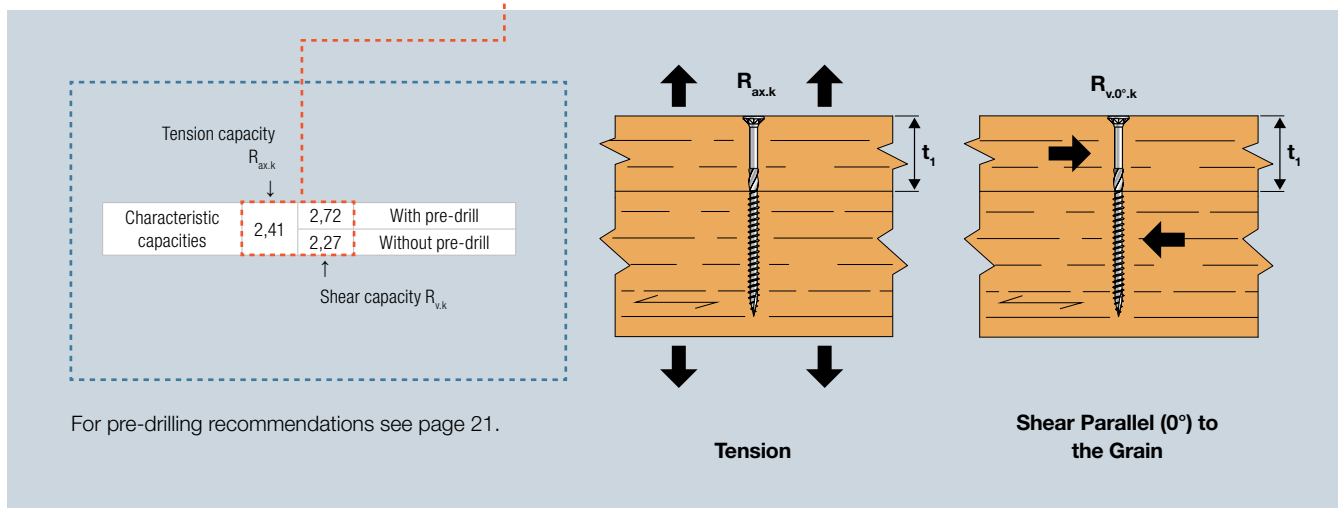

### 3.2.1 Glulam Fastening

#### TTZNFS - Characteristic Tension and Shear Capacities, Perpendicular (90°) to the Grain Glulam to Glulam GL24h

Product Reference	Thread Length $L_g$ [mm]	Max. Advised Wood Thickness $t_1$ [mm]	Tension Capacity $R_{ax,k}$ and Shear Capacity $R_{v,90^\circ,k}$ Perpendicular to the Grain Depending on $t_1$ [kN]																	
			Wood Thickness $t_1$ [mm]																	
			42	48	56	60	66	80	90	100	115	42	48	56	60	66	80	90	100	115
TTZNFS5.0X80	40	40	1,67	2,05 1,73	-	-	-	-	-	-	-	-	-	-	-	-	-	-	-	
TTZNFS5.0X90	45	45	1,67	2,05 1,73	1,67	2,05 1,73	-	-	-	-	-	-	-	-	-	-	-	-	-	
TTZNFS5.0X100	60	40	1,67	2,05 1,73	-	-	-	-	-	-	-	-	-	-	-	-	-	-	-	
TTZNFS5.0X120	60	60	1,67	2,05 1,73	1,67	2,05 1,73	1,67	2,05 1,73	1,67	2,05 1,73	-	-	-	-	-	-	-	-	-	
TTZNFS6.0X80	40	40	2,41	2,72 2,27	-	-	-	-	-	-	-	-	-	-	-	-	-	-	-	
TTZNFS6.0X90	45	45	2,41	2,72 2,27	2,41	2,72 2,27	-	-	-	-	-	-	-	-	-	-	-	-	-	
TTZNFS6.0X100	60	40	2,41	2,72 2,27	-	-	-	-	-	-	-	-	-	-	-	-	-	-	-	
TTZNFS6.0X120	70	50	2,41	2,72 2,27	2,41	2,72 2,27	-	-	-	-	-	-	-	-	-	-	-	-	-	
TTZNFS6.0X140	70	70	2,41	2,72 2,27	2,41	2,72 2,27	2,41	2,72 2,27	2,41	2,72 2,27	2,41	2,72 2,27	-	-	-	-	-	-	-	
TTZNFS6.0X160	70	90	2,41	2,72 2,27	2,41	2,72 2,27	2,41	2,72 2,27	2,41	2,72 2,27	2,41	2,72 2,27	2,41	2,72 2,27	2,41	2,72 2,27	-	-	-	
TTZNFS6.0X180	70	110	2,41	2,72 2,27	2,41	2,72 2,27	2,41	2,72 2,27	2,41	2,72 2,27	2,41	2,72 2,27	2,41	2,72 2,27	2,41	2,72 2,27	2,41	2,72 2,27	2,41	2,72 2,27

For dimensions and calculation parameters see p. 40.

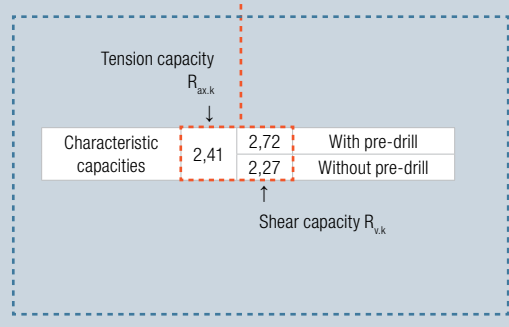

For pre-drilling recommendations see page 21.

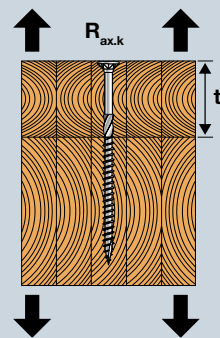

Tension

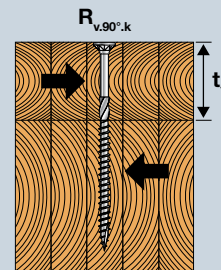

Shear Perpendicular (90°) to the Grain

To ensure that the values in this catalog are valid, check that max. 5 mm of the thread is in the first element for partially threaded screws or that max. half the thread +/- 5 mm is in each element for the full-threaded screws.

For additional values in other configurations use Solid Wood - online dimensioning tool. Go to [solidwood.strongtie.eu](http://solidwood.strongtie.eu).

If the screw you are looking for is not shown in this table, it is because the screw cannot fulfil the requirements stated above. In this case, use Solid Wood to determine the capacity of the screw.

### 3.2.1 Glulam Fastening

## Solid-Drive™ TTSFS Countersunk WOOD Screw for Glulam



ETA-21/0670

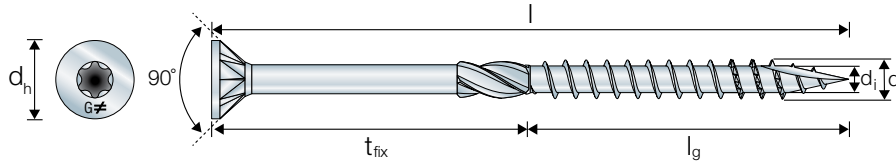

TTSFS - Characteristic Tension and Shear Capacities, Parallel (0°) to the Grain  
Glulam to Glulam GL24h

Product Reference	Thread Length $L_g$ [mm]	Max. Advised Wood Thickness $t_1$ [mm]	Tension Capacity $R_{ax,k}$ and Shear Capacity $R_{v,0°k}$ Parallel to the Grain Depending on $t_1$ [kN]															
			Wood Thickness $t_1$ [mm]															
			42	48	56	60	66	80	90	100	115							
TTSFS5.0x80	40	40	1,56	1,76 1,49	-	-	-	-	-	-	-	-	-	-	-	-	-	
TTSFS5.0x90	45	45	1,56	1,76 1,49	1,56	1,76 1,49	-	-	-	-	-	-	-	-	-	-	-	
TTSFS5.0x100	55	45	1,56	1,76 1,49	1,56	1,76 1,49	-	-	-	-	-	-	-	-	-	-	-	
TTSFS5.0x120	60	60	1,56	1,76 1,49	1,56	1,76 1,49	1,56	1,76 1,49	1,56	1,76 1,49	-	-	-	-	-	-	-	
TTSFS6.0x80	40	40	2,35	2,60 2,17	-	-	-	-	-	-	-	-	-	-	-	-	-	
TTSFS6.0x90	45	45	2,35	2,60 2,17	2,35	2,60 2,17	-	-	-	-	-	-	-	-	-	-	-	
TTSFS6.0x100	55	45	2,35	2,60 2,17	2,35	2,60 2,17	-	-	-	-	-	-	-	-	-	-	-	
TTSFS6.0x120	60	60	2,35	2,60 2,17	2,35	2,60 2,17	2,35	2,60 2,17	2,35	2,60 2,17	-	-	-	-	-	-	-	
TTSFS6.0x140	65	75	2,35	2,60 2,17	2,35	2,60 2,17	2,35	2,60 2,17	2,35	2,60 2,17	2,35	2,60 2,17	-	-	-	-	-	

For dimensions and calculation parameters see p. 40.

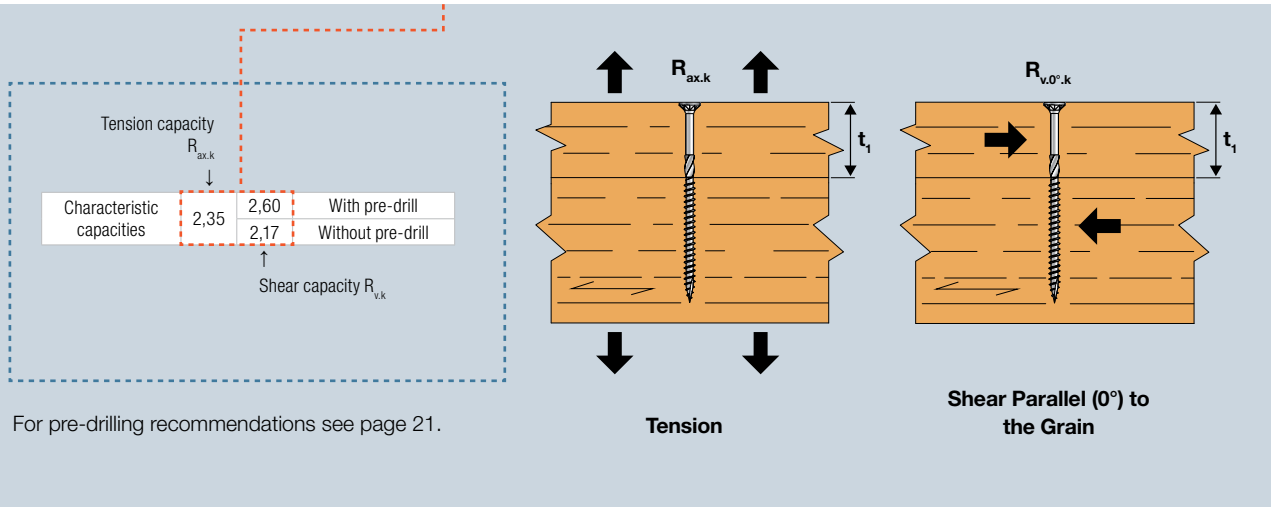

For pre-drilling recommendations see page 21.

### 3.2.1 Glulam Fastening

#### TTSFS - Characteristic Tension and Shear Capacities, Perpendicular (90°) to the Grain Glulam to Glulam GL24h

Product Reference	Thread Length $L_g$ [mm]	Max. Advised Wood Thickness $t_1$ [mm]	Tension Capacity $R_{ax,k}$ and Shear Capacity $R_{v,90^\circ,k}$ Perpendicular to the Grain Depending on $t_1$ [kN]																
			Wood Thickness $t_1$ [mm]																
			42	48	56	60	66	80	90	100	115	42	48	56	60	66	80	90	100
TTSFS5.0x80	40	40	1,56	1,76 1,49	-	-	-	-	-	-	-	-	-	-	-	-	-	-	-
TTSFS5.0x90	45	45	1,56	1,76 1,49	1,56	1,76 1,49	-	-	-	-	-	-	-	-	-	-	-	-	-
TTSFS5.0x100	55	45	1,56	1,76 1,49	1,56	1,76 1,49	-	-	-	-	-	-	-	-	-	-	-	-	-
TTSFS5.0x120	60	60	1,56	1,76 1,49	1,56	1,76 1,49	1,56	1,76 1,49	1,56	1,76 1,49	-	-	-	-	-	-	-	-	-
TTSFS6.0x80	40	40	2,35	2,60 2,17	-	-	-	-	-	-	-	-	-	-	-	-	-	-	-
TTSFS6.0x90	45	45	2,35	2,60 2,17	2,35	2,60 2,17	-	-	-	-	-	-	-	-	-	-	-	-	-
TTSFS6.0x100	55	45	2,35	2,60 2,17	2,35	2,60 2,17	-	-	-	-	-	-	-	-	-	-	-	-	-
TTSFS6.0x120	60	60	2,35	2,60 2,17	2,35	2,60 2,17	2,35	2,60 2,17	2,35	2,60 2,17	-	-	-	-	-	-	-	-	-
TTSFS6.0x140	65	75	2,35	2,60 2,17	2,35	2,60 2,17	2,35	2,60 2,17	2,35	2,60 2,17	2,35	2,60 2,17	2,35	2,60 2,17	-	-	-	-	-

For dimensions and calculation parameters see p. 40.

Tension capacity  $R_{ax,k}$

Characteristic capacities	2,35	2,60	With pre-drill
		2,17	Without pre-drill

Shear capacity  $R_{v,k}$

**Tension**

**Shear Perpendicular (90°) to the Grain**

For pre-drilling recommendations see page 21.

To ensure that the values in this catalog are valid, check that max. 5 mm of the thread is in the first element for partially threaded screws or that max. half the thread +/- 5 mm is in each element for the full-threaded screws.

For additional values in other configurations use Solid Wood - online dimensioning tool. Go to [solidwood.strongtie.eu](http://solidwood.strongtie.eu).

If the screw you are looking for is not shown in this table, it is because the screw cannot fulfil the requirements stated above. In this case, use Solid Wood to determine the capacity of the screw.

### 3.2.1 Glulam Fastening

#### TTUFS/TTZNFS/TTSFS - Minimum distances for Screws in Shear or Combined Loads<sup>1)</sup> Glulam to Glulam GL24h

Outer Thread Diameter d [mm]	Pre-drill	Angle Between Load Direction and Grain = 0°						Angle Between Load Direction and Grain = 90°					
		a <sub>1</sub>	a <sub>2</sub>	a <sub>3,c</sub>	a <sub>3,t</sub>	a <sub>4,c</sub>	a <sub>4,t</sub>	a <sub>1</sub>	a <sub>2</sub>	a <sub>3,c</sub>	a <sub>3,t</sub>	a <sub>4,c</sub>	a <sub>4,t</sub>
4.5	With pre-drill	23	14	32	54	14	14	18	18	32	23	14	32
	Without pre-drill	45	23	45	68	23	23	23	23	45	45	23	32
5.0	With pre-drill	25	15	35	60	15	15	20	20	35	25	15	35
	Without pre-drill	60	25	50	75	25	25	25	25	50	50	25	50
6.0	With pre-drill	30	18	42	72	18	18	24	24	42	30	18	42
	Without pre-drill	72	30	60	90	30	30	30	30	60	60	30	60

<sup>1)</sup> Minimum distances comply with EN 1995-1-1 (Eurocode 5) and ETA 21/0670

<sup>2)</sup> Values given in the table are based on the  $\rho_k \leq 385 \text{ kg/m}^3$

<sup>3)</sup> Minimum distances from the unloaded edge perpendicular to the grain may be reduced to  $a_{4,c} = 3 \times d$  if the spacing parallel to the grain ( $a_1$ ) and the end distance ( $a_{3,t}$ ) is at least  $25 \times d$ .

#### TTUFS/TTZNFS/TTSFS - Minimum distances for Axially Loaded Screws Glulam to Glulam GL24h

Outer Thread Diameter d [mm]	a <sub>1</sub>	a <sub>2</sub>	a <sub>3,c</sub>	a <sub>4,c</sub>
4.5	32	23	45	18
5.0	35	25	50	20
6.0	42	30	60	24

\*Valid if the applied centre distances comply with  $a_1 \times a_2 \geq 25d^2$ .  
Calculation according to EN1995-1-1:2004+A2:2014

For axially loaded screws installed perpendicular to the surface  $a_{3,t}$  and  $a_{4,t}$  are not relevant. For more info see General Introduction page 24.

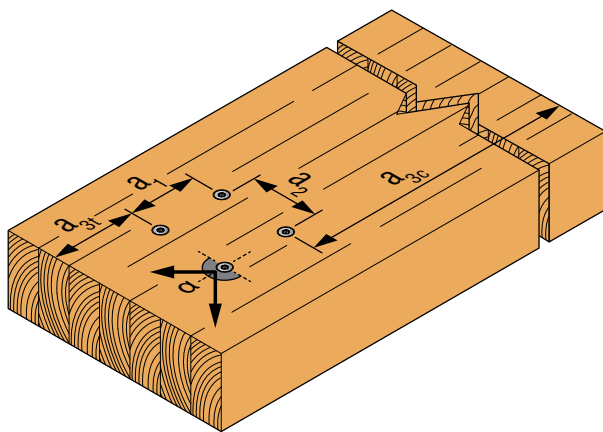

Illustration above shows angle between load direction and grain = 0°

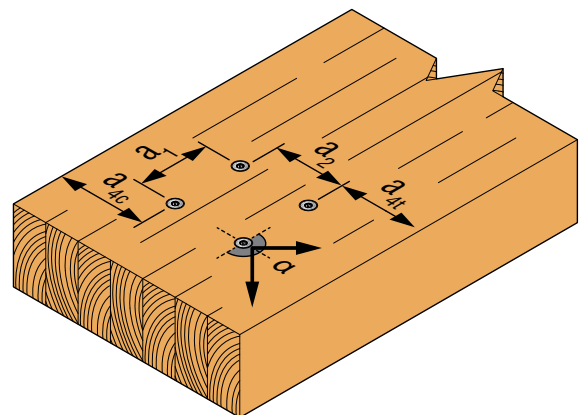

Illustration above shows angle between load direction and grain = 90°

See explanation of  $\alpha$  in General Introduction page 23.



#### Solid Wood Fastener Dimensioning Software

In just four simple steps, Solid Wood guides you through the calculation and selection of fastening solutions suitable for the specific wood structure at hand, all according to Eurocode 5 and our ETA.

Try Solid Wood today. Go to [solidwood.strongtie.eu](http://solidwood.strongtie.eu)

### 3.2.1 Glulam Fastening

## Solid-Drive™ SWW Washer-Head WOOD Screw for Glulam

Yellow Zinc Plated  
C2 acc. to EN ISO 12944-2  
SC2 - 50 years acc. to EC5

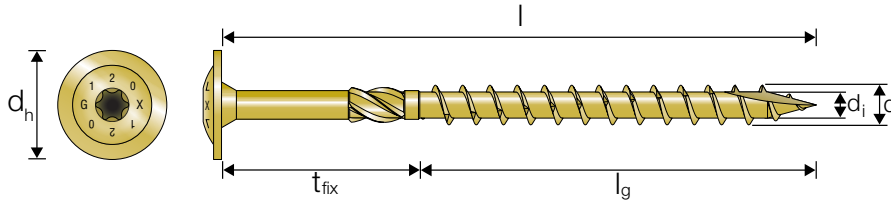

SWW - Characteristic Tension and Shear Capacities, Parallel (0°) to the Grain  
Glulam to Glulam GL24h

Product Reference	Thread Length $L_g$ [mm]	Max. Advised Wood Thickness $t_1$ [mm]	Tension Capacity $R_{ax,k}$ and Shear Capacity $R_{v,0^\circ,k}$ Parallel to the Grain Depending on $t_1$ [kN]															
			Wood Thickness $t_1$ [mm]															
			80		90		100		115		120		140		160		180	
SWW6.0X160	70	90	3,41	3,08 2,60	3,41	3,08 2,60	-	-	-	-	-	-	-	-	-	-	-	-
SWW6.0X180	70	110	3,41	3,08 2,60	3,41	3,08 2,60	3,41	3,08 2,60	3,41	3,08 2,60	-	-	-	-	-	-	-	-
SWW6.0X200	70	130	3,41	3,08 2,60	3,41	3,08 2,60	3,41	3,08 2,60	3,41	3,08 2,60	3,41	3,08 2,60	-	-	-	-	-	-
SWW6.0X220	70	150	3,41	3,08 2,60	3,41	3,08 2,60	3,41	3,08 2,60	3,41	3,08 2,60	3,41	3,08 2,60	3,41	3,08 2,60	-	-	-	-
SWW6.0X240	70	170	3,41	3,08 2,60	3,41	3,08 2,60	3,41	3,08 2,60	3,41	3,08 2,60	3,41	3,08 2,60	3,41	3,08 2,60	3,41	3,08 2,60	-	-
SWW6.0X260	70	190	3,41	3,08 2,60	3,41	3,08 2,60	3,41	3,08 2,60	3,41	3,08 2,60	3,41	3,08 2,60	3,41	3,08 2,60	3,41	3,08 2,60	3,41	3,08 2,60
SWW6.0X280	70	210	3,41	3,08 2,60	3,41	3,08 2,60	3,41	3,08 2,60	3,41	3,08 2,60	3,41	3,08 2,60	3,41	3,08 2,60	3,41	3,08 2,60	3,41	3,08 2,60
SWW6.0X300	70	230	3,41	3,08 2,60	3,41	3,08 2,60	3,41	3,08 2,60	3,41	3,08 2,60	3,41	3,08 2,60	3,41	3,08 2,60	3,41	3,08 2,60	3,41	3,08 2,60

Table continues on next page.

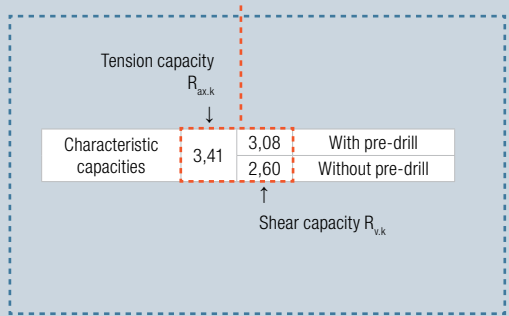

For pre-drilling recommendations see page 21.

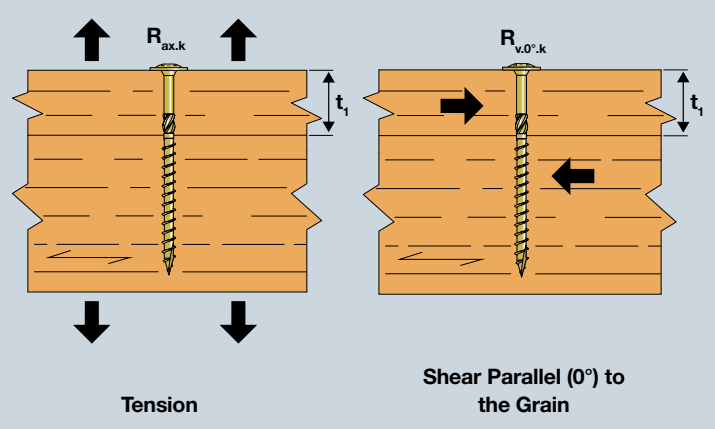

Glulam



### 3.2.1 Glulam Fastening

#### SWW - Characteristic Tension and Shear Capacities, Parallel (0°) to the Grain Glulam to Glulam GL24h (continued)

Product Reference	Thread Length $L_g$ [mm]	Max. Advised Wood Thickness $t_1$ [mm]	Tension Capacity $R_{ax,k}$ and Shear Capacity $R_{v,0°k}$ Parallel to the Grain Depending on $t_1$ [kN]																
			Wood Thickness $t_1$ [mm]																
			80	90	100	115	120	140	160	180	200	80	90	100	115	120	140	160	180
SWW8.0X160	80	80	5,48	5,36 4,42	-	-	-	-	-	-	-	-	-	-	-	-	-	-	-
SWW8.0X180	80	100	5,48	5,36 4,42	5,48	5,36 4,42	5,48	5,36 4,42	-	-	-	-	-	-	-	-	-	-	-
SWW8.0X200	80	120	5,48	5,36 4,42	5,48	5,36 4,42	5,48	5,36 4,42	5,48	5,36 4,42	5,48	5,36 4,42	-	-	-	-	-	-	-
SWW8.0X220	80	140	5,48	5,36 4,42	5,48	5,36 4,42	5,48	5,36 4,42	5,48	5,36 4,42	5,48	5,36 4,42	5,48	5,36 4,42	-	-	-	-	-
SWW8.0X240	80	160	5,48	5,36 4,42	5,48	5,36 4,42	5,48	5,36 4,42	5,48	5,36 4,42	5,48	5,36 4,42	5,48	5,36 4,42	5,48	5,36 4,42	-	-	-
SWW8.0X260	80	180	5,48	5,36 4,42	5,48	5,36 4,42	5,48	5,36 4,42	5,48	5,36 4,42	5,48	5,36 4,42	5,48	5,36 4,42	5,48	5,36 4,42	5,48	5,36 4,42	-
SWW8.0X280	80	200	5,48	5,36 4,42	5,48	5,36 4,42	5,48	5,36 4,42	5,48	5,36 4,42	5,48	5,36 4,42	5,48	5,36 4,42	5,48	5,36 4,42	5,48	5,36 4,42	5,48
SWW6.0X300	80	220	5,48	5,36 4,42	5,48	5,36 4,42	5,48	5,36 4,42	5,48	5,36 4,42	5,48	5,36 4,42	5,48	5,36 4,42	5,48	5,36 4,42	5,48	5,36 4,42	5,48
SWW8.0X320	80	240	5,48	5,36 4,42	5,48	5,36 4,42	5,48	5,36 4,42	5,48	5,36 4,42	5,48	5,36 4,42	5,48	5,36 4,42	5,48	5,36 4,42	5,48	5,36 4,42	5,48
SWW8.0X340	80	260	5,48	5,36 4,42	5,48	5,36 4,42	5,48	5,36 4,42	5,48	5,36 4,42	5,48	5,36 4,42	5,48	5,36 4,42	5,48	5,36 4,42	5,48	5,36 4,42	5,48
SWW8.0X360	80	280	5,48	5,36 4,42	5,48	5,36 4,42	5,48	5,36 4,42	5,48	5,36 4,42	5,48	5,36 4,42	5,48	5,36 4,42	5,48	5,36 4,42	5,48	5,36 4,42	5,48
SWW8.0X380	80	300	5,48	5,36 4,42	5,48	5,36 4,42	5,48	5,36 4,42	5,48	5,36 4,42	5,48	5,36 4,42	5,48	5,36 4,42	5,48	5,36 4,42	5,48	5,36 4,42	5,48
SWW8.0X400	80	320	5,48	5,36 4,42	5,48	5,36 4,42	5,48	5,36 4,42	5,48	5,36 4,42	5,48	5,36 4,42	5,48	5,36 4,42	5,48	5,36 4,42	5,48	5,36 4,42	5,48

Table continues on next page.

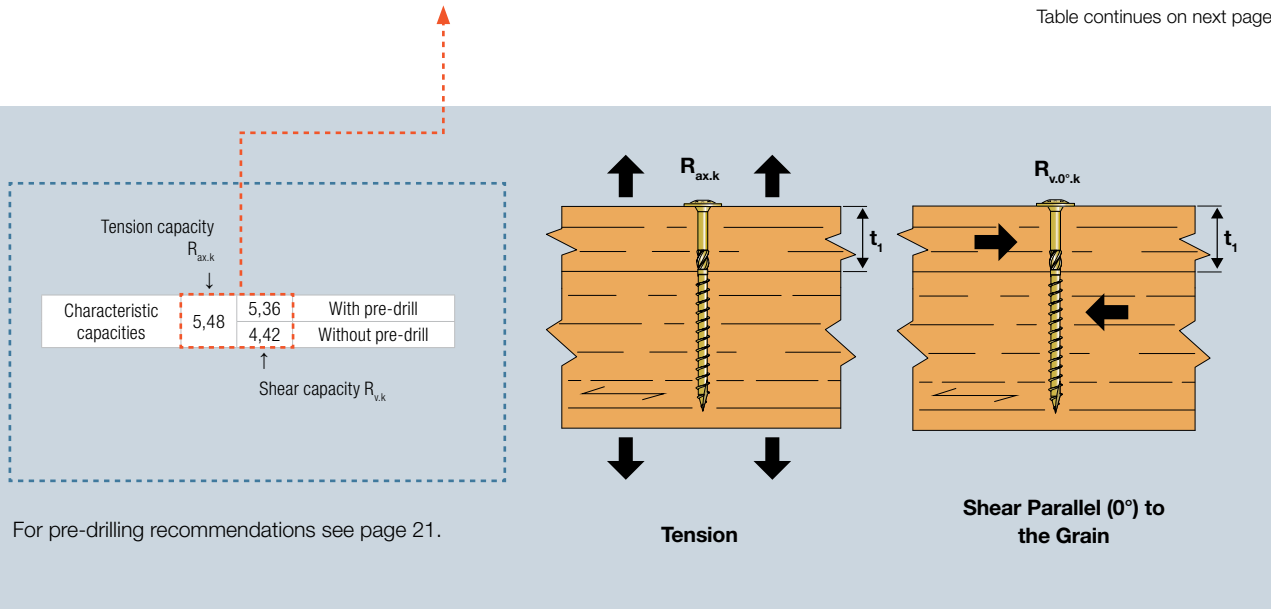

To ensure that the values in this catalog are valid, check that max. 5 mm of the thread is in the first element for partially threaded screws or that max. half the thread +/- 5 mm is in each element for the full-threaded screws.

For additional values in other configurations use Solid Wood - online dimensioning tool. Go to [solidwood.strongtie.eu](http://solidwood.strongtie.eu).

If the screw you are looking for is not shown in this table, it is because the screw cannot fulfil the requirements stated above. In this case, use Solid Wood to determine the capacity of the screw.

### 3.2.1 Glulam Fastening

SWW - Characteristic Tension and Shear Capacities, Parallel (0°) to the Grain  
 Glulam to Glulam GL24h (continued)

Product Reference	Thread Length $L_g$ [mm]	Max. Advised Wood Thickness $t_1$ [mm]	Tension Capacity $R_{ax,k}$ and Shear Capacity $R_{v,0°k}$ Parallel to the Grain Depending on $t_1$ [kN]																
			Wood Thickness $t_1$ [mm]																
			80	90	100	115	120	140	160	180	200	80	90	100	115	120	140	160	180
SWW10.0X160	80	80	6,88	7,45	-	-	-	-	-	-	-	-	-	-	-	-	-	-	-
				6,00	-	-	-	-	-	-	-	-	-	-	-	-	-	-	-
SWW10.0X180	80	100	6,88	7,45	6,88	7,45	6,88	7,45	-	-	-	-	-	-	-	-	-	-	-
				6,00		6,00		6,00											
SWW10.0X200	80	120	6,88	7,45	6,88	7,45	6,88	7,45	6,88	7,45	6,88	7,45	-	-	-	-	-	-	-
				6,00		6,00		6,00		6,00		6,00							
SWW10.0X220	80	140	6,88	7,45	6,88	7,45	6,88	7,45	6,88	7,45	6,88	7,45	6,88	7,45	-	-	-	-	-
				6,00		6,00		6,00		6,00		6,00		6,00					
SWW10.0X240	80	160	6,88	7,45	6,88	7,45	6,88	7,45	6,88	7,45	6,88	7,45	6,88	7,45	6,88	7,45	-	-	-
				6,00		6,00		6,00		6,00		6,00		6,00		6,00			
SWW10.0X260	80	180	6,88	7,45	6,88	7,45	6,88	7,45	6,88	7,45	6,88	7,45	6,88	7,45	6,88	7,45	6,88	7,45	-
				6,00		6,00		6,00		6,00		6,00		6,00		6,00		6,00	
SWW10.0X280	80	200	6,88	7,45	6,88	7,45	6,88	7,45	6,88	7,45	6,88	7,45	6,88	7,45	6,88	7,45	6,88	7,45	6,88
				6,00		6,00		6,00		6,00		6,00		6,00		6,00		6,00	
SWW10.0X300	80	220	6,88	7,45	6,88	7,45	6,88	7,45	6,88	7,45	6,88	7,45	6,88	7,45	6,88	7,45	6,88	7,45	6,88
				6,00		6,00		6,00		6,00		6,00		6,00		6,00		6,00	
SWW10.0X320	80	240	6,88	7,45	6,88	7,45	6,88	7,45	6,88	7,45	6,88	7,45	6,88	7,45	6,88	7,45	6,88	7,45	6,88
				6,00		6,00		6,00		6,00		6,00		6,00		6,00		6,00	
SWW10.0X340	80	260	6,88	7,45	6,88	7,45	6,88	7,45	6,88	7,45	6,88	7,45	6,88	7,45	6,88	7,45	6,88	7,45	6,88
				6,00		6,00		6,00		6,00		6,00		6,00		6,00		6,00	
SWW10.0X360	80	280	6,88	7,45	6,88	7,45	6,88	7,45	6,88	7,45	6,88	7,45	6,88	7,45	6,88	7,45	6,88	7,45	6,88
				6,00		6,00		6,00		6,00		6,00		6,00		6,00		6,00	
SWW10.0X380	80	300	6,88	7,45	6,88	7,45	6,88	7,45	6,88	7,45	6,88	7,45	6,88	7,45	6,88	7,45	6,88	7,45	6,88
				6,00		6,00		6,00		6,00		6,00		6,00		6,00		6,00	
SWW10.0X400	80	320	6,88	7,45	6,88	7,45	6,88	7,45	6,88	7,45	6,88	7,45	6,88	7,45	6,88	7,45	6,88	7,45	6,88
				6,00		6,00		6,00		6,00		6,00		6,00		6,00		6,00	

For dimensions and calculation parameters see p. 44.

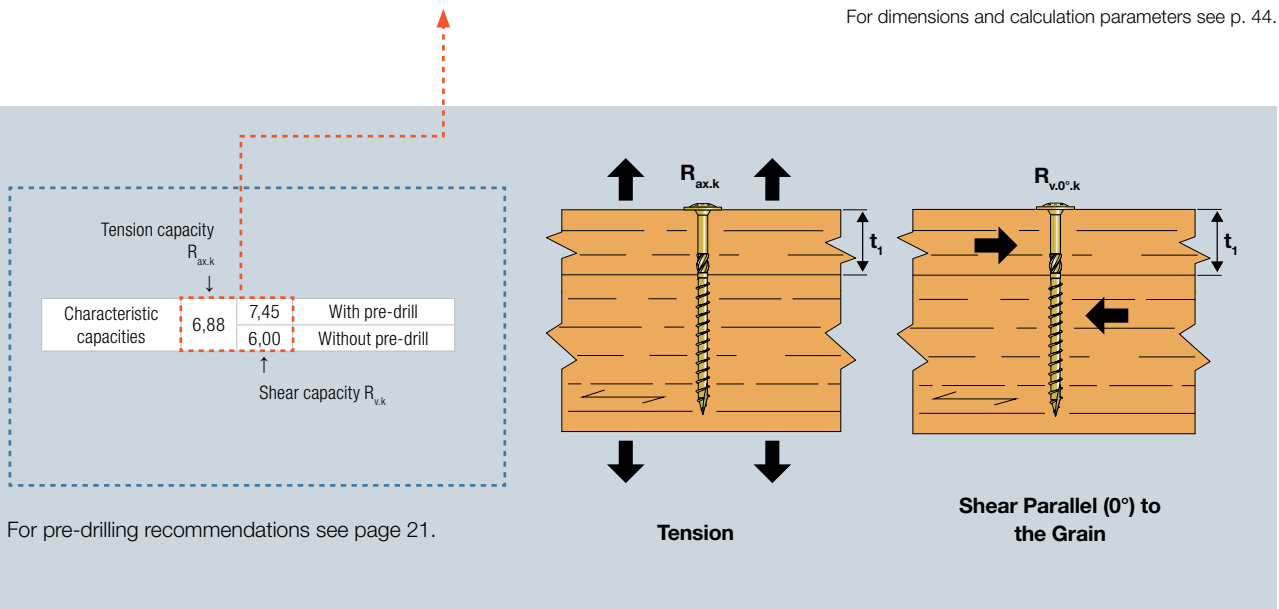

To ensure that the values in this catalog are valid, check that max. 5 mm of the thread is in the first element for partially threaded screws or that max. half the thread +/- 5 mm is in each element for the full-threaded screws.

For additional values in other configurations use Solid Wood - online dimensioning tool. Go to [solidwood.strongtie.eu](http://solidwood.strongtie.eu).

If the screw you are looking for is not shown in this table, it is because the screw cannot fulfil the requirements stated above. In this case, use Solid Wood to determine the capacity of the screw.

### 3.2.1 Glulam Fastening

#### SWW - Characteristic Tension and Shear Capacities, Perpendicular (90°) to the Grain Glulam to Glulam GL24h

Product Reference	Thread Length $L_g$ [mm]	Max. Advised Wood Thickness $t_f$ [mm]	Tension Capacity $R_{ax,k}$ and Shear Capacity $R_{v,90°k}$ Perpendicular to the Grain Depending on $t_f$ [kN]																
			Wood Thickness $t_f$ [mm]																
			80		90		100		115		120		140		160		180		200
SWW6.0X160	70	90	3,41	3,08 2,60	3,41	3,08 2,60	-	-	-	-	-	-	-	-	-	-	-	-	-
SWW6.0X180	70	110	3,41	3,08 2,60	3,41	3,08 2,60	3,41	3,08 2,60	3,41	3,08 2,60	-	-	-	-	-	-	-	-	-
SWW6.0X200	70	130	3,41	3,08 2,60	3,41	3,08 2,60	3,41	3,08 2,60	3,41	3,08 2,60	3,41	3,08 2,60	-	-	-	-	-	-	-
SWW6.0X220	70	150	3,41	3,08 2,60	3,41	3,08 2,60	3,41	3,08 2,60	3,41	3,08 2,60	3,41	3,08 2,60	3,41	3,08 2,60	-	-	-	-	-
SWW6.0X240	70	170	3,41	3,08 2,60	3,41	3,08 2,60	3,41	3,08 2,60	3,41	3,08 2,60	3,41	3,08 2,60	3,41	3,08 2,60	3,41	3,08 2,60	-	-	-
SWW6.0X260	70	190	3,41	3,08 2,60	3,41	3,08 2,60	3,41	3,08 2,60	3,41	3,08 2,60	3,41	3,08 2,60	3,41	3,08 2,60	3,41	3,08 2,60	3,41	3,08 2,60	-
SWW6.0X280	70	210	3,41	3,08 2,60	3,41	3,08 2,60	3,41	3,08 2,60	3,41	3,08 2,60	3,41	3,08 2,60	3,41	3,08 2,60	3,41	3,08 2,60	3,41	3,08 2,60	3,41
SWW6.0X300	70	230	3,41	3,08 2,60	3,41	3,08 2,60	3,41	3,08 2,60	3,41	3,08 2,60	3,41	3,08 2,60	3,41	3,08 2,60	3,41	3,08 2,60	3,41	3,08 2,60	3,41
SWW8.0X160	80	80	5,48	5,36 4,42	-	-	-	-	-	-	-	-	-	-	-	-	-	-	-
SWW8.0X180	80	100	5,48	5,36 4,42	5,48	5,36 4,42	5,48	5,36 4,42	-	-	-	-	-	-	-	-	-	-	-
SWW8.0X200	80	120	5,48	5,36 4,42	5,48	5,36 4,42	5,48	5,36 4,42	5,48	5,36 4,42	5,48	5,36 4,42	-	-	-	-	-	-	-
SWW8.0X220	80	140	5,48	5,36 4,42	5,48	5,36 4,42	5,48	5,36 4,42	5,48	5,36 4,42	5,48	5,36 4,42	5,48	5,36 4,42	-	-	-	-	-
SWW8.0X240	80	160	5,48	5,36 4,42	5,48	5,36 4,42	5,48	5,36 4,42	5,48	5,36 4,42	5,48	5,36 4,42	5,48	5,36 4,42	5,48	5,36 4,42	-	-	-
SWW8.0X260	80	180	5,48	5,36 4,42	5,48	5,36 4,42	5,48	5,36 4,42	5,48	5,36 4,42	5,48	5,36 4,42	5,48	5,36 4,42	5,48	5,36 4,42	5,48	5,36 4,42	-
SWW8.0X280	80	200	5,48	5,36 4,42	5,48	5,36 4,42	5,48	5,36 4,42	5,48	5,36 4,42	5,48	5,36 4,42	5,48	5,36 4,42	5,48	5,36 4,42	5,48	5,36 4,42	5,48
SWW6.0X300	80	220	5,48	5,36 4,42	5,48	5,36 4,42	5,48	5,36 4,42	5,48	5,36 4,42	5,48	5,36 4,42	5,48	5,36 4,42	5,48	5,36 4,42	5,48	5,36 4,42	5,48
SWW8.0X320	80	240	5,48	5,36 4,42	5,48	5,36 4,42	5,48	5,36 4,42	5,48	5,36 4,42	5,48	5,36 4,42	5,48	5,36 4,42	5,48	5,36 4,42	5,48	5,36 4,42	5,48
SWW8.0X340	80	260	5,48	5,36 4,42	5,48	5,36 4,42	5,48	5,36 4,42	5,48	5,36 4,42	5,48	5,36 4,42	5,48	5,36 4,42	5,48	5,36 4,42	5,48	5,36 4,42	5,48
SWW8.0X360	80	280	5,48	5,36 4,42	5,48	5,36 4,42	5,48	5,36 4,42	5,48	5,36 4,42	5,48	5,36 4,42	5,48	5,36 4,42	5,48	5,36 4,42	5,48	5,36 4,42	5,48
SWW8.0X380	80	300	5,48	5,36 4,42	5,48	5,36 4,42	5,48	5,36 4,42	5,48	5,36 4,42	5,48	5,36 4,42	5,48	5,36 4,42	5,48	5,36 4,42	5,48	5,36 4,42	5,48
SWW8.0X400	80	320	5,48	5,36 4,42	5,48	5,36 4,42	5,48	5,36 4,42	5,48	5,36 4,42	5,48	5,36 4,42	5,48	5,36 4,42	5,48	5,36 4,42	5,48	5,36 4,42	5,48

Table continues on next page.

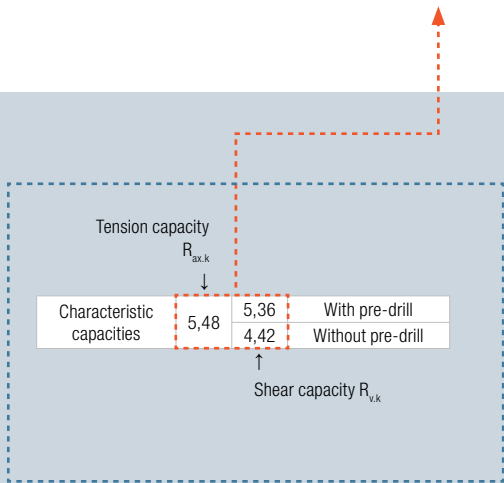

For pre-drilling recommendations see page 21.

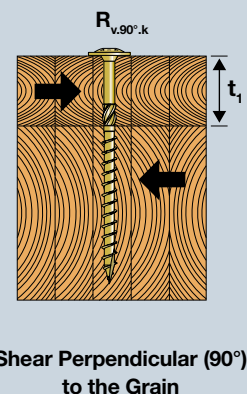
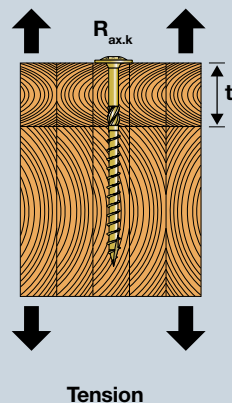

### 3.2.1 Glulam Fastening

#### SWW - Characteristic Tension and Shear Capacities, Perpendicular (90°) to the Grain Glulam to Glulam GL24h (continued)

Product Reference	Thread Length $L_g$ [mm]	Max. Advised Wood Thickness $t_1$ [mm]	Tension Capacity $R_{ax,k}$ and Shear Capacity $R_{v,90^\circ,k}$ Perpendicular to the Grain Depending on $t_1$ [kN]																	
			Wood Thickness $t_1$ [mm]																	
			80	90	100	115	120	140	160	180	200	80	90	100	115	120	140	160	180	200
SWW10.0X160	80	80	6,88	7,45 6,00	-	-	-	-	-	-	-	-	-	-	-	-	-	-	-	-
SWW10.0X180	80	100	6,88	7,45 6,00	6,88	7,45 6,00	6,88	7,45 6,00	-	-	-	-	-	-	-	-	-	-	-	-
SWW10.0X200	80	120	6,88	7,45 6,00	6,88	7,45 6,00	6,88	7,45 6,00	6,88	7,45 6,00	6,88	7,45 6,00	-	-	-	-	-	-	-	-
SWW10.0X220	80	140	6,88	7,45 6,00	6,88	7,45 6,00	6,88	7,45 6,00	6,88	7,45 6,00	6,88	7,45 6,00	6,88	7,45 6,00	-	-	-	-	-	-
SWW10.0X240	80	160	6,88	7,45 6,00	6,88	7,45 6,00	6,88	7,45 6,00	6,88	7,45 6,00	6,88	7,45 6,00	6,88	7,45 6,00	6,88	7,45 6,00	-	-	-	-
SWW10.0X260	80	180	6,88	7,45 6,00	6,88	7,45 6,00	6,88	7,45 6,00	6,88	7,45 6,00	6,88	7,45 6,00	6,88	7,45 6,00	6,88	7,45 6,00	6,88	7,45 6,00	-	-
SWW10.0X280	80	200	6,88	7,45 6,00	6,88	7,45 6,00	6,88	7,45 6,00	6,88	7,45 6,00	6,88	7,45 6,00	6,88	7,45 6,00	6,88	7,45 6,00	6,88	7,45 6,00	6,88	7,45 6,00
SWW10.0X300	80	220	6,88	7,45 6,00	6,88	7,45 6,00	6,88	7,45 6,00	6,88	7,45 6,00	6,88	7,45 6,00	6,88	7,45 6,00	6,88	7,45 6,00	6,88	7,45 6,00	6,88	7,45 6,00
SWW10.0X320	80	240	6,88	7,45 6,00	6,88	7,45 6,00	6,88	7,45 6,00	6,88	7,45 6,00	6,88	7,45 6,00	6,88	7,45 6,00	6,88	7,45 6,00	6,88	7,45 6,00	6,88	7,45 6,00
SWW10.0X340	80	260	6,88	7,45 6,00	6,88	7,45 6,00	6,88	7,45 6,00	6,88	7,45 6,00	6,88	7,45 6,00	6,88	7,45 6,00	6,88	7,45 6,00	6,88	7,45 6,00	6,88	7,45 6,00
SWW10.0X360	80	280	6,88	7,45 6,00	6,88	7,45 6,00	6,88	7,45 6,00	6,88	7,45 6,00	6,88	7,45 6,00	6,88	7,45 6,00	6,88	7,45 6,00	6,88	7,45 6,00	6,88	7,45 6,00
SWW10.0X380	80	300	6,88	7,45 6,00	6,88	7,45 6,00	6,88	7,45 6,00	6,88	7,45 6,00	6,88	7,45 6,00	6,88	7,45 6,00	6,88	7,45 6,00	6,88	7,45 6,00	6,88	7,45 6,00
SWW10.0X400	80	320	6,88	7,45 6,00	6,88	7,45 6,00	6,88	7,45 6,00	6,88	7,45 6,00	6,88	7,45 6,00	6,88	7,45 6,00	6,88	7,45 6,00	6,88	7,45 6,00	6,88	7,45 6,00

For dimensions and calculation parameters see p. 44.

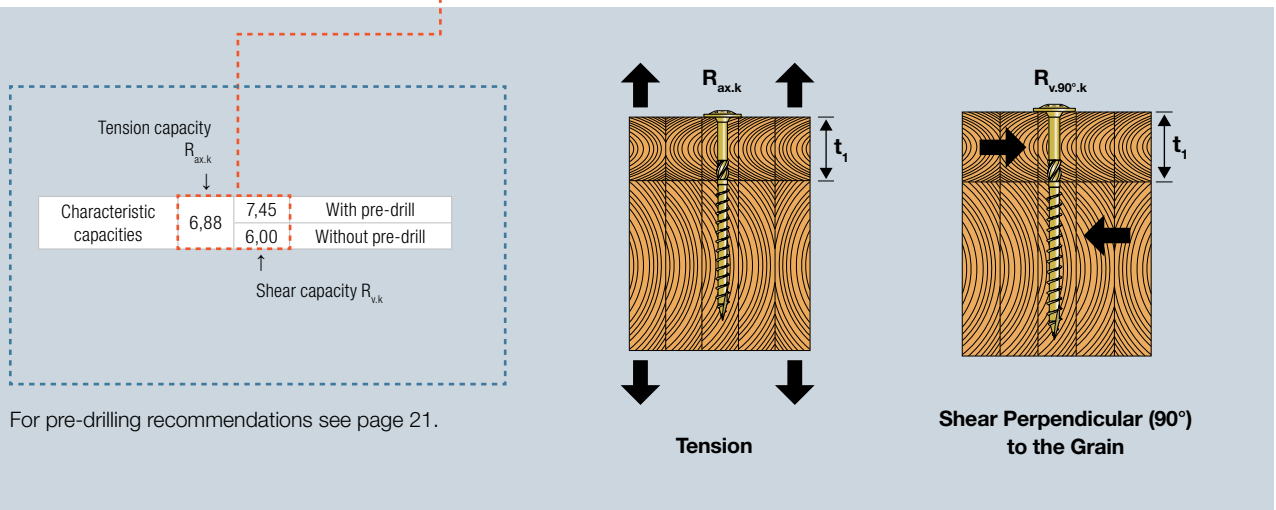

To ensure that the values in this catalog are valid, check that max. 5 mm of the thread is in the first element for partially threaded screws or that max. half the thread +/- 5 mm is in each element for the full-threaded screws.

For additional values in other configurations use Solid Wood - online dimensioning tool. Go to [solidwood.strongtie.eu](http://solidwood.strongtie.eu).

If the screw you are looking for is not shown in this table, it is because the screw cannot fulfil the requirements stated above. In this case, use Solid Wood to determine the capacity of the screw.

### 3.2.1 Glulam Fastening

## Solid-Drive™ SWWZ Washer-Head WOOD Screw for Glulam

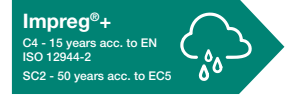

ETA-21/0670

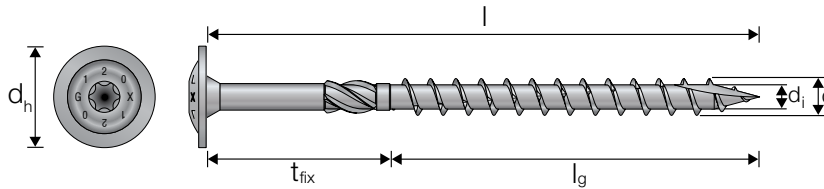

SWWZ - Characteristic Tension and Shear Capacities, Parallel (0°) to the Grain  
Glulam to Glulam GL24h

Product Reference	Thread Length L <sub>g</sub> [mm]	Max. Advised Wood Thickness t <sub>1</sub> [mm]	Tension Capacity R <sub>ax,k</sub> and Shear Capacity R <sub>v,0°:k</sub> Parallel to the Grain Depending on t <sub>1</sub> [kN]																	
			Wood Thickness t <sub>1</sub> [mm]																	
			80		90		100		115		120		140		160		180		200	
SWWZ8.0X180	80	100	5,48	5,36 4,42	5,48	5,36 4,42	5,48	5,36 4,42	-	-	-	-	-	-	-	-	-	-		
SWWZ8.0X200	80	120	5,48	5,36 4,42	5,48	5,36 4,42	5,48	5,36 4,42	5,48	5,36 4,42	5,48	5,36 4,42	-	-	-	-	-	-		
SWWZ8.0X240	80	160	5,48	5,36 4,42	5,48	5,36 4,42	5,48	5,36 4,42	5,48	5,36 4,42	5,48	5,36 4,42	5,48	5,36 4,42	5,48	5,36 4,42	-	-		
SWWZ8.0X300	80	220	5,48	5,36 4,42	5,48	5,36 4,42	5,48	5,36 4,42	5,48	5,36 4,42	5,48	5,36 4,42	5,48	5,36 4,42	5,48	5,36 4,42	5,48	5,36 4,42		
SWWZ8.0X340	80	260	5,48	5,36 4,42	5,48	5,36 4,42	5,48	5,36 4,42	5,48	5,36 4,42	5,48	5,36 4,42	5,48	5,36 4,42	5,48	5,36 4,42	5,48	5,36 4,42		
SWWZ10.0X160	80	80	6,88	7,45 6,00	-	-	-	-	-	-	-	-	-	-	-	-	-	-		
SWWZ10.0X180	80	100	6,88	7,45 6,00	6,88	7,45 6,00	6,88	7,45 6,00	-	-	-	-	-	-	-	-	-	-		
SWWZ10.0X200	80	120	6,88	7,45 6,00	6,88	7,45 6,00	6,88	7,45 6,00	6,88	7,45 6,00	6,88	7,45 6,00	-	-	-	-	-	-		
SWWZ10.0X240	80	160	6,88	7,45 6,00	6,88	7,45 6,00	6,88	7,45 6,00	6,88	7,45 6,00	6,88	7,45 6,00	6,88	7,45 6,00	6,88	7,45 6,00	-	-		

For dimensions and calculation parameters see p. 44.

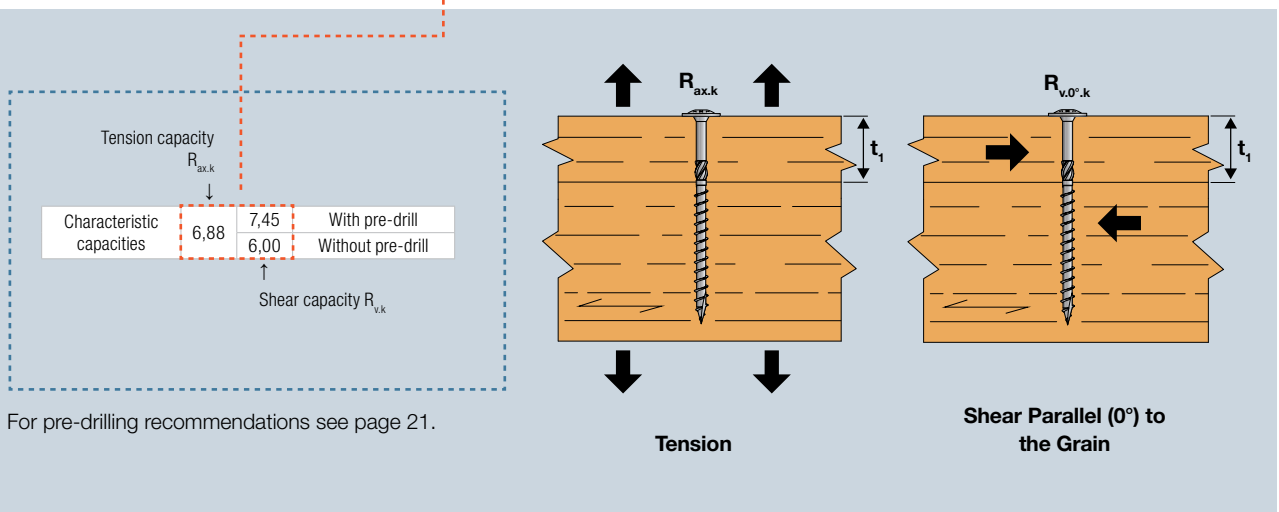

For pre-drilling recommendations see page 21.

### 3.2.1 Glulam Fastening

#### SWWZ - Characteristic Tension and Shear Capacities, Perpendicular (90°) to the Grain Glulam to Glulam GL24h

Product Reference	Thread Length $L_g$ [mm]	Max. Advised Wood Thickness $t_1$ [mm]	Tension Capacity $R_{ax,k}$ and Shear Capacity $R_{v,90°k}$ Perpendicular to the Grain Depending on $t_1$ [kN]																	
			Wood Thickness $t_1$ [mm]																	
			80		90		100		115		120		140		160		180		200	
SWWZ8.0X180	80	100	5,48	5,36 4,42	5,48	5,36 4,42	5,48	5,36 4,42	-	-	-	-	-	-	-	-	-	-	-	-
SWWZ8.0X200	80	120	5,48	5,36 4,42	5,48	5,36 4,42	5,48	5,36 4,42	5,48	5,36 4,42	5,48	5,36 4,42	-	-	-	-	-	-	-	-
SWWZ8.0X240	80	160	5,48	5,36 4,42	5,48	5,36 4,42	5,48	5,36 4,42	5,48	5,36 4,42	5,48	5,36 4,42	5,48	5,36 4,42	5,48	5,36 4,42	-	-	-	-
SWWZ8.0X300	80	220	5,48	5,36 4,42	5,48	5,36 4,42	5,48	5,36 4,42	5,48	5,36 4,42	5,48	5,36 4,42	5,48	5,36 4,42	5,48	5,36 4,42	5,48	5,36 4,42	5,48	5,36 4,42
SWWZ8.0X340	80	260	5,48	5,36 4,42	5,48	5,36 4,42	5,48	5,36 4,42	5,48	5,36 4,42	5,48	5,36 4,42	5,48	5,36 4,42	5,48	5,36 4,42	5,48	5,36 4,42	5,48	5,36 4,42
SWWZ10.0X160	80	80	6,88	7,45 6,00	-	-	-	-	-	-	-	-	-	-	-	-	-	-	-	-
SWWZ10.0X180	80	100	6,88	7,45 6,00	6,88	7,45 6,00	6,88	7,45 6,00	-	-	-	-	-	-	-	-	-	-	-	-
SWWZ10.0X200	80	120	6,88	7,45 6,00	6,88	7,45 6,00	6,88	7,45 6,00	6,88	7,45 6,00	6,88	7,45 6,00	-	-	-	-	-	-	-	-
SWWZ10.0X240	80	160	6,88	7,45 6,00	6,88	7,45 6,00	6,88	7,45 6,00	6,88	7,45 6,00	6,88	7,45 6,00	6,88	7,45 6,00	6,88	7,45 6,00	6,88	7,45 6,00	-	-

For dimensions and calculation parameters see p. 44.

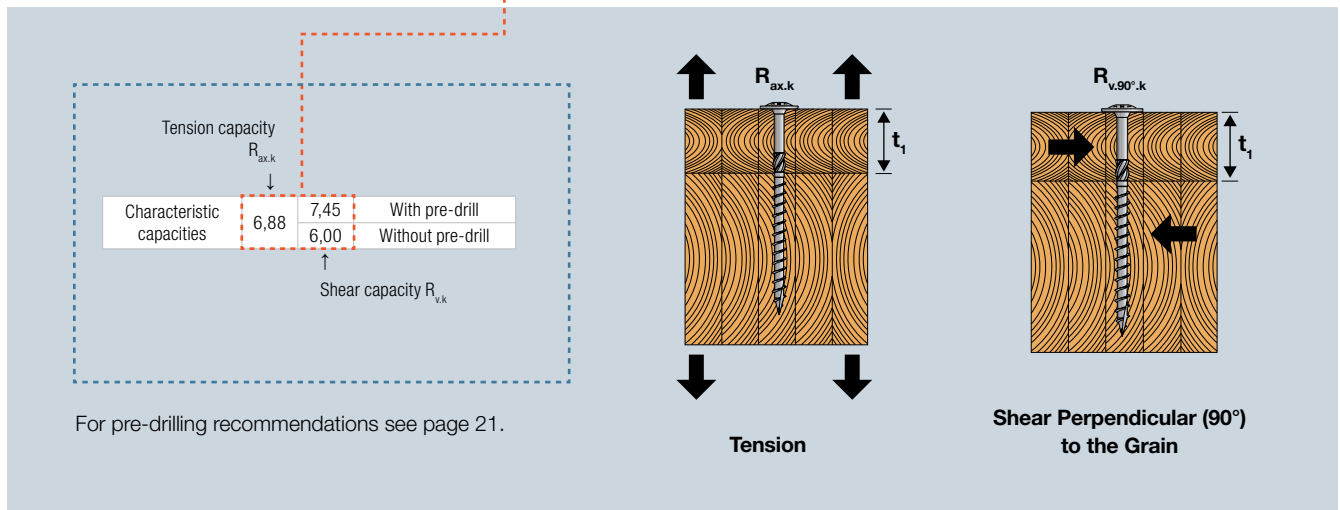

To ensure that the values in this catalog are valid, check that max. 5 mm of the thread is in the first element for partially threaded screws or that max. half the thread +/- 5 mm is in each element for the full-threaded screws.

For additional values in other configurations use Solid Wood - online dimensioning tool. Go to [solidwood.strongtie.eu](http://solidwood.strongtie.eu).

If the screw you are looking for is not shown in this table, it is because the screw cannot fulfil the requirements stated above. In this case, use Solid Wood to determine the capacity of the screw.



### 3.2.1 Glulam Fastening

#### SWW/SWWZ - Minimum distances for Screws in Shear or Combined Loads<sup>1)</sup> Glulam to Glulam GL24h

Outer Thread Diameter d [mm]	Pre-drill	Angle Between Load Direction and Grain = 0°						Angle Between Load Direction and Grain = 90°					
		a <sub>1</sub>	a <sub>2</sub>	a <sub>3,c</sub>	a <sub>3,t</sub>	a <sub>4,c</sub>	a <sub>4,t</sub>	a <sub>1</sub>	a <sub>2</sub>	a <sub>3,c</sub>	a <sub>3,t</sub>	a <sub>4,c</sub>	a <sub>4,t</sub>
6.0	With pre-drill	30	18	42	72	18	18	24	24	42	30	18	42
	Without pre-drill	72	30	60	90	30	30	30	30	60	60	30	60
8.0	With pre-drill	40	24	56	96	24	24	32	32	56	40	24	56
	Without pre-drill	96	40	80	120	40	40	40	40	80	80	40	80
10.0	With pre-drill	50	30	70	120	30	30	40	40	70	50	30	70
	Without pre-drill	120	50	100	150	50	50	50	50	100	100	50	100

<sup>1)</sup> Minimum distances comply with EN 1995-1-1 (Eurocode 5) and ETA 21/0670

<sup>2)</sup> Values given in the table are based on the  $\rho_k \leq 385 \text{ kg/m}^3$

<sup>3)</sup> Minimum distances from the unloaded edge perpendicular to the grain may be reduced to  $a_{4,c} = 3 \times d$  if the spacing parallel to the grain ( $a_1$ ) and the end distance ( $a_{3,t}$ ) is at least  $25 \times d$ .

#### SWW/SWWZ - Minimum distances for Axially Loaded Screws Glulam to Glulam GL24h

Outer Thread Diameter d [mm]	a <sub>1</sub>	a <sub>2</sub>	a <sub>3,c</sub>	a <sub>4,c</sub>
6.0	42	30	60	24
8.0	56	40	80	32
10.0	70	50	100	40

\*Valid if the applied centre distances comply with  $a_1 \times a_2 \geq 25d^2$ .  
Calculation according to EN1995-1-1:2004+A2:2014

For axially loaded screws installed perpendicular to the surface  $a_{3,t}$  and  $a_{4,t}$  are not relevant. For more info see General Introduction page 24.

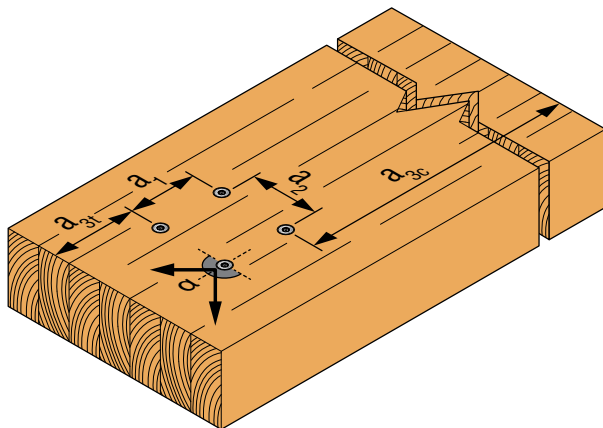

Illustration above shows angle between load direction and grain = 0°

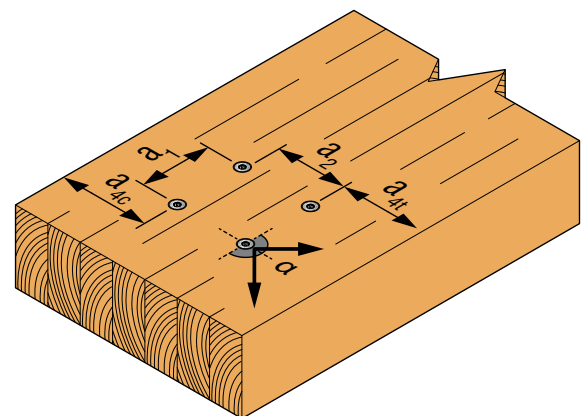

Illustration above shows angle between load direction and grain = 90°

See explanation of  $\alpha$  in General Introduction page 23.



#### Solid Wood Fastener Dimensioning Software

In just four simple steps, Solid Wood guides you through the calculation and selection of fastening solutions suitable for the specific wood structure at hand, all according to Eurocode 5 and our ETA.

Try Solid Wood today. Go to [solidwood.strongtie.eu](http://solidwood.strongtie.eu)

### 3.2.1 Glulam Fastening

## Solid-Drive™ SWC Countersunk WOOD Screw for Glulam

**Yellow Zinc Plated**  
C2 acc. to EN ISO 12944-2  
SC2 - 50 years acc. to EC5

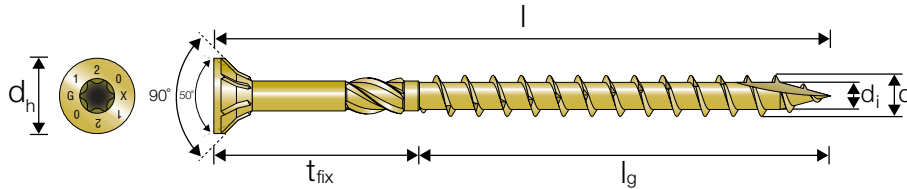

SWC - Characteristic Tension and Shear Capacities, Parallel (0°) to the Grain  
Glulam to Glulam GL24h

Product Reference	Thread Length L <sub>g</sub> [mm]	Max. Advised Wood Thickness t <sub>1</sub> [mm]	Tension Capacity R <sub>ax,k</sub> and Shear Capacity R <sub>v,0°k</sub> Parallel to the Grain Depending on t <sub>1</sub> [kN]																	
			Wood Thickness t <sub>1</sub> [mm]																	
			80		90		100		115		120		140		160		180		200	
SWC6.0X200	70	130	1,79	2,67 2,20	1,79	2,67 2,20	1,79	2,67 2,20	1,79	2,67 2,20	1,79	2,67 2,20	-	-	-	-	-	-	-	
SWC6.0X220	70	150	1,79	2,67 2,20	1,79	2,67 2,20	1,79	2,67 2,20	1,79	2,67 2,20	1,79	2,67 2,20	1,79	2,67 2,20	-	-	-	-	-	
SWC6.0X240	70	170	1,79	2,67 2,20	1,79	2,67 2,20	1,79	2,67 2,20	1,79	2,67 2,20	1,79	2,67 2,20	1,79	2,67 2,20	1,79	2,67 2,20	-	-	-	
SWC6.0X260	70	190	1,79	2,67 2,20	1,79	2,67 2,20	1,79	2,67 2,20	1,79	2,67 2,20	1,79	2,67 2,20	1,79	2,67 2,20	1,79	2,67 2,20	1,79	2,67 2,20	-	
SWC6.0X280	70	210	1,79	2,67 2,20	1,79	2,67 2,20	1,79	2,67 2,20	1,79	2,67 2,20	1,79	2,67 2,20	1,79	2,67 2,20	1,79	2,67 2,20	1,79	2,67 2,20	1,79	
SWC6.0X300	70	230	1,79	2,67 2,20	1,79	2,67 2,20	1,79	2,67 2,20	1,79	2,67 2,20	1,79	2,67 2,20	1,79	2,67 2,20	1,79	2,67 2,20	1,79	2,67 2,20	1,79	
SWC8.0X160	80	80	2,88	4,71 3,76	-	-	-	-	-	-	-	-	-	-	-	-	-	-	-	
SWC8.0X180	80	100	2,88	4,71 3,76	2,88	4,71 3,76	2,88	4,71 3,76	-	-	-	-	-	-	-	-	-	-	-	
SWC8.0X200	80	120	2,88	4,71 3,76	2,88	4,71 3,76	2,88	4,71 3,76	2,88	4,71 3,76	2,88	4,71 3,76	-	-	-	-	-	-	-	
SWC8.0X220	80	140	2,88	4,71 3,76	2,88	4,71 3,76	2,88	4,71 3,76	2,88	4,71 3,76	2,88	4,71 3,76	2,88	4,71 3,76	-	-	-	-	-	
SWC8.0X240	80	160	2,88	4,71 3,76	2,88	4,71 3,76	2,88	4,71 3,76	2,88	4,71 3,76	2,88	4,71 3,76	2,88	4,71 3,76	2,88	4,71 3,76	-	-	-	
SWC8.0X260	80	180	2,88	4,71 3,76	2,88	4,71 3,76	2,88	4,71 3,76	2,88	4,71 3,76	2,88	4,71 3,76	2,88	4,71 3,76	2,88	4,71 3,76	2,88	4,71 3,76	-	
SWC8.0X280	80	200	2,88	4,71 3,76	2,88	4,71 3,76	2,88	4,71 3,76	2,88	4,71 3,76	2,88	4,71 3,76	2,88	4,71 3,76	2,88	4,71 3,76	2,88	4,71 3,76	2,88	
SWC6.0X300	80	220	2,88	4,71 3,76	2,88	4,71 3,76	2,88	4,71 3,76	2,88	4,71 3,76	2,88	4,71 3,76	2,88	4,71 3,76	2,88	4,71 3,76	2,88	4,71 3,76	2,88	
SWC8.0X320	80	240	2,88	4,71 3,76	2,88	4,71 3,76	2,88	4,71 3,76	2,88	4,71 3,76	2,88	4,71 3,76	2,88	4,71 3,76	2,88	4,71 3,76	2,88	4,71 3,76	2,88	
SWC8.0X340	80	260	2,88	4,71 3,76	2,88	4,71 3,76	2,88	4,71 3,76	2,88	4,71 3,76	2,88	4,71 3,76	2,88	4,71 3,76	2,88	4,71 3,76	2,88	4,71 3,76	2,88	
SWC8.0X360	80	280	2,88	4,71 3,76	2,88	4,71 3,76	2,88	4,71 3,76	2,88	4,71 3,76	2,88	4,71 3,76	2,88	4,71 3,76	2,88	4,71 3,76	2,88	4,71 3,76	2,88	
SWC8.0X380	80	300	2,88	4,71 3,76	2,88	4,71 3,76	2,88	4,71 3,76	2,88	4,71 3,76	2,88	4,71 3,76	2,88	4,71 3,76	2,88	4,71 3,76	2,88	4,71 3,76	2,88	
SWC8.0X400	80	320	2,88	4,71 3,76	2,88	4,71 3,76	2,88	4,71 3,76	2,88	4,71 3,76	2,88	4,71 3,76	2,88	4,71 3,76	2,88	4,71 3,76	2,88	4,71 3,76	2,88	

Table continues on next page.

### 3.2.1 Glulam Fastening

#### SWC - Characteristic Tension and Shear Capacities, Parallel (0°) to the Grain Glulam to Glulam GL24h (continued)

Product Reference	Thread Length $L_g$ [mm]	Max. Advised Wood Thickness $t_1$ [mm]	Tension Capacity $R_{ax,k}$ and Shear Capacity $R_{v,0^\circ,k}$ Parallel to the Grain Depending on $t_1$ [kN]																
			Wood Thickness $t_1$ [mm]																
			80	90	100	115	120	140	160	180	200	80	90	100	115	120	140	160	180
SWC10.0X160	80	80	3,83	6,69 5,23	-	-	-	-	-	-	-	-	-	-	-	-	-	-	-
SWC10.0X180	80	100	3,83	6,69 5,23	3,83	6,69 5,23	3,83	6,69 5,23	-	-	-	-	-	-	-	-	-	-	-
SWC10.0X200	80	120	3,83	6,69 5,23	3,83	6,69 5,23	3,83	6,69 5,23	3,83	6,69 5,23	3,83	6,69 5,23	-	-	-	-	-	-	-
SWC10.0X220	80	140	3,83	6,69 5,23	3,83	6,69 5,23	3,83	6,69 5,23	3,83	6,69 5,23	3,83	6,69 5,23	3,83	6,69 5,23	-	-	-	-	-
SWC10.0X240	80	160	3,83	6,69 5,23	3,83	6,69 5,23	3,83	6,69 5,23	3,83	6,69 5,23	3,83	6,69 5,23	3,83	6,69 5,23	3,83	6,69 5,23	-	-	-
SWC10.0X260	80	180	3,83	6,69 5,23	3,83	6,69 5,23	3,83	6,69 5,23	3,83	6,69 5,23	3,83	6,69 5,23	3,83	6,69 5,23	3,83	6,69 5,23	3,83	6,69 5,23	-
SWC10.0X280	80	200	3,83	6,69 5,23	3,83	6,69 5,23	3,83	6,69 5,23	3,83	6,69 5,23	3,83	6,69 5,23	3,83	6,69 5,23	3,83	6,69 5,23	3,83	6,69 5,23	3,83
SWC10.0X300	80	220	3,83	6,69 5,23	3,83	6,69 5,23	3,83	6,69 5,23	3,83	6,69 5,23	3,83	6,69 5,23	3,83	6,69 5,23	3,83	6,69 5,23	3,83	6,69 5,23	3,83
SWC10.0X320	80	240	3,83	6,69 5,23	3,83	6,69 5,23	3,83	6,69 5,23	3,83	6,69 5,23	3,83	6,69 5,23	3,83	6,69 5,23	3,83	6,69 5,23	3,83	6,69 5,23	3,83
SWC10.0X340	80	260	3,83	6,69 5,23	3,83	6,69 5,23	3,83	6,69 5,23	3,83	6,69 5,23	3,83	6,69 5,23	3,83	6,69 5,23	3,83	6,69 5,23	3,83	6,69 5,23	3,83
SWC10.0X360	80	280	3,83	6,69 5,23	3,83	6,69 5,23	3,83	6,69 5,23	3,83	6,69 5,23	3,83	6,69 5,23	3,83	6,69 5,23	3,83	6,69 5,23	3,83	6,69 5,23	3,83
SWC10.0X380	80	300	3,83	6,69 5,23	3,83	6,69 5,23	3,83	6,69 5,23	3,83	6,69 5,23	3,83	6,69 5,23	3,83	6,69 5,23	3,83	6,69 5,23	3,83	6,69 5,23	3,83
SWC10.0X400	80	320	3,83	6,69 5,23	3,83	6,69 5,23	3,83	6,69 5,23	3,83	6,69 5,23	3,83	6,69 5,23	3,83	6,69 5,23	3,83	6,69 5,23	3,83	6,69 5,23	3,83

For dimensions and calculation parameters see p. 48.

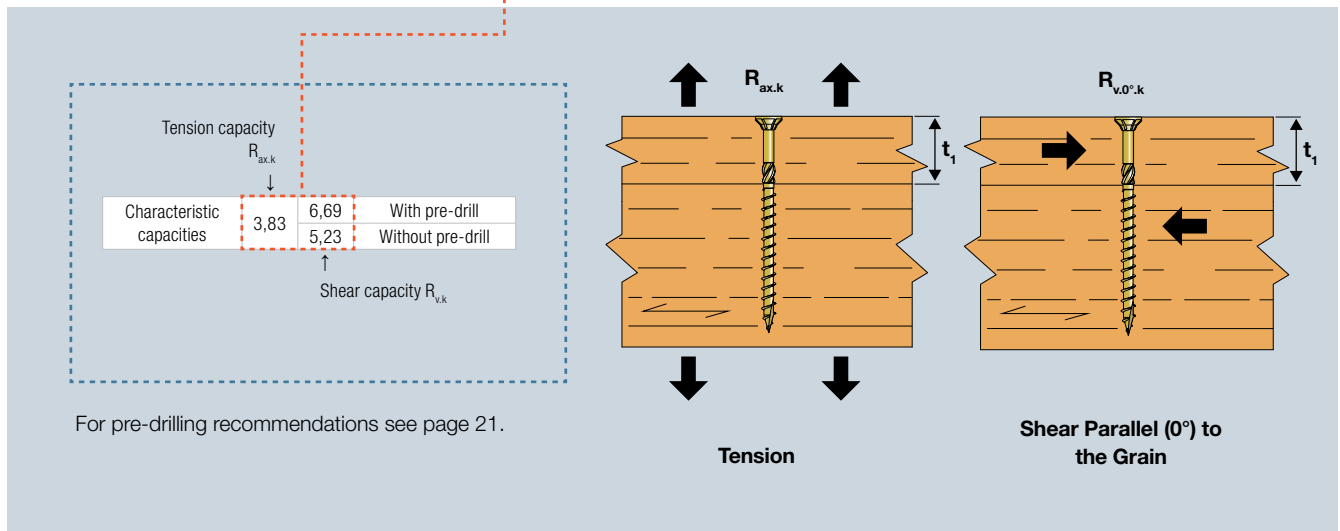

To ensure that the values in this catalog are valid, check that max. 5 mm of the thread is in the first element for partially threaded screws or that max. half the thread +/- 5 mm is in each element for the full-threaded screws.

For additional values in other configurations use Solid Wood - online dimensioning tool. Go to [solidwood.strongtie.eu](http://solidwood.strongtie.eu).

If the screw you are looking for is not shown in this table, it is because the screw cannot fulfil the requirements stated above. In this case, use Solid Wood to determine the capacity of the screw.

### 3.2.1 Glulam Fastening

SWC - Characteristic Tension and Shear Capacities, Perpendicular (90°) to the Grain  
Glulam to Glulam GL24h

Product Reference	Thread Length $L_g$ [mm]	Max. Advised Wood Thickness $t_f$ [mm]	Tension Capacity $R_{ax,k}$ and Shear Capacity $R_{v,90°k}$ Perpendicular to the Grain Depending on $t_f$ [kN]																	
			Wood Thickness $t_f$ [mm]																	
			80		90		100		115		120		140		160		180		200	
SWC6.0X200	70	130	1,79	2,67 2,20	1,79	2,67 2,20	1,79	2,67 2,20	1,79	2,67 2,20	1,79	2,67 2,20	-	-	-	-	-	-	-	
SWC6.0X220	70	150	1,79	2,67 2,20	1,79	2,67 2,20	1,79	2,67 2,20	1,79	2,67 2,20	1,79	2,67 2,20	1,79	2,67 2,20	-	-	-	-	-	
SWC6.0X240	70	170	1,79	2,67 2,20	1,79	2,67 2,20	1,79	2,67 2,20	1,79	2,67 2,20	1,79	2,67 2,20	1,79	2,67 2,20	1,79	2,67 2,20	-	-	-	
SWC6.0X260	70	190	1,79	2,67 2,20	1,79	2,67 2,20	1,79	2,67 2,20	1,79	2,67 2,20	1,79	2,67 2,20	1,79	2,67 2,20	1,79	2,67 2,20	1,79	2,67 2,20	-	
SWC6.0X280	70	210	1,79	2,67 2,20	1,79	2,67 2,20	1,79	2,67 2,20	1,79	2,67 2,20	1,79	2,67 2,20	1,79	2,67 2,20	1,79	2,67 2,20	1,79	2,67 2,20	1,79	
SWC6.0X300	70	230	1,79	2,67 2,20	1,79	2,67 2,20	1,79	2,67 2,20	1,79	2,67 2,20	1,79	2,67 2,20	1,79	2,67 2,20	1,79	2,67 2,20	1,79	2,67 2,20	1,79	
SWC8.0X160	80	80	2,88	4,71 3,76	-	-	-	-	-	-	-	-	-	-	-	-	-	-	-	
SWC8.0X180	80	100	2,88	4,71 3,76	2,88	4,71 3,76	2,88	4,71 3,76	-	-	-	-	-	-	-	-	-	-	-	
SWC8.0X200	80	120	2,88	4,71 3,76	2,88	4,71 3,76	2,88	4,71 3,76	2,88	4,71 3,76	2,88	4,71 3,76	-	-	-	-	-	-	-	
SWC8.0X220	80	140	2,88	4,71 3,76	2,88	4,71 3,76	2,88	4,71 3,76	2,88	4,71 3,76	2,88	4,71 3,76	2,88	4,71 3,76	-	-	-	-	-	
SWC8.0X240	80	160	2,88	4,71 3,76	2,88	4,71 3,76	2,88	4,71 3,76	2,88	4,71 3,76	2,88	4,71 3,76	2,88	4,71 3,76	2,88	4,71 3,76	-	-	-	
SWC8.0X260	80	180	2,88	4,71 3,76	2,88	4,71 3,76	2,88	4,71 3,76	2,88	4,71 3,76	2,88	4,71 3,76	2,88	4,71 3,76	2,88	4,71 3,76	2,88	4,71 3,76	-	
SWC8.0X280	80	200	2,88	4,71 3,76	2,88	4,71 3,76	2,88	4,71 3,76	2,88	4,71 3,76	2,88	4,71 3,76	2,88	4,71 3,76	2,88	4,71 3,76	2,88	4,71 3,76	2,88	
SWC6.0X300	80	220	2,88	4,71 3,76	2,88	4,71 3,76	2,88	4,71 3,76	2,88	4,71 3,76	2,88	4,71 3,76	2,88	4,71 3,76	2,88	4,71 3,76	2,88	4,71 3,76	2,88	
SWC8.0X320	80	240	2,88	4,71 3,76	2,88	4,71 3,76	2,88	4,71 3,76	2,88	4,71 3,76	2,88	4,71 3,76	2,88	4,71 3,76	2,88	4,71 3,76	2,88	4,71 3,76	2,88	
SWC8.0X340	80	260	2,88	4,71 3,76	2,88	4,71 3,76	2,88	4,71 3,76	2,88	4,71 3,76	2,88	4,71 3,76	2,88	4,71 3,76	2,88	4,71 3,76	2,88	4,71 3,76	2,88	
SWC8.0X360	80	280	2,88	4,71 3,76	2,88	4,71 3,76	2,88	4,71 3,76	2,88	4,71 3,76	2,88	4,71 3,76	2,88	4,71 3,76	2,88	4,71 3,76	2,88	4,71 3,76	2,88	
SWC8.0X380	80	300	2,88	4,71 3,76	2,88	4,71 3,76	2,88	4,71 3,76	2,88	4,71 3,76	2,88	4,71 3,76	2,88	4,71 3,76	2,88	4,71 3,76	2,88	4,71 3,76	2,88	
SWC8.0X400	80	320	2,88	4,71 3,76	2,88	4,71 3,76	2,88	4,71 3,76	2,88	4,71 3,76	2,88	4,71 3,76	2,88	4,71 3,76	2,88	4,71 3,76	2,88	4,71 3,76	2,88	

Table continues on next page.

### 3.2.1 Glulam Fastening

#### SWC - Characteristic Tension and Shear Capacities, Perpendicular (90°) to the Grain Glulam to Glulam GL24h (continued)

Product Reference	Thread Length $L_g$ [mm]	Max. Advised Wood Thickness $t_1$ [mm]	Tension Capacity $R_{ax,k}$ and Shear Capacity $R_{v,90^\circ,k}$ Perpendicular to the Grain Depending on $t_1$ [kN]																
			Wood Thickness $t_1$ [mm]																
			80	90	100	115	120	140	160	180	200	80	90	100	115	120	140	160	180
SWC10.0X160	80	80	3,83	6,69	-	-	-	-	-	-	-	-	-	-	-	-	-	-	-
SWC10.0X180	80	100	3,83	6,69	3,83	6,69	3,83	6,69	-	-	-	-	-	-	-	-	-	-	-
SWC10.0X200	80	120	3,83	6,69	3,83	6,69	3,83	6,69	3,83	6,69	3,83	6,69	-	-	-	-	-	-	-
SWC10.0X220	80	140	3,83	6,69	3,83	6,69	3,83	6,69	3,83	6,69	3,83	6,69	3,83	6,69	-	-	-	-	-
SWC10.0X240	80	160	3,83	6,69	3,83	6,69	3,83	6,69	3,83	6,69	3,83	6,69	3,83	6,69	3,83	6,69	-	-	-
SWC10.0X260	80	180	3,83	6,69	3,83	6,69	3,83	6,69	3,83	6,69	3,83	6,69	3,83	6,69	3,83	6,69	3,83	6,69	-
SWC10.0X280	80	200	3,83	6,69	3,83	6,69	3,83	6,69	3,83	6,69	3,83	6,69	3,83	6,69	3,83	6,69	3,83	6,69	3,83
SWC10.0X300	80	220	3,83	6,69	3,83	6,69	3,83	6,69	3,83	6,69	3,83	6,69	3,83	6,69	3,83	6,69	3,83	6,69	3,83
SWC10.0X320	80	240	3,83	6,69	3,83	6,69	3,83	6,69	3,83	6,69	3,83	6,69	3,83	6,69	3,83	6,69	3,83	6,69	3,83
SWC10.0X340	80	260	3,83	6,69	3,83	6,69	3,83	6,69	3,83	6,69	3,83	6,69	3,83	6,69	3,83	6,69	3,83	6,69	3,83
SWC10.0X360	80	280	3,83	6,69	3,83	6,69	3,83	6,69	3,83	6,69	3,83	6,69	3,83	6,69	3,83	6,69	3,83	6,69	3,83
SWC10.0X380	80	300	3,83	6,69	3,83	6,69	3,83	6,69	3,83	6,69	3,83	6,69	3,83	6,69	3,83	6,69	3,83	6,69	3,83
SWC10.0X400	80	320	3,83	6,69	3,83	6,69	3,83	6,69	3,83	6,69	3,83	6,69	3,83	6,69	3,83	6,69	3,83	6,69	3,83

For dimensions and calculation parameters see p. 48.

Tension capacity  $R_{ax,k}$

Characteristic capacities	3,83	6,69	With pre-drill
		5,23	Without pre-drill

Shear capacity  $R_{v,k}$

**Tension**

**Shear Perpendicular (90°) to the Grain**

For pre-drilling recommendations see page 21.

To ensure that the values in this catalog are valid, check that max. 5 mm of the thread is in the first element for partially threaded screws or that max. half the thread +/- 5 mm is in each element for the full-threaded screws.

For additional values in other configurations use Solid Wood - online dimensioning tool. Go to [solidwood.strongtie.eu](http://solidwood.strongtie.eu).

If the screw you are looking for is not shown in this table, it is because the screw cannot fulfil the requirements stated above. In this case, use Solid Wood to determine the capacity of the screw.

### 3.2.1 Glulam Fastening

#### SWC - Minimum distances for Screws in Shear or Combined Loads<sup>1)</sup> Glulam to Glulam GL24h

Outer Thread Diameter d [mm]	Pre-drill	Angle Between Load Direction and Grain = 0°						Angle Between Load Direction and Grain = 90°					
		a <sub>1</sub>	a <sub>2</sub>	a <sub>3,c</sub>	a <sub>3,t</sub>	a <sub>4,c</sub>	a <sub>4,t</sub>	a <sub>1</sub>	a <sub>2</sub>	a <sub>3,c</sub>	a <sub>3,t</sub>	a <sub>4,c</sub>	a <sub>4,t</sub>
6.0	With pre-drill	30	18	42	72	18	18	24	24	42	30	18	42
	Without pre-drill	72	30	60	90	30	30	30	30	60	60	30	60
8.0	With pre-drill	40	24	56	96	24	24	32	32	56	40	24	56
	Without pre-drill	96	40	80	120	40	40	40	40	80	80	40	80
10.0	With pre-drill	50	30	70	120	30	30	40	40	70	50	30	70
	Without pre-drill	120	50	100	150	50	50	50	50	100	100	50	100

<sup>1)</sup> Minimum distances comply with EN 1995-1-1 (Eurocode 5) and ETA 21/0670

<sup>2)</sup> Values given in the table are based on the  $\rho_k \leq 385 \text{ kg/m}^3$

<sup>3)</sup> Minimum distances from the unloaded edge perpendicular to the grain may be reduced to  $a_{4,c} = 3 \times d$  if the spacing parallel to the grain ( $a_1$ ) and the end distance ( $a_{3,t}$ ) is at least  $25 \times d$ .

#### SWC - Minimum distances for Axially Loaded Screws Glulam to Glulam GL24h

Outer Thread Diameter d [mm]	a <sub>1</sub>	a <sub>2</sub>	a <sub>3,c</sub>	a <sub>4,c</sub>
6.0	42	30	60	24
8.0	56	40	80	32
10.0	70	50	100	40

\*Valid if the applied centre distances comply with  $a_1 \times a_2 \geq 25d^2$ .  
Calculation according to EN1995-1-1:2004+A2:2014

For axially loaded screws installed perpendicular to the surface  $a_{3,t}$  and  $a_{4,t}$  are not relevant. For more info see General Introduction page 24.

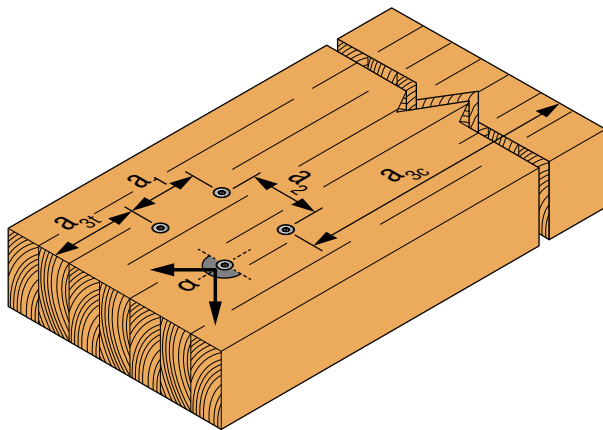

Illustration above shows angle between load direction and grain = 0°

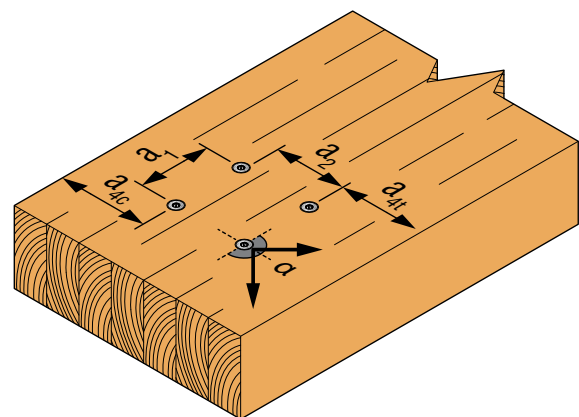

Illustration above shows angle between load direction and grain = 90°

See explanation of  $\alpha$  in General Introduction page 23.



#### Solid Wood Fastener Dimensioning Software

In just four simple steps, Solid Wood guides you through the calculation and selection of fastening solutions suitable for the specific wood structure at hand, all according to Eurocode 5 and our ETA.

Try Solid Wood today. Go to [solidwood.strongtie.eu](http://solidwood.strongtie.eu)



### 3.2.1 Glulam Fastening

## Solid-Drive™ SWD Double-Threaded WOOD Screw for Glulam

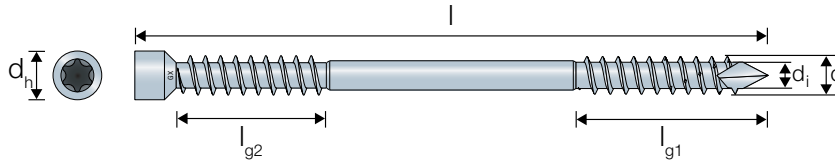
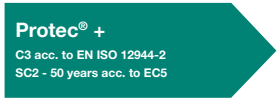

SWD - Characteristic Tension and Shear Capacities, Parallel (0°) to the Grain  
Glulam to Glulam GL24h

Product Reference	Thread Length $L_g$ [mm]	Max. Advised Wood Thickness $t_1$ [mm]	Tension Capacity $R_{ax,k}$ and Shear Capacity $R_{v,0°k}$ Parallel to the Grain Depending on $t_1$ [kN]															
			Wood Thickness $t_1$ [mm]															
			80		90		100		115		120		140		160		180	
SWD6.5X130	40	90	3,22	3,31 2,76	3,22	3,31 2,75	-	-	-	-	-	-	-	-	-	-	-	-
SWD6.5X160	65	95	5,62	3,91 3,36	5,62	3,91 3,36	5,62	3,91 3,36	-	-	-	-	-	-	-	-	-	-
SWD6.5X190	80	110	7,06	4,27 3,73	7,06	4,27 3,73	7,06	4,27 3,73	7,06	4,27 3,73	-	-	-	-	-	-	-	-
SWD6.5X220	95	125	7,69	4,63 3,92	8,51	4,63 3,92	8,51	4,63 3,92	8,51	4,63 3,92	8,51	4,63 3,92	-	-	-	-	-	-
SWD8.0X130	40	90	3,56	4,95 3,79	3,56	4,81 3,43	-	-	-	-	-	-	-	-	-	-	-	-
SWD8.0X160	65	95	6,39	5,66 4,69	6,39	5,66 4,69	6,39	5,66 4,69	-	-	-	-	-	-	-	-	-	-
SWD8.0X190	80	110	8,09	6,08 5,12	8,09	6,08 5,12	8,09	6,08 5,12	8,09	6,08 5,12	-	-	-	-	-	-	-	-
SWD8.0X220	95	125	9,05	6,50 5,54	9,78	6,50 5,54	9,78	6,50 5,54	9,78	6,50 5,54	9,78	6,50 5,54	-	-	-	-	-	-
SWD8.0X245	107	138	9,05	6,86 5,90	10,18	6,86 5,90	11,20	6,86 5,90	11,20	6,86 5,90	11,20	6,86 5,90	11,20	6,86 5,90	-	-	-	-
SWD8.0X275	107	168	9,05	6,86 5,90	10,18	6,86 5,90	11,20	6,86 5,90	11,20	6,86 5,90	11,20	6,86 5,90	11,20	6,86 5,90	11,20	6,86 5,90	-	-
SWD8.0X300	135	165	9,05	7,64 6,19	10,18	7,64 6,19	11,31	7,64 6,19	13,01	7,64 6,19	13,57	7,64 6,19	14,31	7,64 6,19	14,31	7,64 6,19	-	-
SWD8.0X330	135	195	9,05	7,64 6,19	10,18	7,64 6,19	11,31	7,64 6,19	13,01	7,64 6,19	13,57	7,64 6,19	14,31	7,64 6,19	14,31	7,64 6,19	14,31	7,64 6,19

For dimensions and calculation parameters see p. 50.

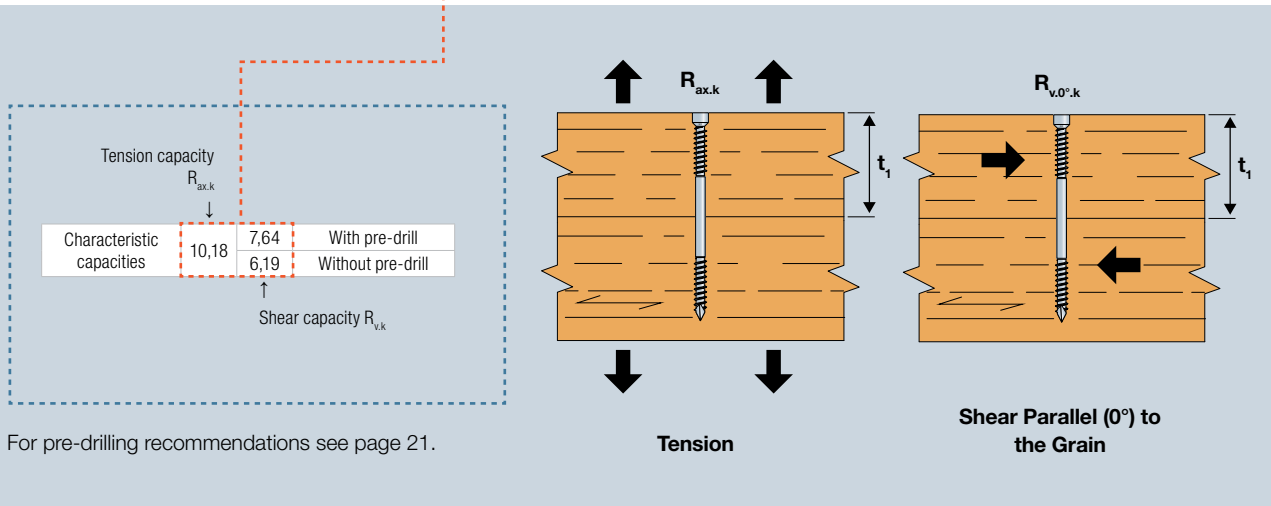

C-F-EU-TG-2023-02 (2<sup>nd</sup> Edition) © 2023 SIMPSON STRONG-TIE COMPANY INC.

Glulam

### 3.2.1 Glulam Fastening

#### SWD - Characteristic Tension and Shear Capacities, Perpendicular (90°) to the Grain Glulam to Glulam GL24h

Product Reference	Thread Length $L_g$ [mm]	Max. Advised Wood Thickness $t_1$ [mm]	Tension Capacity $R_{ax,k}$ and Shear Capacity $R_{v,90°k}$ Perpendicular to the Grain Depending on $t_1$ [kN]																	
			Wood Thickness $t_1$ [mm]																	
			80	90	100	115	120	140	160	180	200	80	90	100	115	120	140	160	180	200
SWD6.5X130	40	90	3,22	3,31 2,76	3,22	3,31 2,75	-	-	-	-	-	-	-	-	-	-	-	-	-	-
SWD6.5X160	65	95	5,62	3,91 3,36	5,62	3,91 3,36	5,62	3,91 3,36	-	-	-	-	-	-	-	-	-	-	-	-
SWD6.5X190	80	110	7,06	4,27 3,73	7,06	4,27 3,73	7,06	4,27 3,73	7,06	4,27 3,73	-	-	-	-	-	-	-	-	-	-
SWD6.5X220	95	125	7,69	4,63 3,92	8,51	4,63 3,92	8,51	4,63 3,92	8,51	4,63 3,92	8,51	4,63 3,92	-	-	-	-	-	-	-	-
SWD8.0X130	40	90	3,56	4,95 3,79	3,56	4,81 3,43	-	-	-	-	-	-	-	-	-	-	-	-	-	-
SWD8.0X160	65	95	6,39	5,66 4,69	6,39	5,66 4,69	6,39	5,66 4,69	-	-	-	-	-	-	-	-	-	-	-	-
SWD8.0X190	80	110	8,09	6,08 5,12	8,09	6,08 5,12	8,09	6,08 5,12	8,09	6,08 5,12	-	-	-	-	-	-	-	-	-	-
SWD8.0X220	95	125	9,05	6,50 5,54	9,78	6,50 5,54	9,78	6,50 5,54	9,78	6,50 5,54	9,78	6,50 5,54	-	-	-	-	-	-	-	-
SWD8.0X245	107	138	9,05	6,86 5,90	10,18	6,86 5,90	11,20	6,86 5,90	11,20	6,86 5,90	11,20	6,86 5,90	11,20	6,86 5,90	-	-	-	-	-	-
SWD8.0X275	107	168	9,05	6,86 5,90	10,18	6,86 5,90	11,20	6,86 5,90	11,20	6,86 5,90	11,20	6,86 5,90	11,20	6,86 5,90	11,20	6,86 5,90	-	-	-	-
SWD8.0X300	135	165	9,05	7,64 6,19	10,18	7,64 6,19	11,31	7,64 6,19	13,01	7,64 6,19	13,57	7,64 6,19	14,31	7,64 6,19	14,31	7,64 6,19	-	-	-	-
SWD8.0X330	135	195	9,05	7,64 6,19	10,18	7,64 6,19	11,31	7,64 6,19	13,01	7,64 6,19	13,57	7,64 6,19	14,31	7,64 6,19	14,31	7,64 6,19	14,31	7,64 6,19	14,31	7,64 6,19

For dimensions and calculation parameters see p. 50.

Glulam

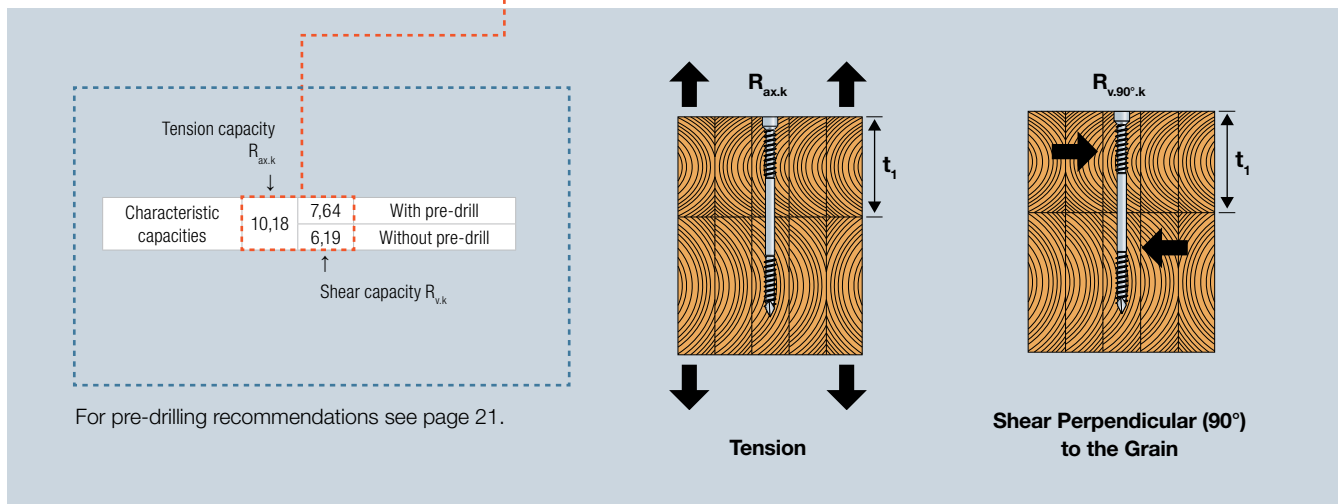

For pre-drilling recommendations see page 21.

To ensure that the values in this catalog are valid, check that max. 5 mm of the thread is in the first element for partially threaded screws or that max. half the thread +/- 5 mm is in each element for the full-threaded screws.

For additional values in other configurations use Solid Wood - online dimensioning tool. Go to [solidwood.strongtie.eu](http://solidwood.strongtie.eu).

If the screw you are looking for is not shown in this table, it is because the screw cannot fulfil the requirements stated above. In this case, use Solid Wood to determine the capacity of the screw.

### 3.2.1 Glulam Fastening

#### SWD - Minimum distances for Screws in Shear or Combined Loads<sup>1)</sup> Glulam to Glulam GL24h

Outer Thread Diameter d [mm]	Pre-drill	Angle Between Load Direction and Grain = 0°						Angle Between Load Direction and Grain = 90°					
		a <sub>1</sub>	a <sub>2</sub>	a <sub>3,c</sub>	a <sub>3,t</sub>	a <sub>4,c</sub>	a <sub>4,t</sub>	a <sub>1</sub>	a <sub>2</sub>	a <sub>3,c</sub>	a <sub>3,t</sub>	a <sub>4,c</sub>	a <sub>4,t</sub>
6.5	With pre-drill	33	20	46	78	20	20	26	26	46	33	20	46
	Without pre-drill	78	33	65	98	33	33	33	33	65	65	33	65
8.0	With pre-drill	40	24	56	96	24	24	32	32	56	40	24	56
	Without pre-drill	96	40	80	120	40	40	40	40	80	80	40	80

<sup>1)</sup> Minimum distances comply with EN 1995-1-1 (Eurocode 5) and ETA 21/0670

<sup>2)</sup> Values given in the table are based on the  $\rho_k \leq 385 \text{ kg/m}^3$

<sup>3)</sup> Minimum distances from the unloaded edge perpendicular to the grain may be reduced to  $a_{4,c} = 3 \times d$  if the spacing parallel to the grain ( $a_1$ ) and the end distance ( $a_{3,t}$ ) is at least  $25 \times d$ .

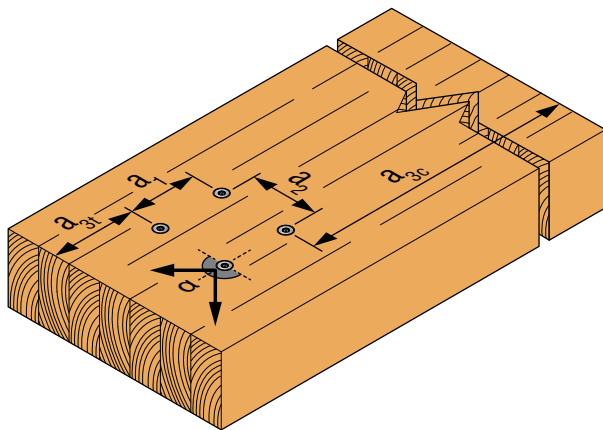

Illustration above shows angle between load direction and grain = 0°

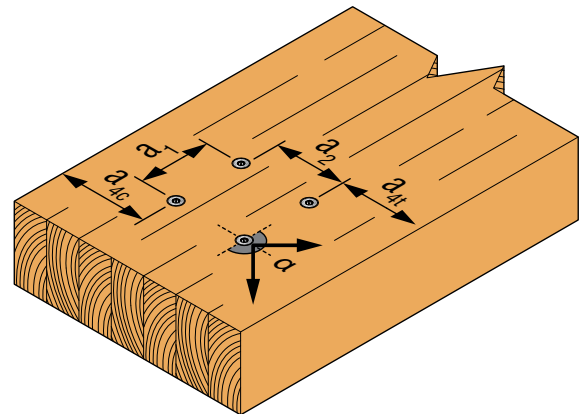

Illustration above shows angle between load direction and grain = 90°

See explanation of  $\alpha$  in General Introduction page 23.

#### SWD - Minimum distances for Axially Loaded Screws Glulam to Glulam GL24h

Outer Thread Diameter d [mm]	a <sub>1</sub>	a <sub>2</sub>	a <sub>1,cg</sub>	a <sub>2,cg</sub>
6.5	65	20	52	20
8.0	80	24	64	24

\*Valid if the applied centre distances comply with  $a_1 \times a_2 \geq 25d^2$ .  
Calculation according to EN1995-1-1:2004+A2:2014

For axially loaded screws installed perpendicular to the surface  $a_{3,t}$  and  $a_{4,t}$  are not relevant. For more info see General Introduction page 24.

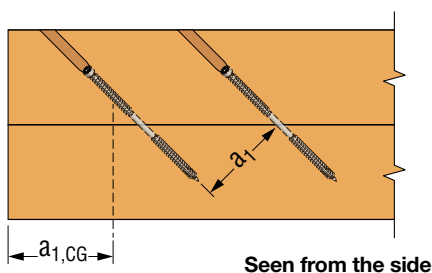

Seen from the side

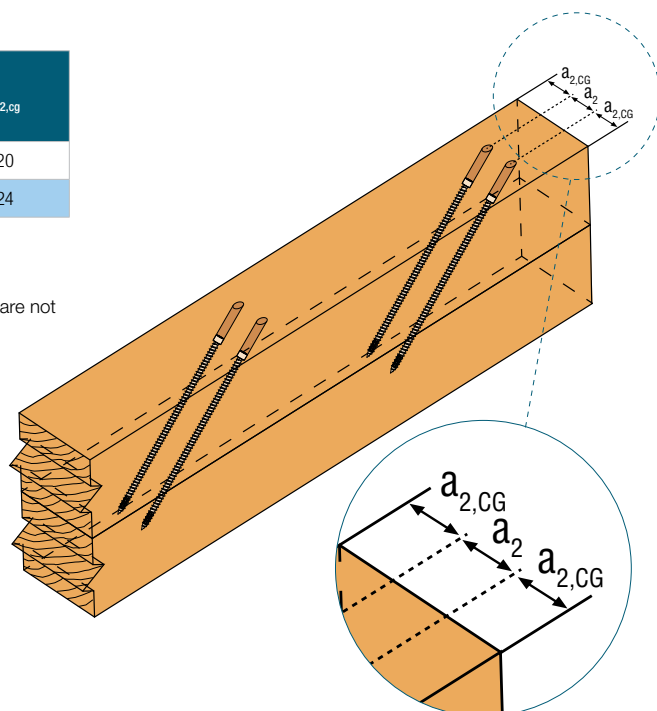

### 3.2.1 Glulam Fastening

## Solid-Drive™ SSH Hex-Head WOOD Screw for Glulam

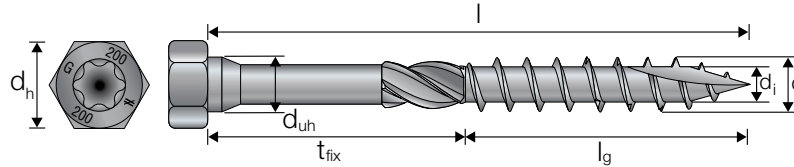
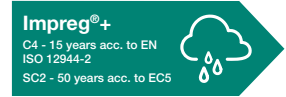

SSH - Characteristic Tension and Shear Capacities, Parallel (0°) to the Grain  
Glulam to Glulam GL24h

Product Reference	Thread Length $L_g$ [mm]	Max. Advised Wood Thickness $t_1$ [mm]	Tension Capacity $R_{ax,k}$ and Shear Capacity $R_{v,0^\circ,k}$ Parallel to the Grain Depending on $t_1$ [kN]															
			Wood Thickness $t_1$ [mm]															
			80		90		100		115		120		140		160		180	
SSH8.0X200	110	90	3,56	4,83 3,90	3,56	4,83 3,90	-	-	-	-	-	-	-	-	-	-	-	-
SSH8.0X240	110	130	3,56	4,83 3,90	3,56	4,83 3,90	3,56	4,83 3,90	3,56	4,83 3,90	3,56	4,83 3,90	-	-	-	-	-	-
SSH8.0X260	110	150	3,56	4,83 3,90	3,56	4,83 3,90	3,56	4,83 3,90	3,56	4,83 3,90	3,56	4,83 3,90	3,56	4,83 3,90	-	-	-	-
SSH8.0X280	110	170	3,56	4,83 3,90	3,56	4,83 3,90	3,56	4,83 3,90	3,56	4,83 3,90	3,56	4,83 3,90	3,56	4,83 3,90	3,56	4,83 3,90	-	-
SSH8.0X300	110	190	3,56	4,83 3,90	3,56	4,83 3,90	3,56	4,83 3,90	3,56	4,83 3,90	3,56	4,83 3,90	3,56	4,83 3,90	3,56	4,83 3,90	3,56	4,83 3,90
SSH10.0X200	110	90	4,69	6,56 5,20	4,69	6,56 5,20	-	-	-	-	-	-	-	-	-	-	-	-
SSH10.0X220	125	95	4,69	6,56 5,20	4,69	6,56 5,20	4,69	6,56 5,20	-	-	-	-	-	-	-	-	-	-
SSH10.0X240	125	115	4,69	6,56 5,20	4,69	6,56 5,20	4,69	6,56 5,20	4,69	6,56 5,20	4,69	6,56 5,20	-	-	-	-	-	-
SSH10.0X280	125	155	4,69	6,56 5,20	4,69	6,56 5,20	4,69	6,56 5,20	4,69	6,56 5,20	4,69	6,56 5,20	4,69	6,56 5,20	4,69	6,56 5,20	-	-

Table continues on next page.

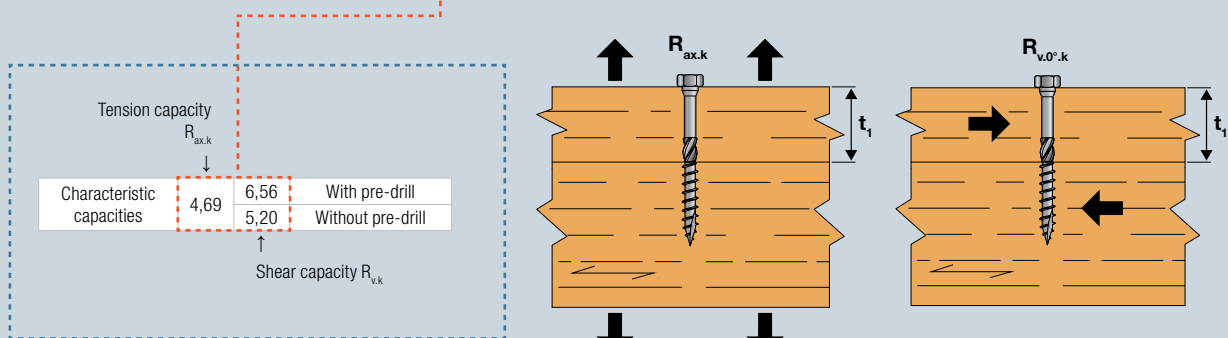

For pre-drilling recommendations see page 21.

### 3.2.1 Glulam Fastening

#### SSH - Characteristic Tension and Shear Capacities, Perpendicular (90°) to the Grain Glulam to Glulam GL24h

Product Reference	Thread Length $L_g$ [mm]	Max. Advised Wood Thickness $t_1$ [mm]	Tension Capacity $R_{ax,k}$ and Shear Capacity $R_{v,90^\circ,k}$ Perpendicular to the Grain Depending on $t_1$ [kN]																	
			Wood Thickness $t_1$ [mm]																	
			80		90		100		115		120		140		160		180		200	
SSH8.OX200	110	90	3,56	4,83 3,90	3,56	4,83 3,90	-	-	-	-	-	-	-	-	-	-	-	-	-	-
SSH8.OX240	110	130	3,56	4,83 3,90	3,56	4,83 3,90	3,56	4,83 3,90	3,56	4,83 3,90	3,56	4,83 3,90	-	-	-	-	-	-	-	-
SSH8.OX260	110	150	3,56	4,83 3,90	3,56	4,83 3,90	3,56	4,83 3,90	3,56	4,83 3,90	3,56	4,83 3,90	3,56	4,83 3,90	-	-	-	-	-	-
SSH8.OX280	110	170	3,56	4,83 3,90	3,56	4,83 3,90	3,56	4,83 3,90	3,56	4,83 3,90	3,56	4,83 3,90	3,56	4,83 3,90	3,56	4,83 3,90	-	-	-	-
SSH8.OX300	110	190	3,56	4,83 3,90	3,56	4,83 3,90	3,56	4,83 3,90	3,56	4,83 3,90	3,56	4,83 3,90	3,56	4,83 3,90	3,56	4,83 3,90	3,56	4,83 3,90	-	-
SSH10.OX200	110	90	4,69	6,56 5,20	4,69	6,56 5,20	-	-	-	-	-	-	-	-	-	-	-	-	-	-
SSH10.OX220	125	95	4,69	6,56 5,20	4,69	6,56 5,20	4,69	6,56 5,20	-	-	-	-	-	-	-	-	-	-	-	-
SSH10.OX240	125	115	4,69	6,56 5,20	4,69	6,56 5,20	4,69	6,56 5,20	4,69	6,56 5,20	4,69	6,56 5,20	-	-	-	-	-	-	-	-
SSH10.OX280	125	155	4,69	6,56 5,20	4,69	6,56 5,20	4,69	6,56 5,20	4,69	6,56 5,20	4,69	6,56 5,20	4,69	6,56 5,20	4,69	6,56 5,20	-	-	-	-

For dimensions and calculation parameters see p. 52.

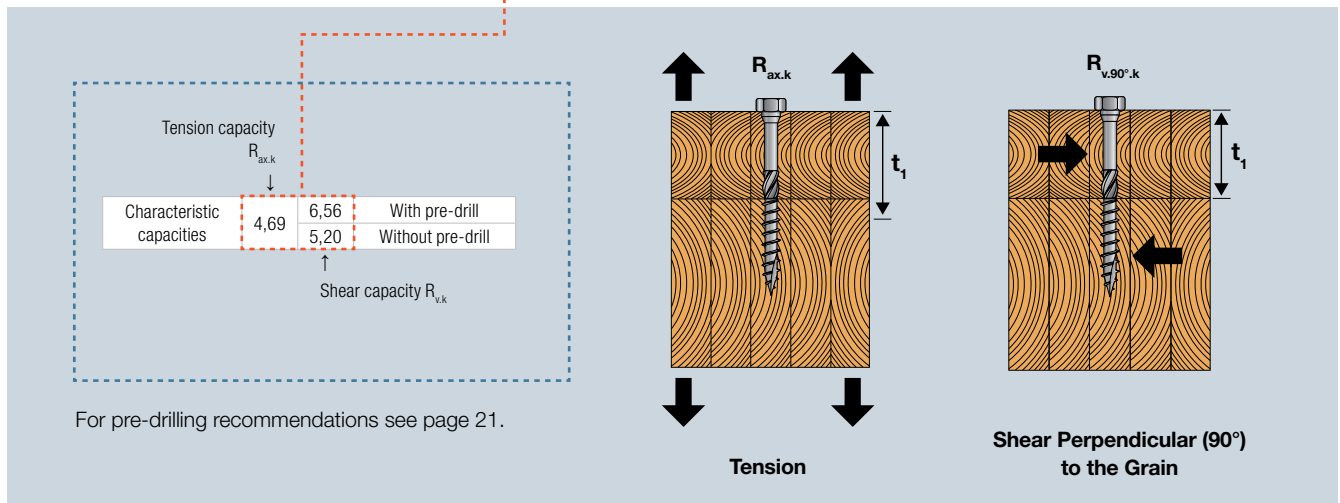

To ensure that the values in this catalog are valid, check that max. 5 mm of the thread is in the first element for partially threaded screws or that max. half the thread +/- 5 mm is in each element for the full-threaded screws.

For additional values in other configurations use Solid Wood - online dimensioning tool. Go to [solidwood.strongtie.eu](http://solidwood.strongtie.eu).

If the screw you are looking for is not shown in this table, it is because the screw cannot fulfil the requirements stated above. In this case, use Solid Wood to determine the capacity of the screw.

### 3.2.1 Glulam Fastening

#### SSH - Minimum distances for Screws in Shear or Combined Loads<sup>1)</sup> Glulam to Glulam GL24h

Outer Thread Diameter d [mm]	Pre-drill	Angle Between Load Direction and Grain = 0°						Angle Between Load Direction and Grain = 90°					
		a <sub>1</sub>	a <sub>2</sub>	a <sub>3,c</sub>	a <sub>3,t</sub>	a <sub>4,c</sub>	a <sub>4,t</sub>	a <sub>1</sub>	a <sub>2</sub>	a <sub>3,c</sub>	a <sub>3,t</sub>	a <sub>4,c</sub>	a <sub>4,t</sub>
6.0	With pre-drill	30	18	42	72	18	18	24	24	42	30	18	42
	Without pre-drill	72	30	60	90	30	30	30	30	60	60	30	60
8.0	With pre-drill	40	24	56	96	24	24	32	32	56	40	24	56
	Without pre-drill	96	40	80	120	40	40	40	40	80	80	40	80
10.0	With pre-drill	50	30	70	120	30	30	40	40	70	50	30	70
	Without pre-drill	120	50	100	150	50	50	50	50	100	100	50	100
12.0	With pre-drill	60	36	84	144	36	36	48	48	84	60	36	84
	Without pre-drill	144	60	120	180	60	60	60	60	120	120	60	120

<sup>1)</sup> Minimum distances comply with EN 1995-1-1 (Eurocode 5) and ETA 21/0670

<sup>2)</sup> Values given in the table are based on the  $\rho_k \leq 385 \text{ kg/m}^3$

<sup>3)</sup> Minimum distances from the unloaded edge perpendicular to the grain may be reduced to  $a_{4,c} = 3 \times d$  if the spacing parallel to the grain ( $a_1$ ) and the end distance ( $a_{3,t}$ ) is at least  $25 \times d$ .

#### SSH - Minimum distances for Axially Loaded Screws Glulam to Glulam GL24h

Outer Thread Diameter d [mm]	a <sub>1</sub>	a <sub>2</sub>	a <sub>3,c</sub>	a <sub>4,c</sub>
6.0	42	30	60	24
8.0	56	40	80	32
10.0	70	50	100	40
12.0	84	60	120	48

\*Valid if the applied centre distances comply with  $a_1 \times a_2 \geq 25d^2$ .

Calculation according to EN1995-1-1:2004+A2:2014

For axially loaded screws installed perpendicular to the surface  $a_{3,t}$  and  $a_{4,t}$  are not relevant. For more info see General Introduction page 24.

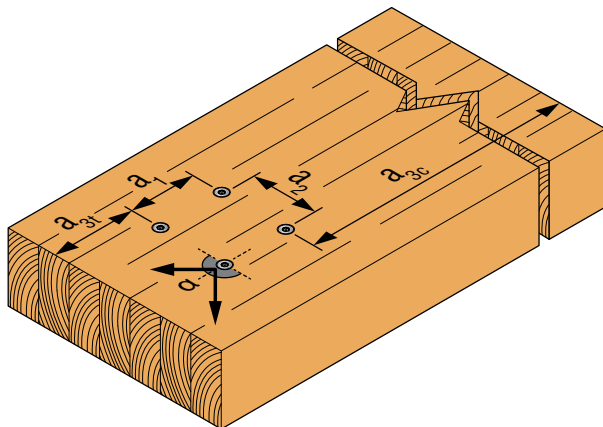

Illustration above shows angle between load direction and grain = 0°

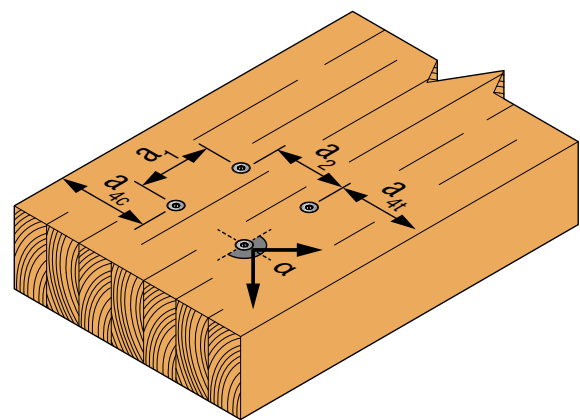

Illustration above shows angle between load direction and grain = 90°

See explanation of  $\alpha$  in General Introduction page 23.





### 3.2.1 Glulam Fastening

ESCRFTC - Characteristic Tension and Shear Capacities, Perpendicular (0°) to the Grain  
 Glulam to Glulam GL24h (continued)

Product Reference	Thread Length $L_g$ [mm]	Max. Advised Wood Thickness $t_1$ [mm]	Tension Capacity $R_{ax,k}$ and Shear Capacity $R_{v,0°k}$ Parallel to the Grain Depending on $t_1$ [kN]															
			Wood Thickness $t_1$ [mm]															
			80	90	100	115	120	140	160	180	200							
ESCRFTC10.0X120	108	108	5,40	6,71	-	-	-	-	-	-	-	-	-	-	-	-	-	-
				4,91	-	-	-	-	-	-	-	-	-	-	-	-	-	-
ESCRFTC10.0X160	148	148	9,17	7,75	9,44	7,75	8,09	7,75	6,07	7,75	5,40	7,38	-	-	-	-	-	-
				6,41	-	6,41	6,41	6,41	5,78	5,59	-	-	-	-	-	-	-	-
ESCRFTC10.0X180	168	168	9,17	8,08	10,52	8,08	10,79	8,08	8,77	8,08	8,09	8,08	7,72	-	-	-	-	-
				6,75	-	6,75	6,75	6,75	6,75	6,75	5,40	5,92	-	-	-	-	-	-
ESCRFTC10.0X200	188	188	9,17	8,42	10,52	8,42	11,87	8,42	11,47	8,42	10,79	8,42	8,09	8,42	5,40	8,06	-	-
				7,09	-	7,09	7,09	7,09	7,09	7,09	7,09	7,09	7,09	6,18	-	-	-	-
ESCRFTC10.0X220	208	208	9,17	8,76	10,52	8,76	11,87	8,76	13,90	8,76	13,49	8,76	10,79	8,76	8,09	8,76	5,40	8,40
				7,43	-	7,43	7,43	7,43	7,43	7,43	7,43	7,43	7,43	6,18	-	-	-	-
ESCRFTC10.0X240	228	228	9,17	9,10	10,52	9,10	11,87	9,10	13,90	9,10	14,57	9,10	13,49	9,10	10,79	9,10	8,09	9,10
				7,76	-	7,76	7,76	7,76	7,76	7,76	7,76	7,76	7,76	7,76	7,76	7,76	7,76	5,40
ESCRFTC10.0X260	248	248	9,17	9,43	10,52	9,43	11,87	9,43	13,90	9,43	14,57	9,43	16,19	9,43	13,49	9,43	10,79	9,43
				7,84	-	7,84	7,84	7,84	7,84	7,84	7,84	7,84	7,84	7,84	7,84	7,84	7,84	7,84
ESCRFTC10.0X280	268	268	9,17	9,77	10,52	9,77	11,87	9,77	13,90	9,77	14,57	9,77	17,27	9,77	16,19	9,77	13,49	9,77
				7,84	-	7,84	7,84	7,84	7,84	7,84	7,84	7,84	7,84	7,84	7,84	7,84	7,84	7,84
ESCRFTC10.0X300	288	288	9,17	10,11	10,52	10,11	11,87	10,11	13,90	10,11	14,57	10,11	17,27	10,11	18,89	10,11	16,19	10,11
				7,84	-	7,84	7,84	7,84	7,84	7,84	7,84	7,84	7,84	7,84	7,84	7,84	7,84	7,84
ESCRFTC10.0X350	338	338	9,17	10,50	10,52	10,50	11,87	10,50	13,90	10,50	14,57	10,50	17,27	10,50	19,97	10,50	22,66	10,50
				7,84	-	7,84	7,84	7,84	7,84	7,84	7,84	7,84	7,84	7,84	7,84	7,84	7,84	7,84
ESCRFTC10.0X400	376	376	7,55	10,50	8,90	10,50	10,25	10,50	12,28	10,50	12,95	10,50	15,65	10,50	18,35	10,50	21,04	10,50
				7,84	-	7,84	7,84	7,84	7,84	7,84	7,84	7,84	7,84	7,84	7,84	7,84	7,84	7,84
ESCRFTC10.0X450	426	426	7,55	10,50	8,90	10,50	10,25	10,50	12,28	10,50	12,95	10,50	15,65	10,50	18,35	10,50	21,04	10,50
				7,84	-	7,84	7,84	7,84	7,84	7,84	7,84	7,84	7,84	7,84	7,84	7,84	7,84	7,84
ESCRFTC12.0X200	180	180	8,70	9,80	10,15	9,80	11,60	9,80	12,33	9,80	11,60	9,80	-	-	-	-	-	-
				8,07	-	8,07	8,07	8,07	8,07	8,07	8,07	8,07	8,07	8,07	8,07	8,07	8,07	8,07
ESCRFTC12.0X220	200	200	8,70	10,17	10,15	10,17	11,60	10,17	13,78	10,17	14,50	10,17	11,60	10,17	-	-	-	-
				8,43	-	8,43	8,43	8,43	8,43	8,43	8,43	8,43	8,43	8,43	8,43	8,43	8,43	8,43
ESCRFTC12.0X240	220	220	8,70	10,53	10,15	10,53	11,60	10,53	13,78	10,53	14,50	10,53	14,50	10,53	11,60	10,53	-	-
				8,79	-	8,79	8,79	8,79	8,79	8,79	8,79	8,79	8,79	8,79	8,79	8,79	8,79	8,79
ESCRFTC12.0X260	240	240	8,70	10,89	10,15	10,89	11,60	10,89	13,78	10,89	14,50	10,89	17,41	10,89	14,50	10,89	11,60	10,89
				9,15	-	9,15	9,15	9,15	9,15	9,15	9,15	9,15	9,15	9,15	9,15	9,15	9,15	9,15
ESCRFTC12.0X280	260	260	8,70	11,25	10,15	11,25	11,60	11,25	13,78	11,25	14,50	11,25	17,41	11,25	17,41	11,25	14,50	11,25
				9,52	-	9,52	9,52	9,52	9,52	9,52	9,52	9,52	9,52	9,52	9,52	9,52	9,52	9,52
ESCRFTC12.0X300	280	280	8,70	11,62	10,15	11,62	11,60	11,62	13,78	11,62	14,50	11,62	17,41	11,62	20,31	11,62	17,41	11,62
				9,60	-	9,60	9,60	9,60	9,60	9,60	9,60	9,60	9,60	9,60	9,60	9,60	9,60	9,60
ESCRFTC12.0X350	330	330	8,70	12,52	10,15	12,52	11,60	12,52	13,78	12,52	14,50	12,52	17,41	12,52	20,31	12,52	23,21	12,52
				9,60	-	9,60	9,60	9,60	9,60	9,60	9,60	9,60	9,60	9,60	9,60	9,60	9,60	9,60
ESCRFTC12.0X400	380	380	8,70	13,08	10,15	13,08	11,60	13,08	13,78	13,08	14,50	13,08	17,41	13,08	20,31	13,08	23,21	13,08
				9,60	-	9,60	9,60	9,60	9,60	9,60	9,60	9,60	9,60	9,60	9,60	9,60	9,60	9,60
ESCRFTC12.0X450	430	430	8,70	13,08	10,15	13,08	11,60	13,08	13,78	13,08	14,50	13,08	17,41	13,08	20,31	13,08	23,21	13,08
				9,60	-	9,60	9,60	9,60	9,60	9,60	9,60	9,60	9,60	9,60	9,60	9,60	9,60	9,60
ESCRFTC12.0X500	480	480	8,70	13,08	10,15	13,08	11,60	13,08	13,78	13,08	14,50	13,08	17,41	13,08	20,31	13,08	23,21	13,08
				9,60	-	9,60	9,60	9,60	9,60	9,60	9,60	9,60	9,60	9,60	9,60	9,60	9,60	9,60
ESCRFTC12.0X600	580	580	8,70	13,08	10,15	13,08	11,60	13,08	13,78	13,08	14,50	13,08	17,41	13,08	20,31	13,08	23,21	13,08
				9,60	-	9,60	9,60	9,60	9,60	9,60	9,60	9,60	9,60	9,60	9,60	9,60	9,60	9,60

For dimensions and calculation parameters see p. 56.

### 3.2.1 Glulam Fastening

#### ESCRFTC - Characteristic Tension and Shear Capacities, Perpendicular (90°) to the Grain Glulam to Glulam GL24h

Product Reference	Thread Length $L_g$ [mm]	Max. Advised Wood Thickness $t_1$ [mm]	Tension Capacity $R_{ax,k}$ and Shear Capacity $R_{v,90°k}$ Perpendicular to the Grain Depending on $t_1$ [kN]																	
			Wood Thickness $t_1$ [mm]																	
			80	90	100	115	120	140	160	180	200	80	90	100	115	120	140	160	180	200
ESCRFTC8.0X120	110	110	4,52	5,09 3,95	3,39	4,66 3,62	-	-	-	-	-	-	-	-	-	-	-	-	-	-
ESCRFTC8.0X140	130	130	6,79	5,37 4,53	5,66	5,37 4,53	4,52	5,37 4,23	-	-	-	-	-	-	-	-	-	-	-	-
ESCRFTC8.0X160	150	150	7,92	5,65 4,82	7,92	5,65 4,82	6,79	5,65 4,82	5,09	5,65 4,70	4,52	5,65 4,52	-	-	-	-	-	-	-	-
ESCRFTC8.0X180	170	170	7,92	5,94 5,10	9,05	5,94 5,10	9,05	5,94 5,10	7,35	5,94 5,10	6,79	5,94 5,10	4,52	5,94 4,79	-	-	-	-	-	-
ESCRFTC8.0X200	190	190	7,92	6,22 5,38	9,05	6,22 5,38	10,18	6,22 5,38	9,61	6,22 5,38	9,05	6,22 5,38	6,79	6,22 5,38	4,52	6,22 4,79	-	-	-	-
ESCRFTC8.0X220	210	210	7,92	6,50 5,39	9,05	6,50 5,39	10,18	6,50 5,39	11,88	6,50 5,39	11,31	6,50 5,39	9,05	6,50 5,39	6,79	6,50 5,39	4,52	6,50 4,79	-	-
ESCRFTC8.0X240	230	230	7,92	6,78 5,39	9,05	6,78 5,39	10,18	6,78 5,39	11,88	6,78 5,39	12,44	6,78 5,39	11,31	6,78 5,39	9,05	6,78 5,39	6,79	6,78 5,39	4,52	6,78 4,79
ESCRFTC8.0X260	250	250	7,92	7,06 5,39	9,05	7,06 5,39	10,18	7,06 5,39	11,88	7,06 5,39	12,44	7,06 5,39	13,57	7,06 5,39	11,31	7,06 5,39	9,05	7,06 5,39	6,79	7,06 5,39
ESCRFTC8.0X280	270	270	7,92	7,06 5,39	9,05	7,06 5,39	10,18	7,06 5,39	11,88	7,06 5,39	12,44	7,06 5,39	14,70	7,06 5,39	13,57	7,06 5,39	11,31	7,06 5,39	9,05	7,06 5,39
ESCRFTC8.0X300	290	290	7,92	7,06 5,39	9,05	7,06 5,39	10,18	7,06 5,39	11,88	7,06 5,39	12,44	7,06 5,39	14,70	7,06 5,39	15,83	7,06 5,39	13,57	7,06 5,39	11,31	7,06 5,39
ESCRFTC8.0X350	340	340	7,92	7,06 5,39	9,05	7,06 5,39	10,18	7,06 5,39	11,88	7,06 5,39	12,44	7,06 5,39	14,70	7,06 5,39	16,97	7,06 5,39	19,23	7,06 5,39	16,97	7,06 5,39
ESCRFTC8.0X400	390	390	7,92	7,06 5,39	9,05	7,06 5,39	10,18	7,06 5,39	11,88	7,06 5,39	12,44	7,06 5,39	14,70	7,06 5,39	16,97	7,06 5,39	19,23	7,06 5,39	21,49	7,06 5,39
ESCRFTC8.0X450	427	427	6,45	7,06 5,39	7,58	7,06 5,39	8,71	7,06 5,39	10,41	7,06 5,39	10,97	7,06 5,39	13,23	7,06 5,39	15,50	7,06 5,39	17,76	7,06 5,39	20,02	7,06 5,39
ESCRFTC10.0X120	108	108	5,40	6,71 4,91	-	-	-	-	-	-	-	-	-	-	-	-	-	-	-	-
ESCRFTC10.0X160	148	148	9,17	7,75 6,41	9,44	7,75 6,41	8,09	7,75 6,41	6,07	7,75 5,78	5,40	7,38 5,59	-	-	-	-	-	-	-	-
ESCRFTC10.0X180	168	168	9,17	8,08 6,75	10,52	8,08 6,75	10,79	8,08 6,75	8,77	8,08 6,75	8,09	8,08 6,75	5,40	7,72 5,92	-	-	-	-	-	-
ESCRFTC10.0X200	188	188	9,17	8,42 7,09	10,52	8,42 7,09	11,87	8,42 7,09	11,47	8,42 7,09	10,79	8,42 7,09	8,09	8,42 7,09	5,40	8,06 6,18	-	-	-	-
ESCRFTC10.0X220	208	208	9,17	8,76 7,43	10,52	8,76 7,43	11,87	8,76 7,43	13,90	8,76 7,43	13,49	8,76 7,43	10,79	8,76 7,43	8,09	8,76 7,43	5,40	8,40 6,18	-	-
ESCRFTC10.0X240	228	228	9,17	9,10 7,76	10,52	9,10 7,76	11,87	9,10 7,76	13,90	9,10 7,76	14,57	9,10 7,76	13,49	9,10 7,76	10,79	9,10 7,76	8,09	9,10 7,76	5,40	8,73 6,18
ESCRFTC10.0X260	248	248	9,17	9,43 7,84	10,52	9,43 7,84	11,87	9,43 7,84	13,90	9,43 7,84	14,57	9,43 7,84	16,19	9,43 7,84	13,49	9,43 7,84	10,79	9,43 7,84	8,09	9,43 7,84
ESCRFTC10.0X280	268	268	9,17	9,77 7,84	10,52	9,77 7,84	11,87	9,77 7,84	13,90	9,77 7,84	14,57	9,77 7,84	17,27	9,77 7,84	16,19	9,77 7,84	13,49	9,77 7,84	10,79	9,77 7,84
ESCRFTC10.0X300	288	288	9,17	10,11 7,84	10,52	10,11 7,84	11,87	10,11 7,84	13,90	10,11 7,84	14,57	10,11 7,84	17,27	10,11 7,84	18,89	10,11 7,84	16,19	10,11 7,84	13,49	10,11 7,84
ESCRFTC10.0X350	338	338	9,17	10,50 7,84	10,52	10,50 7,84	11,87	10,50 7,84	13,90	10,50 7,84	14,57	10,50 7,84	17,27	10,50 7,84	19,97	10,50 7,84	22,66	10,50 7,84	20,24	10,50 7,84
ESCRFTC10.0X400	376	376	7,55	10,50 7,84	8,90	10,50 7,84	10,25	10,50 7,84	12,28	10,50 7,84	12,95	10,50 7,84	15,65	10,50 7,84	18,35	10,50 7,84	21,04	10,50 7,84	23,74	10,50 7,84
ESCRFTC10.0X450	426	426	7,55	10,50 7,84	8,90	10,50 7,84	10,25	10,50 7,84	12,28	10,50 7,84	12,95	10,50 7,84	15,65	10,50 7,84	18,35	10,50 7,84	21,04	10,50 7,84	23,74	10,50 7,84

Table continues on next page.

### 3.2.1 Glulam Fastening

#### ESCRFTC - Characteristic Tension and Shear Capacities, Perpendicular (90°) to the Grain Glulam to Glulam GL24h (continued)

Product Reference	Thread Length $L_y$ [mm]	Max. Advised Wood Thickness $t_1$ [mm]	Tension Capacity $R_{ax,k}$ and Shear Capacity $R_{v,90^\circ,k}$ Perpendicular to the Grain Depending on $t_1$ [kN]																
			Wood Thickness $t_1$ [mm]																
			80	90	100	115	120	140	160	180	200	80	90	100	115	120	140	160	180
ESCRFTC12.0X200	180	180	8,70	9,80 8,07	10,15	9,80 8,07	11,60	9,80 8,07	12,33	9,80 8,07	11,60	9,80 8,07	-	-	-	-	-	-	-
ESCRFTC12.0X220	200	200	8,70	10,17 8,43	10,15	10,17 8,43	11,60	10,17 8,43	13,78	10,17 8,43	14,50	10,17 8,43	11,60	10,17 8,43	-	-	-	-	-
ESCRFTC12.0X240	220	220	8,70	10,53 8,79	10,15	10,53 8,79	11,60	10,53 8,79	13,78	10,53 8,79	14,50	10,53 8,79	14,50	10,53 8,79	11,60	10,53 8,79	-	-	-
ESCRFTC12.0X260	240	240	8,70	10,89 9,15	10,15	10,89 9,15	11,60	10,89 9,15	13,78	10,89 9,15	14,50	10,89 9,15	17,41	10,89 9,15	14,50	10,89 9,15	11,60	10,89 9,15	-
ESCRFTC12.0X280	260	260	8,70	11,25 9,52	10,15	11,25 9,52	11,60	11,25 9,52	13,78	11,25 9,52	14,50	11,25 9,52	17,41	11,25 9,52	17,41	11,25 9,52	14,50	11,25 9,52	11,60
ESCRFTC12.0X300	280	280	8,70	11,62 9,60	10,15	11,62 9,60	11,60	11,62 9,60	13,78	11,62 9,60	14,50	11,62 9,60	17,41	11,62 9,60	20,31	11,62 9,60	17,41	11,62 9,60	14,50
ESCRFTC12.0X350	330	330	8,70	12,52 9,60	10,15	12,52 9,60	11,60	12,52 9,60	13,78	12,52 9,60	14,50	12,52 9,60	17,41	12,52 9,60	20,31	12,52 9,60	23,21	12,52 9,60	21,76
ESCRFTC12.0X400	380	380	8,70	13,08 9,60	10,15	13,08 9,60	11,60	13,08 9,60	13,78	13,08 9,60	14,50	13,08 9,60	17,41	13,08 9,60	20,31	13,08 9,60	23,21	13,08 9,60	26,11
ESCRFTC12.0X450	430	430	8,70	13,08 9,60	10,15	13,08 9,60	11,60	13,08 9,60	13,78	13,08 9,60	14,50	13,08 9,60	17,41	13,08 9,60	20,31	13,08 9,60	23,21	13,08 9,60	26,11
ESCRFTC12.0X500	480	480	8,70	13,08 9,60	10,15	13,08 9,60	11,60	13,08 9,60	13,78	13,08 9,60	14,50	13,08 9,60	17,41	13,08 9,60	20,31	13,08 9,60	23,21	13,08 9,60	26,11
ESCRFTC12.0X600	580	580	8,70	13,08 9,60	10,15	13,08 9,60	11,60	13,08 9,60	13,78	13,08 9,60	14,50	13,08 9,60	17,41	13,08 9,60	20,31	13,08 9,60	23,21	13,08 9,60	26,11

For dimensions and calculation parameters see p. 56.

Glulam

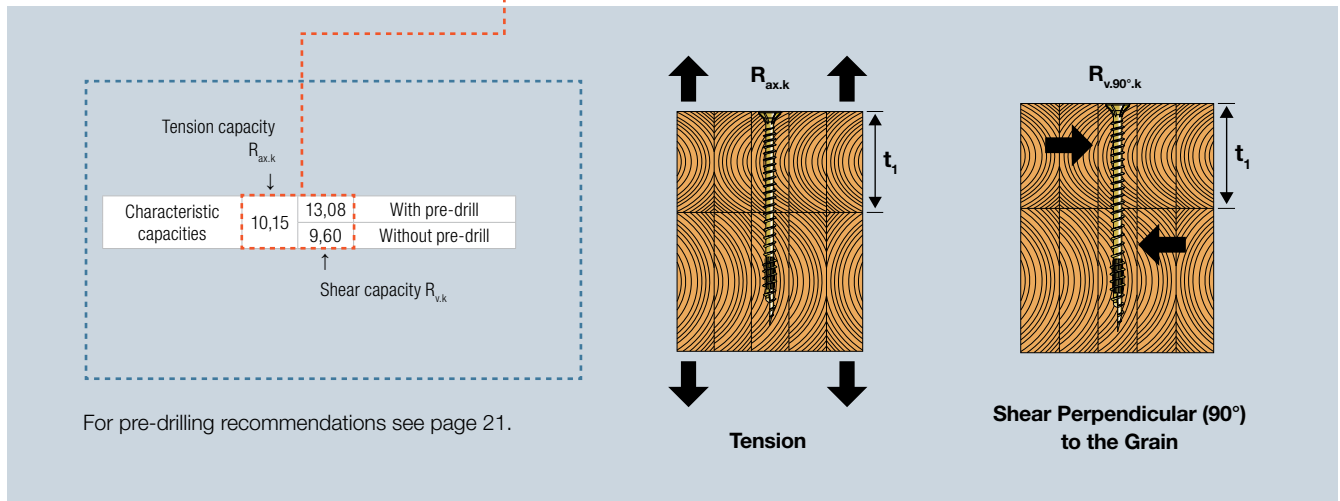

To ensure that the values in this catalog are valid, check that max. 5 mm of the thread is in the first element for partially threaded screws or that max. half the thread +/- 5 mm is in each element for the full-threaded screws.

For additional values in other configurations use Solid Wood - online dimensioning tool. Go to [solidwood.strongtie.eu](http://solidwood.strongtie.eu).

If the screw you are looking for is not shown in this table, it is because the screw cannot fulfil the requirements stated above. In this case, use Solid Wood to determine the capacity of the screw.

### 3.2.1 Glulam Fastening

#### ESCRFTC - Minimum distances for Screws in Shear or Combined Loads<sup>1)</sup> Glulam to Glulam GL24h

Outer Thread Diameter d [mm]	Pre-drill	Angle Between Load Direction and Grain = 0°						Angle Between Load Direction and Grain = 90°					
		a <sub>1</sub>	a <sub>2</sub>	a <sub>3,c</sub>	a <sub>3,t</sub>	a <sub>4,c</sub>	a <sub>4,t</sub>	a <sub>1</sub>	a <sub>2</sub>	a <sub>3,c</sub>	a <sub>3,t</sub>	a <sub>4,c</sub>	a <sub>4,t</sub>
8.0	With pre-drill	40	24	56	96	24	24	32	32	56	40	24	56
	Without pre-drill	96	40	80	120	40	40	40	40	80	80	40	80
10.0	With pre-drill	50	30	70	120	30	30	40	40	70	50	30	70
	Without pre-drill	120	50	100	150	50	50	50	50	100	100	50	100
12.0	With pre-drill	60	36	84	144	36	36	48	48	84	60	36	84
	Without pre-drill	144	60	120	180	60	60	60	60	120	120	60	120

<sup>1)</sup> Minimum distances comply with EN 1995-1-1 (Eurocode 5) and ETA-13/0796

<sup>2)</sup> Values given in the table are based on the  $\rho_k \leq 385 \text{ kg/m}^3$

<sup>3)</sup> Minimum distances from the unloaded edge perpendicular to the grain may be reduced to  $a_{4,c} = 3 \times d$  if the spacing parallel to the grain ( $a_1$ ) and the end distance ( $a_{3,t}$ ) is at least  $25 \times d$ .

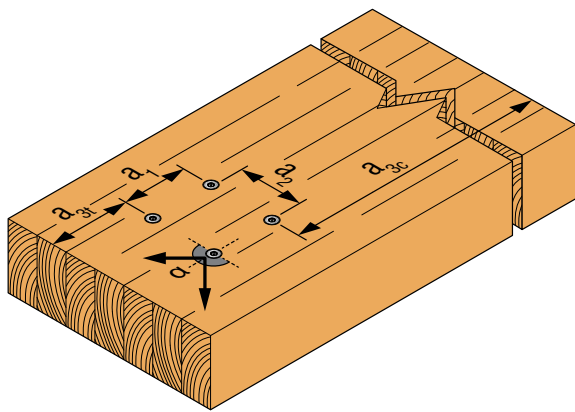

Illustration above shows angle between load direction and grain = 0°

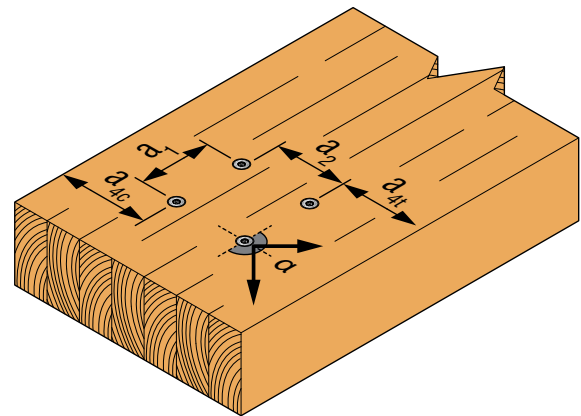

Illustration above shows angle between load direction and grain = 90°

See explanation of  $\alpha$  in General Introduction page 23.

#### ESCRFTC - Minimum distances for Axially Loaded Screw Glulam to Glulam GL24h

Outer Thread Diameter d [mm]	a <sub>1</sub>	a <sub>2</sub>	a <sub>1,cg</sub>	a <sub>2,cg</sub>
8.0	40	20	40	32
10.0	50	25	50	40
12.0	60	30	60	48

\*Valid if the applied centre distances comply with  $a_1 \times a_2 \geq 25d^2$ .  
Calculation according to EN1995-1-1:2004+A2:2014

For axially loaded screws installed perpendicular to the surface  $a_{3,t}$  and  $a_{4,t}$  are not relevant. For more info see General Introduction page 24.

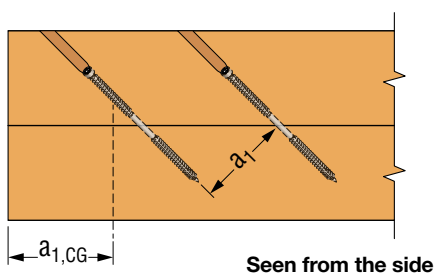

Seen from the side

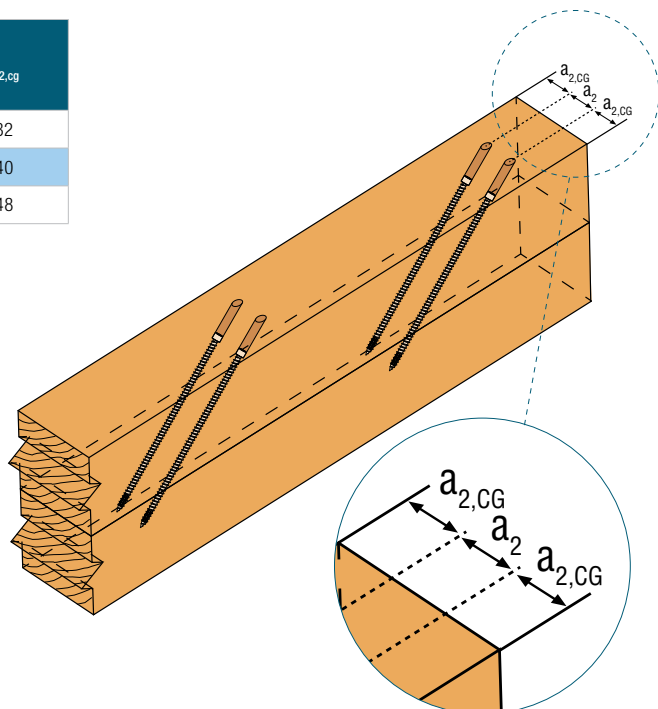

### 3.2.1 Glulam Fastening

## Solid-Drive™ ESCRFTZ Full-Threaded WOOD Screw for Glulam

Yellow Zinc Plated  
C2 acc. to EN ISO 12944-2  
SC2 - 50 years acc. to EC5



ETA-13/0796

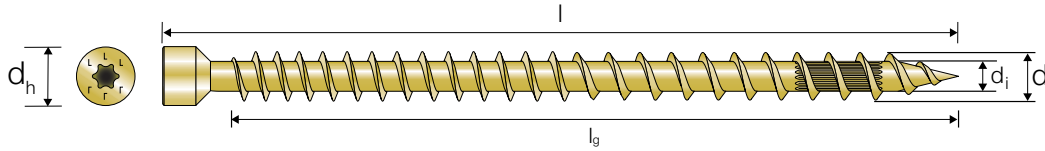

### ESCRFTZ - Characteristic Tension and Shear Capacities, Parallel (0°) to the Grain Glulam to Glulam GL24h

Product Reference	Thread Length $L_s$ [mm]	Max. Advised Wood Thickness $t_1$ [mm]	Tension Capacity $R_{ax,k}$ and Shear Capacity $R_{v,0°k}$ Parallel to the Grain Depending on $t_1$ [kN]															
			Wood Thickness $t_1$ [mm]															
			80		90		100		115		120		140		160		180	
ESCRFTZ8.0X120	110	110	4,52	5,09 3,95	3,39	4,66 3,61	-	-	-	-	-	-	-	-	-	-	-	-
ESCRFTZ8.0X140	130	130	6,79	5,37 4,53	5,66	5,37 4,53	4,52	5,37 4,23	-	-	-	-	-	-	-	-	-	-
ESCRFTZ8.0X160	150	150	7,92	5,65 4,81	7,92	5,65 4,81	6,79	5,65 4,81	5,09	5,65 4,70	4,52	5,65 4,51	-	-	-	-	-	-
ESCRFTZ8.0X180	170	170	7,92	5,93 5,10	9,05	5,93 5,10	9,05	5,93 5,10	7,35	5,93 5,10	6,79	5,93 5,10	4,52	5,93 4,79	-	-	-	-
ESCRFTZ8.0X200	190	190	7,92	6,22 5,38	9,05	6,22 5,38	10,18	6,22 5,38	9,61	6,22 5,38	9,05	6,22 5,38	6,79	6,22 5,38	4,52	6,22 4,79	-	-
ESCRFTZ8.0X220	210	210	7,92	6,50 5,39	9,05	6,50 5,39	10,18	6,50 5,39	11,88	6,50 5,39	11,31	6,50 5,39	9,05	6,50 5,39	6,79	6,50 4,79	4,52	6,50
ESCRFTZ8.0X240	230	230	7,92	6,78 5,39	9,05	6,78 5,39	10,18	6,78 5,39	11,88	6,78 5,39	12,44	6,78 5,39	11,31	6,78 5,39	9,05	6,78 5,39	6,79	6,78 4,52
ESCRFTZ8.0X260	250	250	7,92	7,06 5,39	9,05	7,06 5,39	10,18	7,06 5,39	11,88	7,06 5,39	12,44	7,06 5,39	13,57	7,06 5,39	11,31	7,06 5,39	9,05	7,06 6,79
ESCRFTZ8.0X280	270	270	7,92	7,06 5,39	9,05	7,06 5,39	10,18	7,06 5,39	11,88	7,06 5,39	12,44	7,06 5,39	14,70	7,06 5,39	13,57	7,06 5,39	11,31	7,06 9,05
ESCRFTZ8.0X300	290	290	7,92	7,06 5,39	9,05	7,06 5,39	10,18	7,06 5,39	11,88	7,06 5,39	12,44	7,06 5,39	14,70	7,06 5,39	15,83	7,06 5,39	13,57	7,06 11,31
ESCRFTZ8.0X350	340	340	7,92	7,06 5,39	9,05	7,06 5,39	10,18	7,06 5,39	11,88	7,06 5,39	12,44	7,06 5,39	14,70	7,06 5,39	16,97	7,06 5,39	19,23	7,06 16,97
ESCRFTZ8.0X400	390	390	7,92	7,06 5,39	9,05	7,06 5,39	10,18	7,06 5,39	11,88	7,06 5,39	12,44	7,06 5,39	14,70	7,06 5,39	16,97	7,06 5,39	19,23	7,06 21,49

For dimensions and calculation parameters see p. 58.

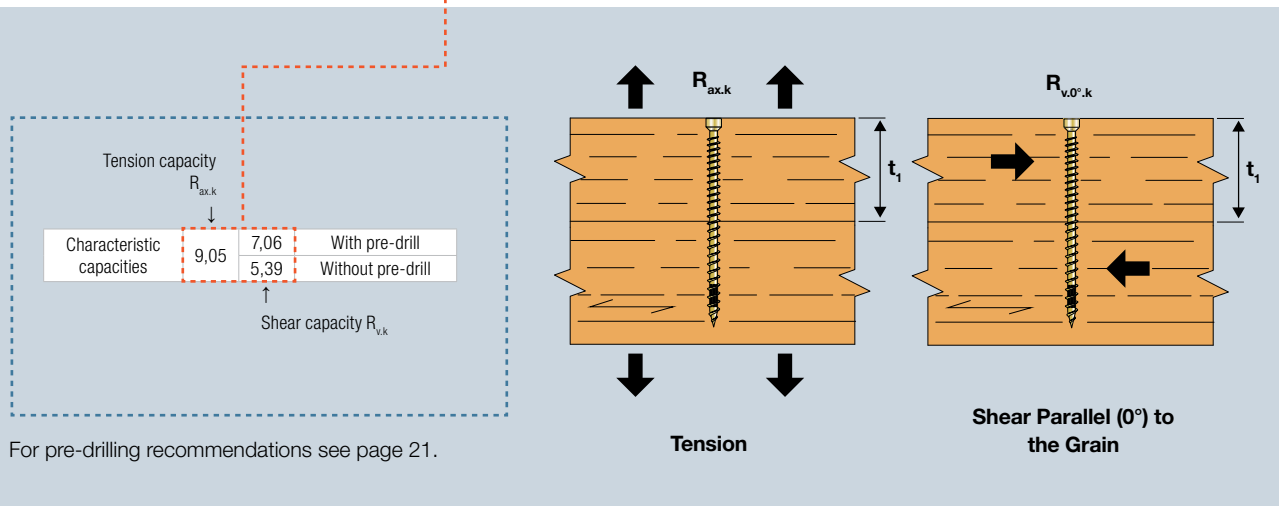



### 3.2.1 Glulam Fastening

#### ESCRFTZ - Characteristic Tension and Shear Capacities, Perpendicular (90°) to the Grain Glulam to Glulam GL24h

Product Reference	Thread Length $L_y$ [mm]	Max. Advised Wood Thickness $t_1$ [mm]	Tension Capacity $R_{ax,k}$ and Shear Capacity $R_{v,90°k}$ Perpendicular to the Grain Depending on $t_1$ [kN]																	
			Wood Thickness $t_1$ [mm]																	
			80	90	100	115	120	140	160	180	200	80	90	100	115	120	140	160	180	200
ESCRFTZ8.0X120	110	110	4,52	5,09 3,95	3,39	4,66 3,61	-	-	-	-	-	-	-	-	-	-	-	-	-	
ESCRFTZ8.0X140	130	130	6,79	5,37 4,53	5,66	5,37 4,81	4,52	5,37 4,23	-	-	-	-	-	-	-	-	-	-	-	
ESCRFTZ8.0X160	150	150	7,92	5,65 4,81	7,92	5,65 4,81	6,79	5,65 4,81	5,09	5,65 4,70	4,52	5,65 4,51	-	-	-	-	-	-	-	
ESCRFTZ8.0X180	170	170	7,92	5,93 5,10	9,05	5,93 5,10	9,05	5,93 5,10	7,35	5,93 5,10	6,79	5,93 5,10	4,52	5,93 4,79	-	-	-	-	-	
ESCRFTZ8.0X200	190	190	7,92	6,22 5,38	9,05	6,22 5,38	10,18	6,22 5,38	9,61	6,22 5,38	9,05	6,22 5,38	6,79	6,22 5,38	4,52	6,22 4,79	-	-	-	
ESCRFTZ8.0X220	210	210	7,92	6,50 5,39	9,05	6,50 5,39	10,18	6,50 5,39	11,88	6,50 5,39	11,31	6,50 5,39	9,05	6,50 5,39	6,79	6,50 5,39	4,52	6,50 4,79	-	
ESCRFTZ8.0X240	230	230	7,92	6,78 5,39	9,05	6,78 5,39	10,18	6,78 5,39	11,88	6,78 5,39	12,44	6,78 5,39	11,31	6,78 5,39	9,05	6,78 5,39	6,79	6,78 5,39	4,52	6,78 4,79
ESCRFTZ8.0X260	250	250	7,92	7,06 5,39	9,05	7,06 5,39	10,18	7,06 5,39	11,88	7,06 5,39	12,44	7,06 5,39	13,57	7,06 5,39	11,31	7,06 5,39	9,05	7,06 5,39	6,79	7,06 5,39
ESCRFTZ8.0X280	270	270	7,92	7,06 5,39	9,05	7,06 5,39	10,18	7,06 5,39	11,88	7,06 5,39	12,44	7,06 5,39	14,70	7,06 5,39	13,57	7,06 5,39	11,31	7,06 5,39	9,05	7,06 5,39
ESCRFTZ8.0X300	290	290	7,92	7,06 5,39	9,05	7,06 5,39	10,18	7,06 5,39	11,88	7,06 5,39	12,44	7,06 5,39	14,70	7,06 5,39	15,83	7,06 5,39	13,57	7,06 5,39	11,31	7,06 5,39
ESCRFTZ8.0X350	340	340	7,92	7,06 5,39	9,05	7,06 5,39	10,18	7,06 5,39	11,88	7,06 5,39	12,44	7,06 5,39	14,70	7,06 5,39	16,97	7,06 5,39	19,23	7,06 5,39	16,97	7,06 5,39
ESCRFTZ8.0X400	390	390	7,92	7,06 5,39	9,05	7,06 5,39	10,18	7,06 5,39	11,88	7,06 5,39	12,44	7,06 5,39	14,70	7,06 5,39	16,97	7,06 5,39	19,23	7,06 5,39	21,49	7,06 5,39

For dimensions and calculation parameters see p. 58.

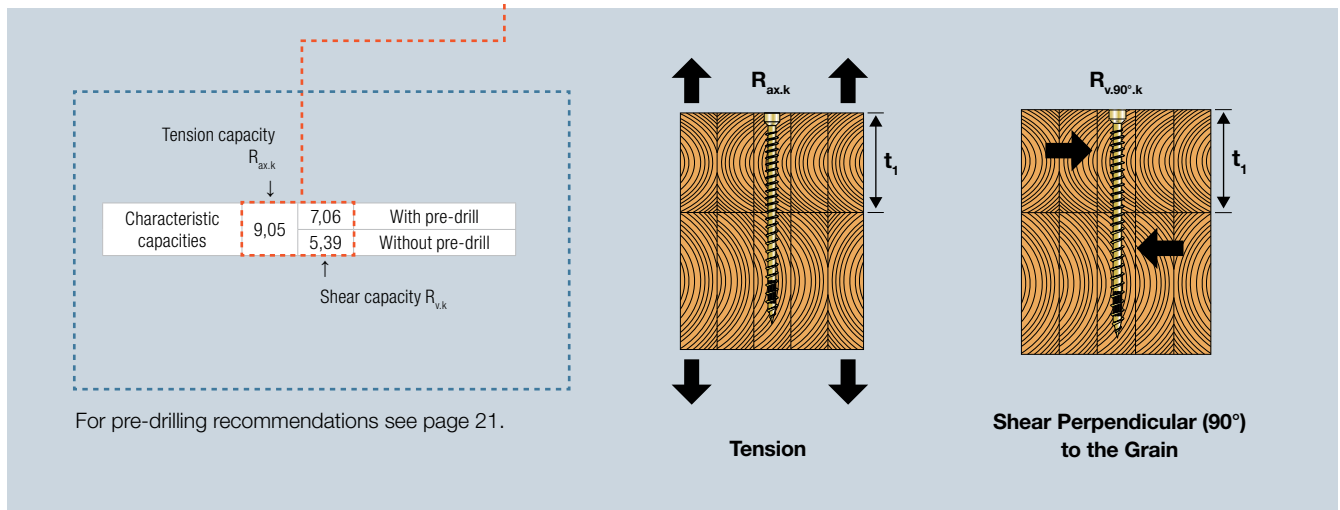

To ensure that the values in this catalog are valid, check that max. 5 mm of the thread is in the first element for partially threaded screws or that max. half the thread +/- 5 mm is in each element for the full-threaded screws.

For additional values in other configurations use Solid Wood - online dimensioning tool. Go to [solidwood.strongtie.eu](http://solidwood.strongtie.eu).

If the screw you are looking for is not shown in this table, it is because the screw cannot fulfil the requirements stated above. In this case, use Solid Wood to determine the capacity of the screw.

### 3.2.1 Glulam Fastening

## Solid-Drive™ ESCRFT Full-Threaded WOOD Screw for Glulam

**Yellow Zinc Plated**  
C2 acc. to EN ISO 12944-2  
SC2 - 50 years acc. to EC5



ETA-13/0796

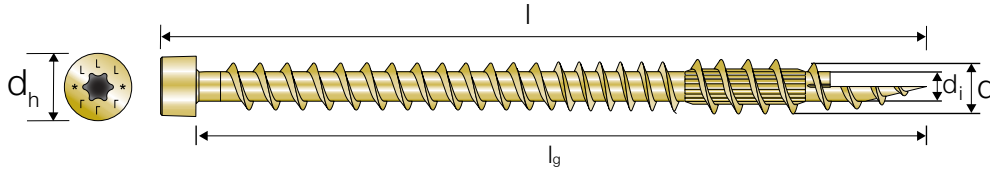

ESCRFT - Characteristic Tension and Shear Capacities, Parallel (0°) to the Grain  
Glulam to Glulam GL24h

Product Reference	Thread Length $L_s$ [mm]	Max. Advised Wood Thickness $t_1$ [mm]	Tension Capacity $R_{ax,k}$ and Shear Capacity $R_{v,0^\circ,k}$ Parallel to the Grain Depending on $t_1$ [kN]																	
			Wood Thickness $t_1$ [mm]																	
			80		90		100		115		120		140		160		180		200	
ESCRFT10.0X450	426	426	7,55	10,50 7,84	8,90	10,50 7,84	10,25	10,50 7,84	12,28	10,50 7,84	12,95	10,50 7,84	15,65	10,50 7,84	18,35	10,50 7,84	21,04	10,50 7,84	23,74	10,50 7,84
ESCRFT10.0X500	476	476	7,55	10,50 7,84	8,90	10,50 7,84	10,25	10,50 7,84	12,28	10,50 7,84	12,95	10,50 7,84	15,65	10,50 7,84	18,35	10,50 7,84	21,04	10,50 7,84	23,74	10,50 7,84
ESCRFT10.0X600	576	576	7,55	10,50 7,84	8,90	10,50 7,84	10,25	10,50 7,84	12,28	10,50 7,84	12,95	10,50 7,84	15,65	10,50 7,84	18,35	10,50 7,84	21,04	10,50 7,84	23,74	10,50 7,84
ESCRFT10.0X800	776	776	7,55	10,50 7,84	8,90	10,50 7,84	10,25	10,50 7,84	12,28	10,50 7,84	12,95	10,50 7,84	15,65	10,50 7,84	18,35	10,50 7,84	21,04	10,50 7,84	23,74	10,50 7,84
ESCRFT10.0X1000	976	976	7,69	10,50 7,84	9,04	10,50 7,84	10,39	10,50 7,84	12,41	10,50 7,84	13,09	10,50 7,84	15,78	10,50 7,84	18,48	10,50 7,84	21,18	10,50 7,84	23,88	10,50 7,84

For dimensions and calculation parameters see p. 60.

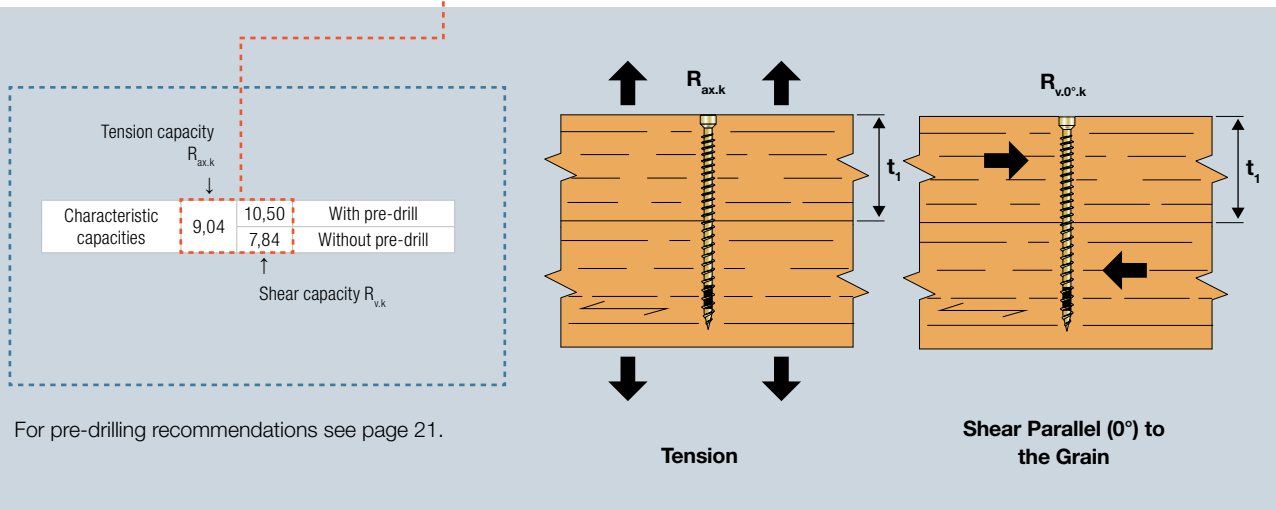

### 3.2.1 Glulam Fastening

#### ESCRFT - Characteristic Tension and Shear Capacities, Perpendicular (90°) to the Grain Glulam to Glulam GL24h

Product Reference	Thread Length $L_y$ [mm]	Max. Advised Wood Thickness $t_1$ [mm]	Tension Capacity $R_{ax,k}$ and Shear Capacity $R_{v,90°k}$ Perpendicular to the Grain Depending on $t_1$ [kN]																	
			Wood Thickness $t_1$ [mm]																	
			80		90		100		115		120		140		160		180		200	
ESCRFT10.0X450	426	426	7,55	10,50 7,84	8,90	10,50 7,84	10,25	10,50 7,84	12,28	10,50 7,84	12,95	10,50 7,84	15,65	10,50 7,84	18,35	10,50 7,84	21,04	10,50 7,84	23,74	10,50 7,84
ESCRFT10.0X500	476	476	7,55	10,50 7,84	8,90	10,50 7,84	10,25	10,50 7,84	12,28	10,50 7,84	12,95	10,50 7,84	15,65	10,50 7,84	18,35	10,50 7,84	21,04	10,50 7,84	23,74	10,50 7,84
ESCRFT10.0X600	576	576	7,55	10,50 7,84	8,90	10,50 7,84	10,25	10,50 7,84	12,28	10,50 7,84	12,95	10,50 7,84	15,65	10,50 7,84	18,35	10,50 7,84	21,04	10,50 7,84	23,74	10,50 7,84
ESCRFT10.0X800	776	776	7,55	10,50 7,84	8,90	10,50 7,84	10,25	10,50 7,84	12,28	10,50 7,84	12,95	10,50 7,84	15,65	10,50 7,84	18,35	10,50 7,84	21,04	10,50 7,84	23,74	10,50 7,84
ESCRFT10.0X1000	976	976	7,69	10,50 7,84	9,04	10,50 7,84	10,39	10,50 7,84	12,41	10,50 7,84	13,09	10,50 7,84	15,78	10,50 7,84	18,48	10,50 7,84	21,18	10,50 7,84	23,88	10,50 7,84

For dimensions and calculation parameters see p. 60.

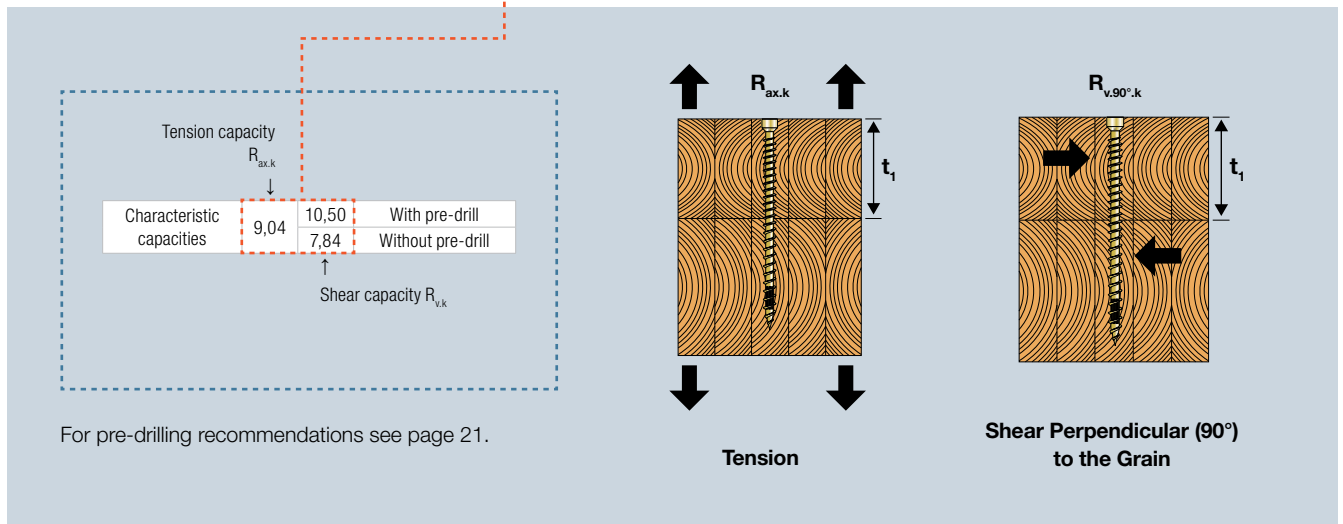

To ensure that the values in this catalog are valid, check that max. 5 mm of the thread is in the first element for partially threaded screws or that max. half the thread +/- 5 mm is in each element for the full-threaded screws.

For additional values in other configurations use Solid Wood - online dimensioning tool. Go to [solidwood.strongtie.eu](http://solidwood.strongtie.eu).

If the screw you are looking for is not shown in this table, it is because the screw cannot fulfil the requirements stated above. In this case, use Solid Wood to determine the capacity of the screw.

### 3.2.1 Glulam Fastening

#### ESCRFTZ/ESCRFT - Minimum distances for Screws in Shear or Combined Loads<sup>1)</sup> Glulam to Glulam GL24h

Outer Thread Diameter d [mm]	Pre-drill	Angle Between Load Direction and Grain = 0°						Angle Between Load Direction and Grain = 90°					
		a <sub>1</sub>	a <sub>2</sub>	a <sub>3,c</sub>	a <sub>3,t</sub>	a <sub>4,c</sub>	a <sub>4,t</sub>	a <sub>1</sub>	a <sub>2</sub>	a <sub>3,c</sub>	a <sub>3,t</sub>	a <sub>4,c</sub>	a <sub>4,t</sub>
8.0	With pre-drill	40	24	56	96	24	24	32	32	56	40	24	56
	Without pre-drill	96	40	80	120	40	40	40	40	80	80	40	80
10.0	With pre-drill	50	30	70	120	30	30	40	40	70	50	30	70
	Without pre-drill	120	50	100	150	50	50	50	50	100	100	50	100

<sup>1)</sup> Minimum distances comply with EN 1995-1-1 (Eurocode 5) and ETA-13/0796

<sup>2)</sup> Values given in the table are based on the  $\rho_k \leq 385 \text{ kg/m}^3$

<sup>3)</sup> Minimum distances from the unloaded edge perpendicular to the grain may be reduced to  $a_{4,c} = 3 \times d$  if the spacing parallel to the grain ( $a_1$ ) and the end distance ( $a_{3,y}$ ) is at least  $25 \times d$ .

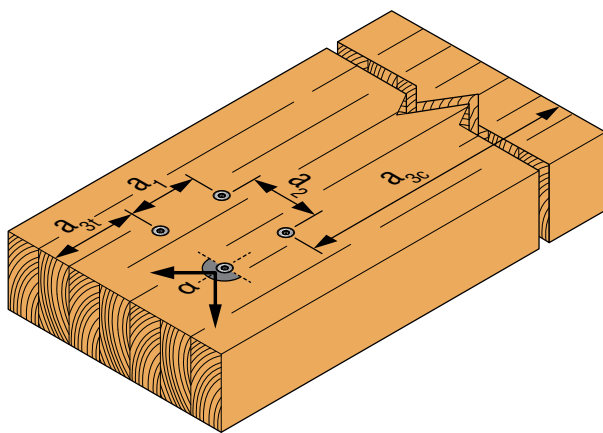

Illustration above shows angle between load direction and grain = 0°

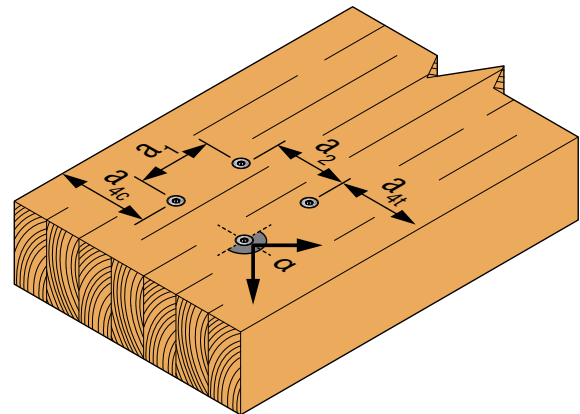

Illustration above shows angle between load direction and grain = 90°

See explanation of  $\alpha$  in General Introduction page 23.

#### ESCRFTZ/ESCRFT - Minimum distances for Axially Loaded Screws Glulam to Glulam GL24h

Outer Thread Diameter d [mm]	a <sub>1</sub>	a <sub>2</sub>	a <sub>1,cg</sub>	a <sub>2,cg</sub>
8.0	40	20	40	32
10.0	50	25	50	40

\*Valid if the applied centre distances comply with  $a_1 \times a_2 \geq 25d^2$ .  
Calculation according to EN1995-1-1:2004+A2:2014

For axially loaded screws installed perpendicular to the surface  $a_{3,t}$  and  $a_{4,t}$  are not relevant. For more info see General Introduction page 24.

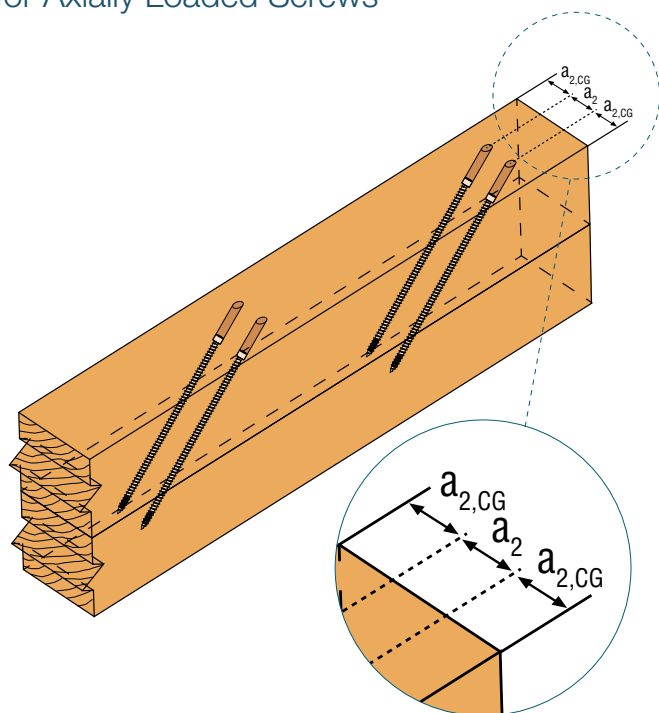
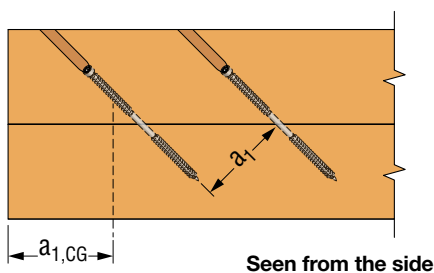

### 3.2.1 Glulam Fastening

## Solid-Drive™ SDW Structural WOOD Screw for Glulam

**Electrocoat**  
C2 acc. to EN ISO 12944-2  
SC2 - 50 years acc. to EC5

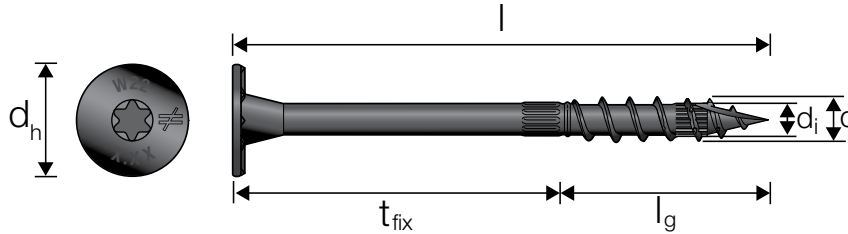

SDW - Characteristic Tension and Shear Capacities, Parallel (0°) to the Grain  
Glulam to Glulam GL24h

Product Reference	Thread Length $L_g$ [mm]	Max. Advised Wood Thickness $t_1$ [mm]	Tension Capacity $R_{ax,k}$ and Shear Capacity $R_{v,0^\circ,k}$ Parallel to the Grain Depending on $t_1$ [kN]																
			Wood Thickness $t_1$ [mm]																
			42	48	56	60	66	80	90	100	115								
SDW22300(8.0x76)	36	40	3,87	3,56 2,73	-	-	-	-	-	-	-	-	-	-	-	-	-	-	
SDW22338(8.0x86)	40	46	4,56	3,94 3,05	4,33	3,86 3,01	-	-	-	-	-	-	-	-	-	-	-	-	
SDW22438(8.0x111)	37	74	4,22	3,85 3,04	4,22	3,85 3,21	4,22	3,85 3,27	4,22	3,85 3,27	4,22	3,85 3,12	-	-	-	-	-	-	
SDW22458(8.0x118)	36	82	4,10	3,82 3,01	4,10	3,82 3,19	4,10	3,82 3,24	4,10	3,82 3,24	4,10	3,82 3,24	4,10	3,75 2,89	-	-	-	-	
SDW22500(8.0x127)	40	87	4,56	3,94 3,12	4,56	3,94 3,30	4,56	3,94 3,36	4,56	3,94 3,36	4,56	3,94 3,36	4,56	3,94 3,27	4,22	3,81 2,98	-	-	
SDW22600(8.0x152)	37	115	4,22	3,85 3,04	4,22	3,85 3,21	4,22	3,85 3,27	4,22	3,85 3,27	4,22	3,85 3,27	4,22	3,85 3,27	4,22	3,85 3,27	4,22	3,85 3,27	4,22
SDW22638(8.0x162)	36	126	4,10	3,82 3,01	4,10	3,82 3,19	4,10	3,82 3,24	4,10	3,82 3,24	4,10	3,82 3,24	4,10	3,82 3,24	4,10	3,82 3,24	4,10	3,82 3,24	4,10
SDW22634(8.0x171)	40	131	4,56	3,94 3,12	4,56	3,94 3,30	4,56	3,94 3,36	4,56	3,94 3,36	4,56	3,94 3,36	4,56	3,94 3,36	4,56	3,94 3,36	4,56	3,94 3,36	4,56

For dimensions and calculation parameters see p. 70.

Tension capacity $R_{ax,k}$		
Characteristic capacities	4,56	3,94
		3,30
Shear capacity $R_{v,k}$		

With pre-drill / Without pre-drill

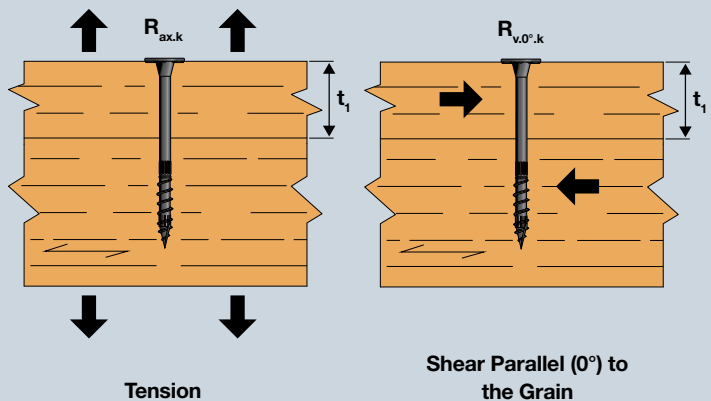

For pre-drilling recommendations see page 21.

### 3.2.1 Glulam Fastening

#### SDW - Characteristic Tension and Shear Capacities, Perpendicular (90°) to the Grain Glulam to Glulam GL24h

Product Reference	Thread Length $L_g$ [mm]	Max. Advised Wood Thickness $t_1$ [mm]	Tension Capacity $R_{ax,k}$ and Shear Capacity $R_{v,90^\circ,k}$ Perpendicular to the Grain Depending on $t_1$ [kN]																	
			Wood Thickness $t_1$ [mm]																	
			42	48	56	60	66	80	90	100	115	42	48	56	60	66	80	90	100	115
SDW22300(8.0x76)	36	40	3,87	3,56 2,73	-	-	-	-	-	-	-	-	-	-	-	-	-	-	-	
SDW22338(8.0x86)	40	46	4,56	3,94 3,05	4,33	3,86 3,01	-	-	-	-	-	-	-	-	-	-	-	-	-	
SDW22438(8.0x111)	37	74	4,22	3,85 3,04	4,22	3,85 3,21	4,22	3,85 3,27	4,22	3,85 3,27	4,22	3,85 3,12	-	-	-	-	-	-	-	
SDW22458(8.0x118)	36	82	4,10	3,82 3,01	4,10	3,82 3,19	4,10	3,82 3,24	4,10	3,82 3,24	4,10	3,82 3,24	4,10	3,75 2,89	-	-	-	-	-	
SDW22500(8.0x127)	40	87	4,56	3,94 3,12	4,56	3,94 3,30	4,56	3,94 3,36	4,56	3,94 3,36	4,56	3,94 3,36	4,56	3,94 3,27	4,22	3,81 2,98	-	-	-	
SDW22600(8.0x152)	37	115	4,22	3,85 3,04	4,22	3,85 3,21	4,22	3,85 3,27	4,22	3,85 3,27	4,22	3,85 3,27	4,22	3,85 3,27	4,22	3,85 3,27	4,22	3,85 3,27	4,22	3,73 2,90
SDW22638(8.0x162)	36	126	4,10	3,82 3,01	4,10	3,82 3,19	4,10	3,82 3,24	4,10	3,82 3,24	4,10	3,82 3,24	4,10	3,82 3,24	4,10	3,82 3,24	4,10	3,82 3,24	4,10	3,82 3,16
SDW22634(8.0x171)	40	131	4,56	3,94 3,12	4,56	3,94 3,30	4,56	3,94 3,36	4,56	3,94 3,36	4,56	3,94 3,36	4,56	3,94 3,36	4,56	3,94 3,36	4,56	3,94 3,36	4,56	3,94 3,36

For dimensions and calculation parameters see p. 70.

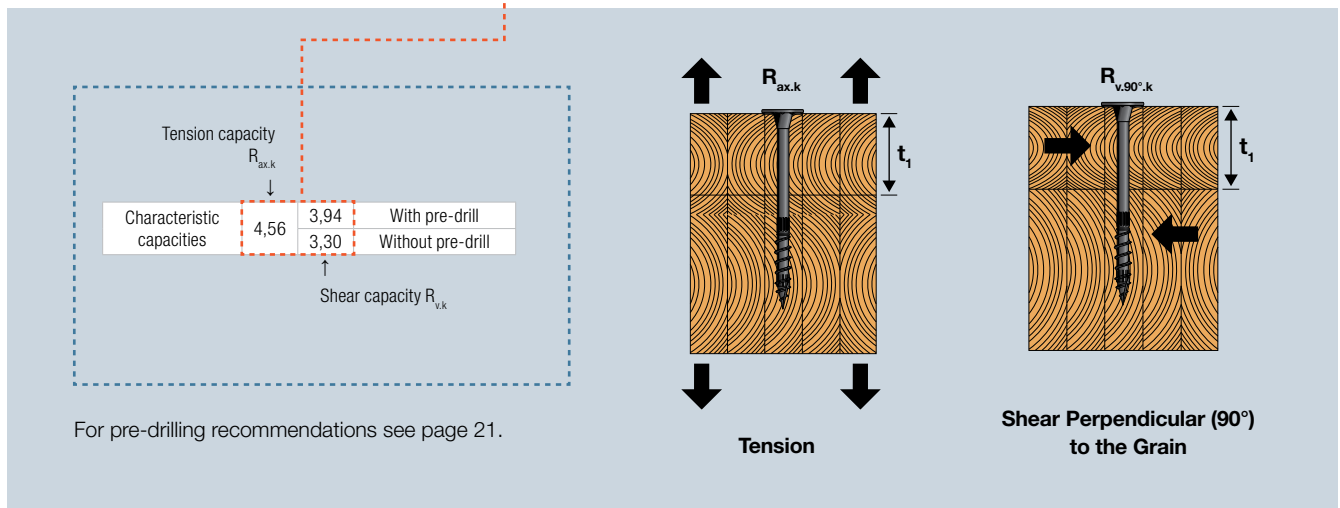

To ensure that the values in this catalog are valid, check that max. 5 mm of the thread is in the first element for partially threaded screws or that max. half the thread +/- 5 mm is in each element for the full-threaded screws.

For additional values in other configurations use Solid Wood - online dimensioning tool. Go to [solidwood.strongtie.eu](http://solidwood.strongtie.eu).

If the screw you are looking for is not shown in this table, it is because the screw cannot fulfil the requirements stated above. In this case, use Solid Wood to determine the capacity of the screw.



### 3.2.1 Glulam Fastening

## Solid-Drive™ SDWS Structural WOOD Screw for Glulam

Double Barrier  
C3 acc. to EN ISO 12944-2  
SC3 - 50 years acc. to EC5

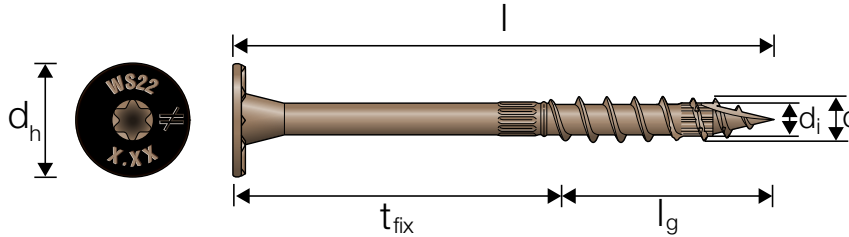

SDWS - Characteristic Tension and Shear Capacities, Parallel (0°) to the Grain  
Glulam to Glulam GL24h

Product Reference	Thread Length $L_g$ [mm]	Max. Advised Wood Thickness $t_1$ [mm]	Tension Capacity $R_{ax,k}$ and Shear Capacity $R_{v,0^\circ,k}$ Parallel to the Grain Depending on $t_1$ [kN]																
			Wood Thickness $t_1$ [mm]																
			42	48	56	60	66	80	90	100	115	42	48	56	60	66	80	90	100
SDWS22300(8.0x76)	36	40	3,87	3,56 2,73	-	-	-	-	-	-	-	-	-	-	-	-	-	-	-
SDWS22400(8.0x101)	58	43	6,61	4,45 3,63	6,04	4,45 3,81	-	-	-	-	-	-	-	-	-	-	-	-	-
SDWS22500(8.0x127)	69	57	7,86	4,77 3,95	7,86	4,77 4,13	7,86	4,77 4,19	7,52	4,77 4,19	-	-	-	-	-	-	-	-	-
SDWS22600(8.0x152)	69	83	7,86	4,77 3,95	7,86	4,77 4,13	7,86	4,77 4,19	7,86	4,77 4,19	7,86	4,77 4,19	7,86	4,77 4,19	-	-	-	-	-
SDWS22800(8.0x204)	69	135	7,86	4,77 3,95	7,86	4,77 4,13	7,86	4,77 4,19	7,86	4,77 4,19	7,86	4,77 4,19	7,86	4,77 4,19	7,86	4,77 4,19	7,86	4,77 4,19	7,86
SDWS221000(8.0x253)	69	184	7,86	4,77 3,95	7,86	4,77 4,13	7,86	4,77 4,19	7,86	4,77 4,19	7,86	4,77 4,19	7,86	4,77 4,19	7,86	4,77 4,19	7,86	4,77 4,19	7,86

For dimensions and calculation parameters see p. 70.

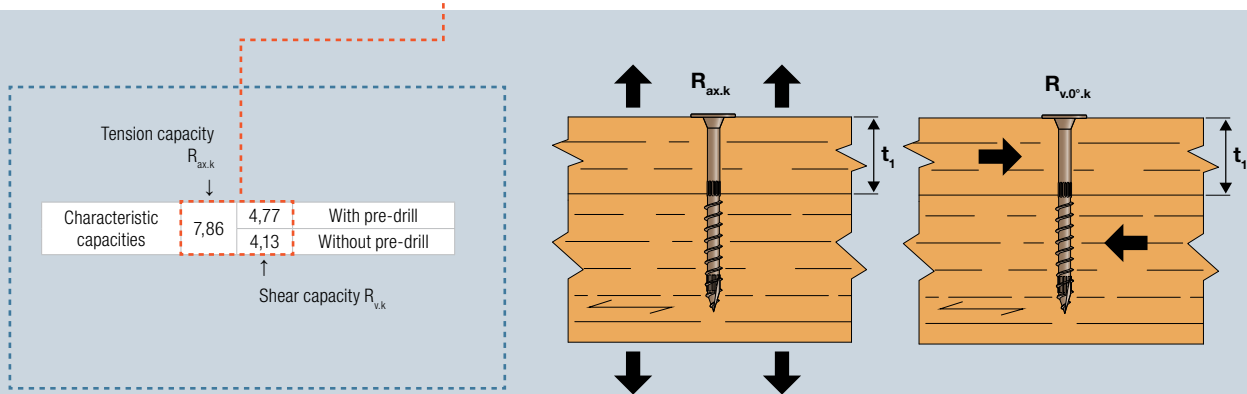

For pre-drilling recommendations see page 21.

C-F-EU-TG-2023-02 (2nd Edition) © 2023 SIMPSON STRONG-TIE COMPANY INC.

Glulam

### 3.2.1 Glulam Fastening

#### SDWS - Characteristic Tension and Shear Capacities, Perpendicular (90°) to the Grain Glulam to Glulam GL24h

Product Reference	Thread Length $L_y$ [mm]	Max. Advised Wood Thickness $t_1$ [mm]	Tension Capacity $R_{ax,k}$ and Shear Capacity $R_{v,90^\circ,k}$ Perpendicular to the Grain Depending on $t_1$ [kN]																	
			Wood Thickness $t_1$ [mm]																	
			42	48	56	60	66	80	90	100	115	42	48	56	60	66	80	90	100	115
SDWS22300 (8.0x76)	3,87	3,56	3,87	3,56	-	-	-	-	-	-	-	-	-	-	-	-	-	-	-	
SDWS22400 (8.0x101)	6,61	4,45	6,61	4,45	6,04	4,45	-	-	-	-	-	-	-	-	-	-	-	-	-	
SDWS22500 (8.0x127)	7,86	4,77	7,86	4,77	7,86	4,77	7,86	4,77	7,52	4,77	-	-	-	-	-	-	-	-	-	
SDWS22600 (8.0x152)	7,86	4,77	7,86	4,77	7,86	4,77	7,86	4,77	7,86	4,77	7,86	4,77	7,86	4,77	-	-	-	-	-	
SDWS22800 (8.0x204)	7,86	4,77	7,86	4,77	7,86	4,77	7,86	4,77	7,86	4,77	7,86	4,77	7,86	4,77	7,86	4,77	7,86	4,77	7,86	
SDWS221000 (8.0x253)	7,86	4,77	7,86	4,77	7,86	4,77	7,86	4,77	7,86	4,77	7,86	4,77	7,86	4,77	7,86	4,77	7,86	4,77	7,86	

For dimensions and calculation parameters see p. 70.

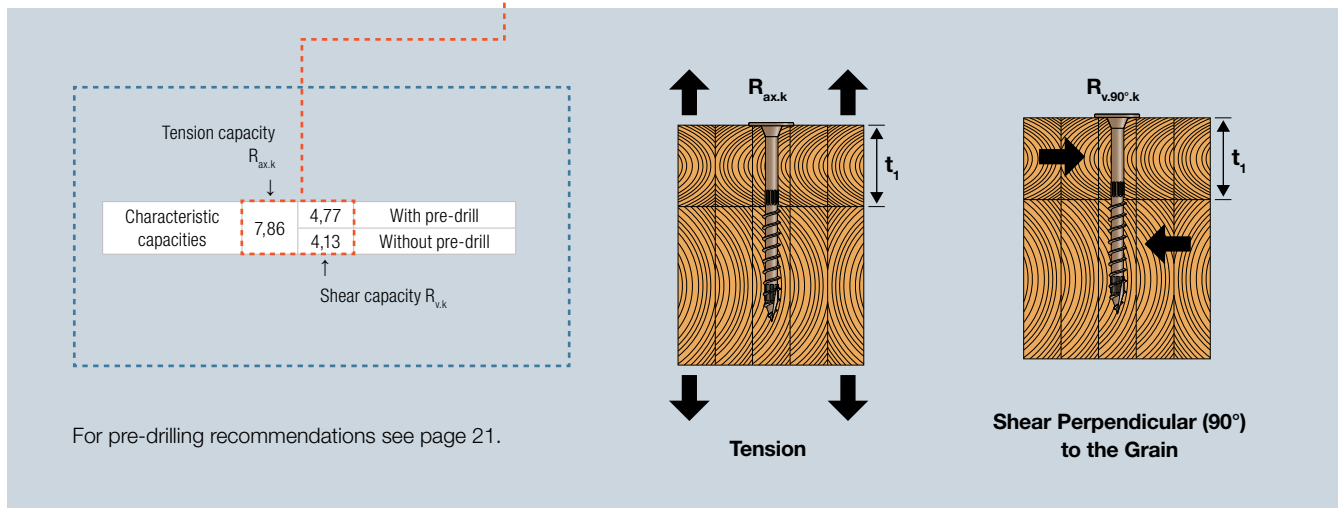

To ensure that the values in this catalog are valid, check that max. 5 mm of the thread is in the first element for partially threaded screws or that max. half the thread +/- 5 mm is in each element for the full-threaded screws.

For additional values in other configurations use Solid Wood - online dimensioning tool. Go to [solidwood.strongtie.eu](http://solidwood.strongtie.eu).

If the screw you are looking for is not shown in this table, it is because the screw cannot fulfil the requirements stated above. In this case, use Solid Wood to determine the capacity of the screw.

### 3.2.1 Glulam Fastening

#### SDW/SDWS - Minimum distances for Screws in Shear or Combined Loads<sup>1)</sup> Glulam to Glulam GL24h

Outer Thread Diameter d [mm]	Pre-drill	Angle Between Load Direction and Grain = 0°						Angle Between Load Direction and Grain = 90°					
		a <sub>1</sub>	a <sub>2</sub>	a <sub>3,c</sub>	a <sub>3,t</sub>	a <sub>4,c</sub>	a <sub>4,t</sub>	a <sub>1</sub>	a <sub>2</sub>	a <sub>3,c</sub>	a <sub>3,t</sub>	a <sub>4,c</sub>	a <sub>4,t</sub>
8.0	With pre-drill	39	24	54	93	24	24	31	31	54	39	24	54
	Without pre-drill	93	39	77	116	39	39	39	39	77	77	39	77

<sup>1)</sup> Minimum distances comply with EN 1995-1-1 (Eurocode 5)

<sup>2)</sup> Values given in the table are based on the  $\rho_k \leq 385 \text{ kg/m}^3$

<sup>3)</sup> Minimum distances from the unloaded edge perpendicular to the grain may be reduced to  $a_{4,c} = 3 \times d$  if the spacing parallel to the grain ( $a_1$ ) and the end distance ( $a_{3,t}$ ) is at least  $25 \times d$ .

#### SDW/SDWS - Minimum distances for Axially Loaded Screws Glulam to Glulam GL24h

Outer Thread Diameter d [mm]	a <sub>1</sub>	a <sub>2</sub>	a <sub>3,c</sub>	a <sub>4,c</sub>
8.0	54	39	77	31

\*Valid if the applied centre distances comply with  $a_1, a_2 \geq 25d^2$ .  
Calculation according to EN1995-1-1:2004+A2:2014

For axially loaded screws installed perpendicular to the surface  $a_{3,t}$  and  $a_{4,t}$  are not relevant. For more info see General Introduction page 24.

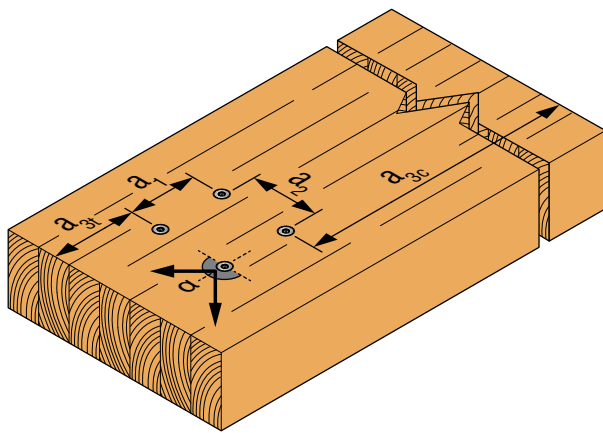

Illustration above shows angle between load direction and grain = 0°

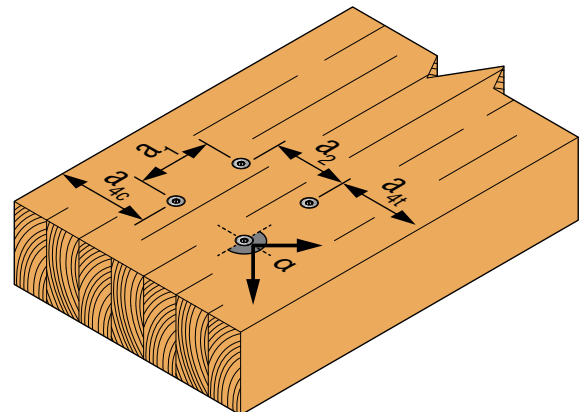

Illustration above shows angle between load direction and grain = 90°

See explanation of  $\alpha$  in General Introduction page 23.



#### Solid Wood Fastener Dimensioning Software

In just four simple steps, Solid Wood guides you through the calculation and selection of fastening solutions suitable for the specific wood structure at hand, all according to Eurocode 5 and our ETA.

Try Solid Wood today. Go to [solidwood.strongtie.eu](http://solidwood.strongtie.eu)

### 3.2.2 Glulam Inclined Installations

## Solid-Drive™ SWD Double-Threaded WOOD Screw for Inclined Installations

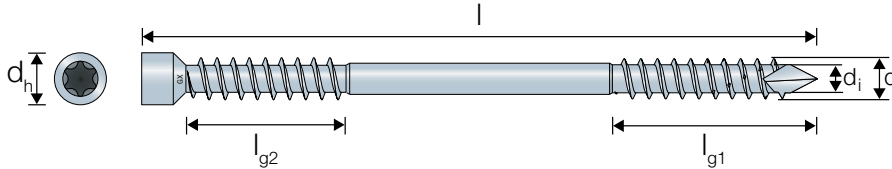

#### SWD - Inclined Installations Glulam to Glulam GL24h

Product Reference	Header			Characteristic Capacity - GL24h		
	Min. Width [mm]			Vertical Load F <sub>v,Rk</sub>		
	30°	45°	60°	30°	45°	60°
SWD6.5X90	23	32	39	2,1	2,3	1,6
SWD6.5X130	33	46	57	2,1	2,3	1,6
SWD6.5X160	40	57	70	3,7	4,0	2,8
SWD6.5X190	48	68	83	4,7	5,0	3,5
SWD6.5X220	55	78	96	5,6	6,0	4,3
SWD8.0X90	23	32	39	2,4	2,5	1,8
SWD8.0X130	33	46	57	2,4	2,5	1,8
SWD8.0X160	40	57	70	4,2	4,5	3,2
SWD8.0X190	48	68	83	5,4	5,7	4,0
SWD8.0X220	55	78	96	6,5	6,9	4,9
SWD8.0X245	62	87	107	7,4	7,9	5,6
SWD8.0X275	69	98	120	7,4	7,9	5,6
SWD8.0X300	75	107	130	9,5	10,1	7,2
SWD8.0X330	83	117	143	9,5	10,1	7,2

Values in the table are valid for predrilled and non predrilled installation.

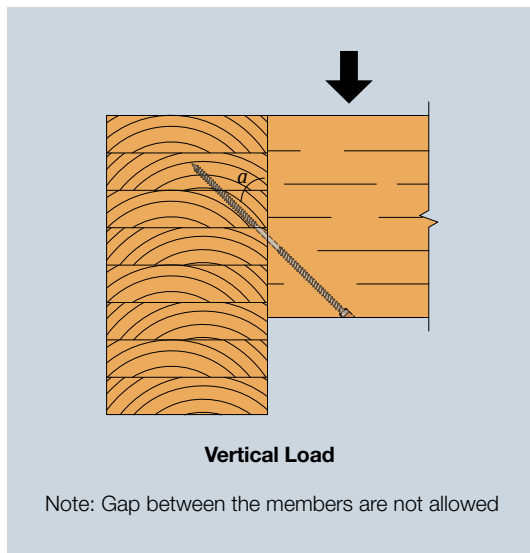

### 3.2.2 Glulam Inclined Installations

## Solid-Drive™ ESCRFTZ Full-Threaded WOOD Screw for Inclined Installations

Yellow Zinc Plated  
C2 acc. to EN ISO 12944-2  
SC2 - 50 years acc. to EC5

UK  
CA



ETA-13/0796

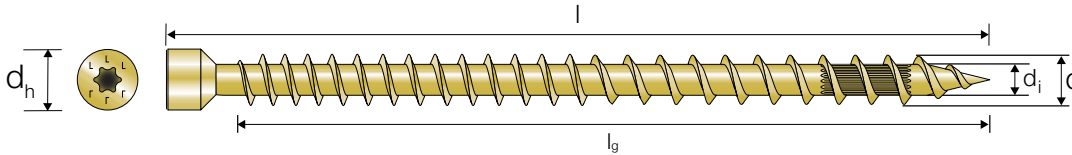

#### ESCRFTZ - Inclined Installations Glulam to Glulam GL24h

Product Reference	Header			Characteristic Capacity - GL24h		
	Min. width [mm]			Vertical Load F <sub>v,Rk</sub>		
	30°	45°	60°	30°	45°	60°
ESCRFTZ8.0X120	30	43	52	4,1	4,4	3,1
ESCRFTZ8.0X140	35	50	61	4,9	5,2	3,7
ESCRFTZ8.0X160	40	57	70	5,6	6,0	4,2
ESCRFTZ8.0X180	45	64	78	6,4	6,8	4,8
ESCRFTZ8.0X200	50	71	87	7,1	7,6	5,4
ESCRFTZ8.0X220	55	78	96	7,9	8,4	5,9
ESCRFTZ8.0X240	60	85	104	8,6	9,2	6,5
ESCRFTZ8.0X260	65	92	113	9,4	10,0	7,1
ESCRFTZ8.0X280	70	99	122	10,1	10,8	7,6
ESCRFTZ8.0X300	75	107	130	10,9	11,6	8,2
ESCRFTZ8.0X350	88	124	152	12,8	13,6	9,6
ESCRFTZ8.0X400	100	142	174	14,6	15,6	11,0

Values in the table are valid for predrilled and non predrilled installation.

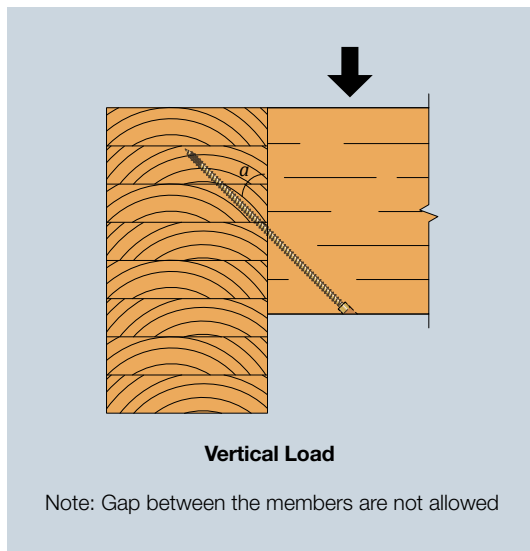

Note: Gap between the members are not allowed

### 3.2.2 Glulam Inclined Installations

## Solid-Drive™ ESCRFT Full-Threaded WOOD Screw for Inclined Installations

Yellow Zinc Plated  
C2 acc. to EN ISO 12944-2  
SC2 - 50 years acc. to EC5

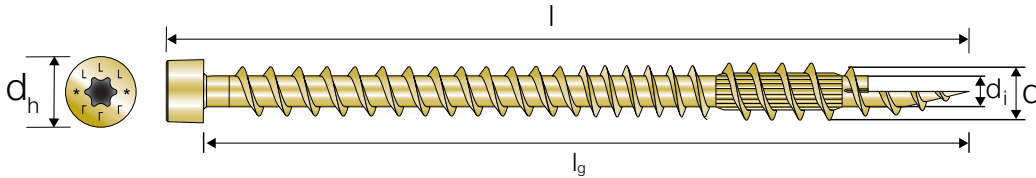

#### ESCRFT - Inclined Installations Glulam to Glulam GL24h

Product Reference	Header			Characteristic Capacity - GL24h		
	Min. width [mm]			Vertical Load $F_{v,Rk}$		
	30°	45°	60°	30°	45°	60°
ESCRFT8.0x450	113	160	195	15,4	16,1	11,4
ESCRFT8.0x500	125	177	217	17,3	17,0	12,1
ESCRFT8.0x600	150	213	260	20,9	17,0	12,1
ESCRFT10.0x450	113	160	195	18,6	19,4	13,7
ESCRFT10.0x500	125	177	217	20,8	21,8	15,4
ESCRFT10.0x600	150	213	260	25,3	26,6	18,8
ESCRFT10.0x800	200	283	347	34,3	28,3	20,0
ESCRFT10.0x1000	250	354	433	34,6	28,3	20,0

Values in the table are valid for predrilled and non predrilled installation.

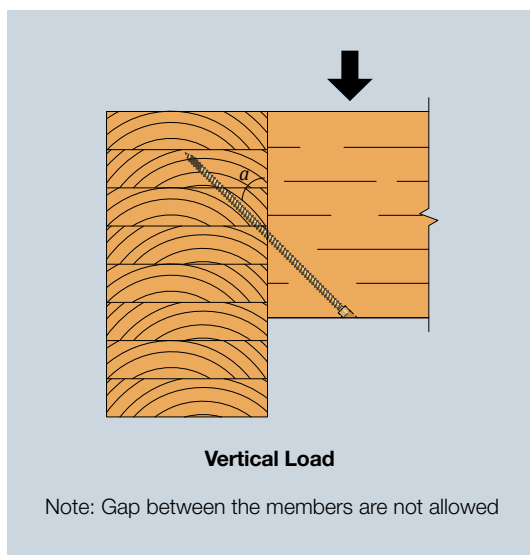



## 3.2.2 Glulam Inclined Installations

### Minimum distances for Inclined Screws

#### SWD

Product Reference	$a_1$	$a_2$	$a_{1,CG}$	$a_{2,CG}$
6.5xℓ	65	20	52	20
8.0xℓ	80	24	64	24

#### ESCRFTZ

Product Reference	$a_1$	$a_2$	$a_{1,CG}$	$a_{2,CG}$
8.0xℓ	40	20	40	32

#### ESCRFT

Product Reference	$a_1$	$a_2$	$a_{1,CG}$	$a_{2,CG}$
8.0xℓ	40	20	40	32
10.0xℓ	50	25	50	40

$a_1$  is taken in the header when the screws are distributed along the grain  
 $a_2$  in the joist where the screw are distributed perpendicularly to the grain.

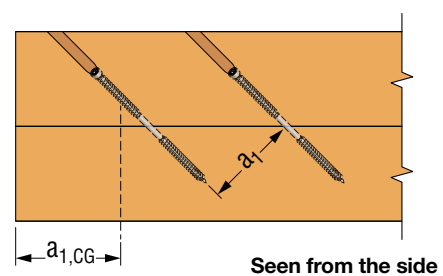
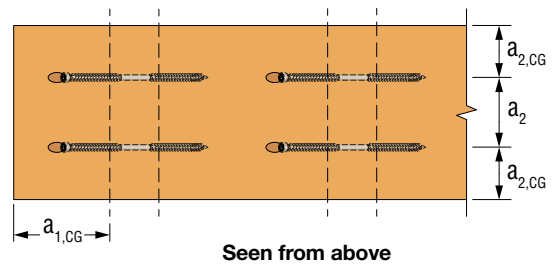
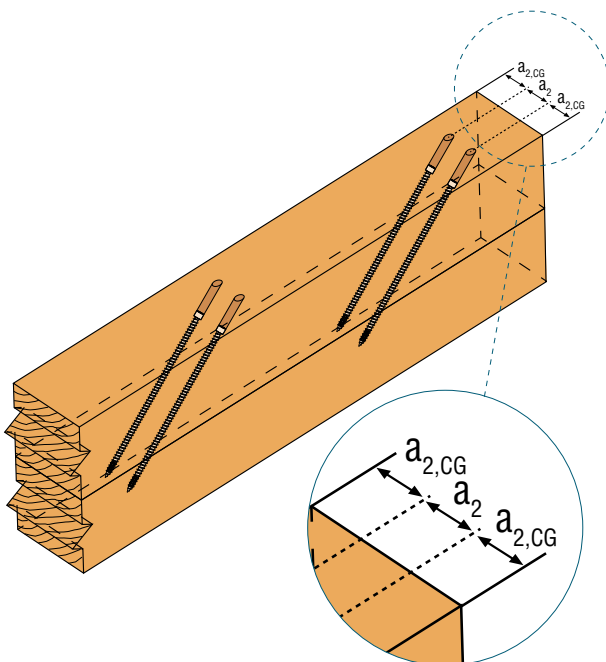
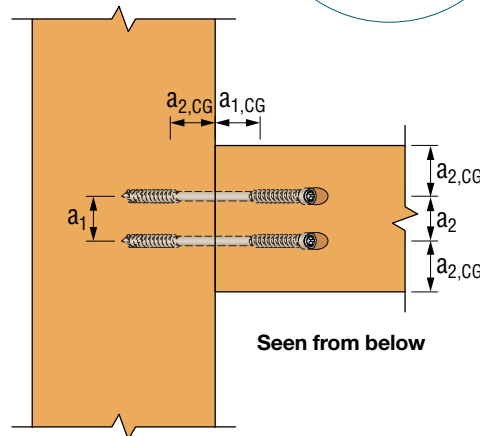
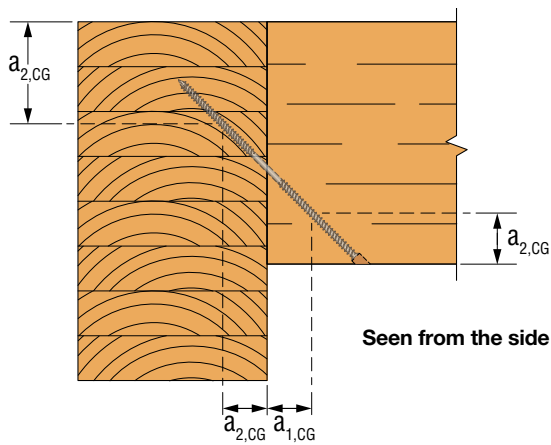
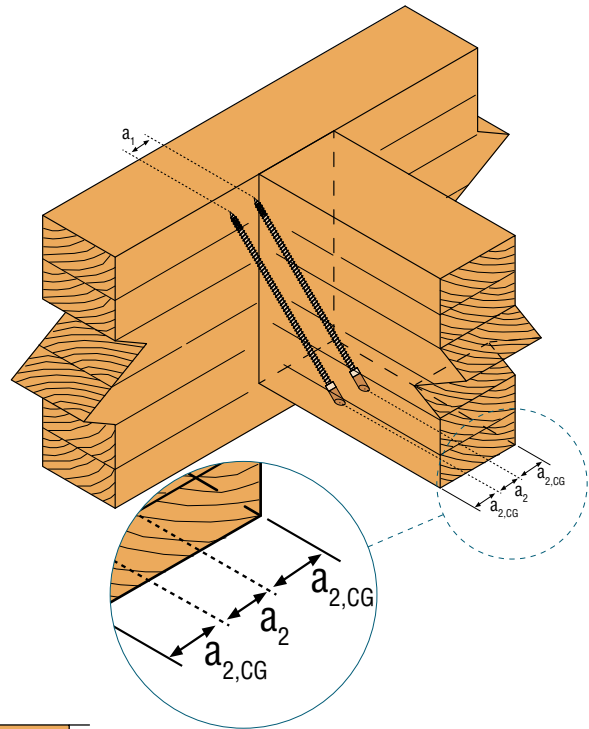

## 3.2.3 Glulam Cross Pairs

### Calculation Example - Glulam Cross Pairs

#### Timber Properties

Timber strength class GL24h Characteristic density:  $\rho_k = 385 \text{ kg/m}^3$

Header Height:  $h_h = 300 \text{ mm}$  Width:  $B_h = 100 \text{ mm}$

Joist Height:  $h_j = 250 \text{ mm}$  Width:  $B_j = 100 \text{ mm}$

#### Loads

Vertical load on support (acc. To EN1991-1-1)  $F_{Ed} = 5,00 \text{ kN}$   $k_{mod} = 0,8$   $\gamma_m = 1,3$   $\gamma_{m1} = 1,1$

#### Screw Choice & Properties

SWD8.0x160  $n = 1 \text{ Pair}$   $L = 160 \text{ mm}$   $l_{ef} = 56,5 \text{ mm}$

The pair is center in the middle of the joist height and the screws are inserted with an angle

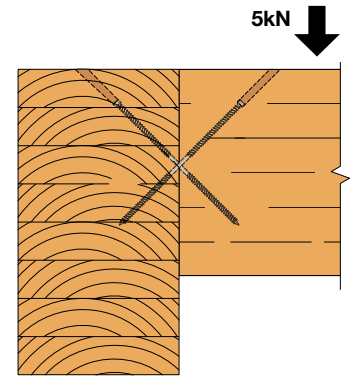

#### Axial Resistance of the Screw

Characteristic axial capacity of the screw according to ETA

$$F_{ax,90,k} = f_{ax,calc,k} \times d \times l_{ef} = 14,1 \times 8 \text{ mm} \times 56,5 \text{ mm} = 6,39 \text{ kN}$$

with:  $l_{ef}$  thread length

$d$  screw thread diameter

$f_{ax,calc,k}$  characteristic withdrawal parameter in GL24h

$$f_{ax,calc,k} = f_{ox,k} \times (\rho_k/350)^{0,8} = 13,1 \times (385/350)^{0,8} = 14,1 \text{ N/mm}^2$$

Characteristic capacity when the load is at  $45^\circ$

$$F_{ax,45,k} = F_{ax,90,k} \times \cos \alpha = 4,51 \text{ kN}$$

Characteristic axial resistance of the pair of screw

$$F_{v,pair,k} = F_{ax,45,k} \times 2^{0,9} = 8,43 \text{ kN}$$

#### Compression Resistance of the Screw

Characteristic compression capacity of the screw according to ETA

$$F_{Rki,45,k} = \kappa_c \times N_{pl,k} \times \frac{\gamma_m}{\gamma_{m1}} \times \cos \alpha = 11,4 \text{ kN}$$

with:  $\kappa_c$  see definition in the ETA  $\kappa_c = 0,6$

$N_{pl,k}$  characteristic value of the plastic normal force load bearing capacity of the net cross section

$$N_{pl,k} = \frac{\pi \times d_i^2}{4} \times f_{y,k} = 22,9 \text{ kN}$$

$$F_{buck,pair,k} = \frac{F_{ax,45,k}}{2} \times 2^{0,9} + \frac{F_{Rki,45,k}}{2} \times \frac{2^{0,9}}{\kappa_{mod}} = 4,21 + 10,46/\kappa_{mod}$$

#### Design Capacity of the Connection

The design connection capacity is equal to:

$$F_{v,d} = \min \left( F_{v,pair,k} \times \frac{\kappa_{mod}}{\gamma_m}; F_{buck,pair,k} \times \frac{\kappa_{mod}}{\gamma_m} \right) = 5,18 \text{ kN}$$

$$F_{v,d} = 5,18 \text{ kN} > 5 \text{ kN} \quad \text{Connection is Ok}$$

#### Notes:

The screws must be placed so each thread is in one timber element.

The distance to the insertion point is:  $m_i = h_j/2 \times \tan \alpha = 250/2 \times \tan 45 = 125 \text{ mm}$

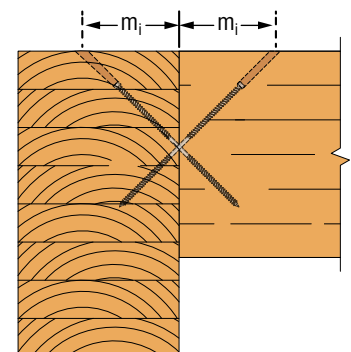

### 3.2.3 Glulam Cross Pairs

## Solid-Drive™ SWD Double-Threaded WOOD Screw for Cross Pairs

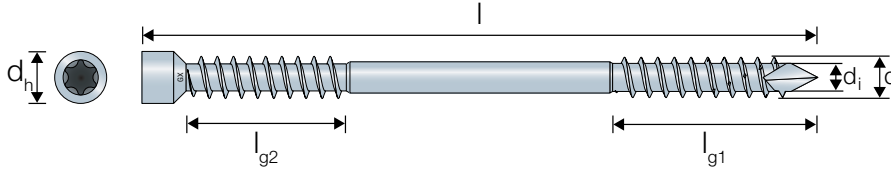
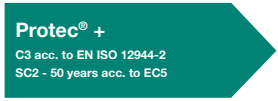

### SWD - 45° Cross Pairs Glulam to Glulam GL24h

Product Reference	Header		Joist		Characteristic Vertical Capacity (Downward or Uplift) - GL24h			
	Min. height [mm]	Min. height [mm]	Min. width [mm]		$R_{v,k, pair} [kN] = \text{Min.}(R_{ax,k} ; R_{buck,k})$			
			1 pair	2 pairs	1 pair		2 pairs	
					$R_{ax,k}$	$R_{buck,k}$	$R_{ax,k}$	$R_{buck,k}$
SWD6.5X90	52	104	68,25	100,75	4,25	$2.12 + 5.65 / k_{mod}$	7,93	$4.24 + 11.3 / k_{mod}$
SWD6.5X130	56	104	68,25	100,75	4,25	$2.12 + 5.65 / k_{mod}$	7,93	$4.24 + 11.3 / k_{mod}$
SWD6.5X160	67	126	68,25	100,75	7,42	$3.7 + 5.65 / k_{mod}$	13,84	$7.41 + 11.3 / k_{mod}$
SWD6.5X190	78	147	68,25	100,75	9,32	$4.66 + 5.65 / k_{mod}$	17,39	$9.32 + 11.3 / k_{mod}$
SWD6.5X220	88	168	68,25	100,75	11,22	$5.61 + 5.65 / k_{mod}$	20,94	$11.22 + 11.3 / k_{mod}$
SWD8.0X90	64	128	84,00	124,00	4,70	$2.35 + 10.46 / k_{mod}$	8,77	$4.7 + 20.92 / k_{mod}$
SWD8.0X130	64	128	84,00	124,00	4,70	$2.35 + 10.46 / k_{mod}$	8,77	$4.7 + 20.92 / k_{mod}$
SWD8.0X160	67	128	84,00	124,00	8,43	$4.21 + 10.46 / k_{mod}$	15,73	$8.43 + 20.92 / k_{mod}$
SWD8.0X190	78	147	84,00	124,00	10,67	$5.33 + 10.46 / k_{mod}$	19,91	$10.67 + 20.92 / k_{mod}$
SWD8.0X220	88	168	84,00	124,00	12,91	$6.45 + 10.46 / k_{mod}$	24,09	$12.9 + 20.92 / k_{mod}$
SWD8.0X245	97	186	84,00	124,00	14,77	$7.38 + 10.46 / k_{mod}$	27,57	$14.77 + 20.92 / k_{mod}$
SWD8.0X275	108	207	84,00	124,00	14,77	$7.38 + 10.46 / k_{mod}$	27,57	$14.77 + 20.92 / k_{mod}$
SWD8.0X300	117	225	84,00	124,00	18,88	$9.43 + 10.46 / k_{mod}$	35,23	$18.87 + 20.92 / k_{mod}$
SWD8.0X330	127	246	84,00	124,00	18,88	$9.43 + 10.46 / k_{mod}$	35,23	$18.87 + 20.92 / k_{mod}$

Min. between  $R_{w,k, pair}$  and  $R_{buck,k, pair}$

Values in the table are valid for predrilled and non predrilled installation.

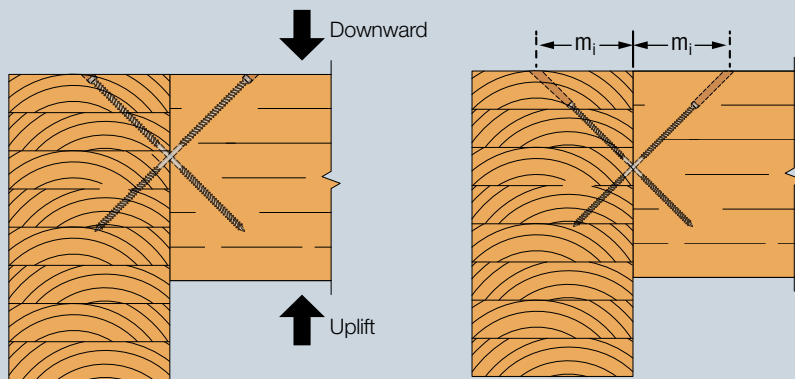

Vertical Load

For explanation of  $m_i$  see page 26.

### 3.2.3 Glulam Cross Pairs

## Solid-Drive™ ESCRFTZ Full-Threaded WOOD Screw for Cross Pairs

Yellow Zinc Plated  
C2 acc. to EN ISO 12944-2  
SC2 - 50 years acc. to EC5



ETA-13/0796

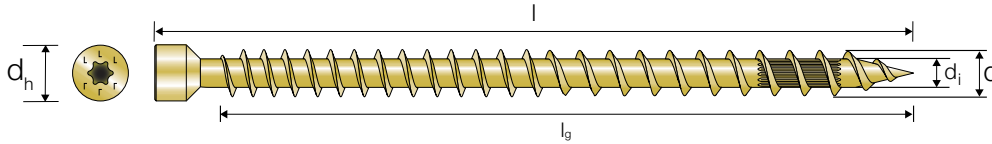

### ESCRFTZ - 45° Cross Pairs Glulam to Glulam GL24h

Product Reference	Header		Joist		Characteristic Vertical Capacity (Downward or Uplift) - GL24h			
	Min. height [mm]	Min. height [mm]	Min. width [mm]		$R_{v,k,pair} [kN] = \text{Min.}(R_{ax,k} ; R_{buck,k})$			
			1 pair	2 pairs	1 pair		2 pairs	
					$R_{ax,k}$	$R_{buck,k}$	$R_{ax,k}$	$R_{buck,k}$
ESCRFTZ8.0X120	64	128	84	124	6,72	$3.35 + 9.44 / k_{mod}$	12,53	$6.71 + 18.88 / k_{mod}$
ESCRFTZ8.0X140	64	128	84	124	8,21	$4.1 + 9.44 / k_{mod}$	15,32	$8.2 + 18.88 / k_{mod}$
ESCRFTZ8.0X160	67	128	84	124	9,70	$4.85 + 9.44 / k_{mod}$	18,10	$9.7 + 18.88 / k_{mod}$
ESCRFTZ8.0X180	74	140	84	124	11,19	$5.59 + 9.44 / k_{mod}$	20,89	$11.19 + 18.88 / k_{mod}$
ESCRFTZ8.0X200	81	154	84	124	12,69	$6.34 + 9.44 / k_{mod}$	23,67	$12.68 + 18.88 / k_{mod}$
ESCRFTZ8.0X220	88	168	84	124	14,18	$7.08 + 9.44 / k_{mod}$	26,46	$14.17 + 18.88 / k_{mod}$
ESCRFTZ8.0X240	95	182	84	124	15,67	$7.83 + 9.44 / k_{mod}$	29,24	$15.67 + 18.88 / k_{mod}$
ESCRFTZ8.0X260	102	196	84	124	17,16	$8.58 + 9.44 / k_{mod}$	32,03	$17.16 + 18.88 / k_{mod}$
ESCRFTZ8.0X280	109	210	84	124	18,66	$9.32 + 9.44 / k_{mod}$	34,81	$18.65 + 18.88 / k_{mod}$
ESCRFTZ8.0X300	117	225	84	124	20,15	$10.07 + 9.44 / k_{mod}$	37,60	$20.14 + 18.88 / k_{mod}$
ESCRFTZ8.0X350	134	260	84	124	23,88	$11.93 + 9.44 / k_{mod}$	44,56	$23.87 + 18.88 / k_{mod}$
ESCRFTZ8.0X400	152	295	84	124	27,61	$13.8 + 9.44 / k_{mod}$	51,52	$27.6 + 18.88 / k_{mod}$

Min. between  $R_{w,k,pair}$  and  $R_{buck,k,pair}$

Values in the table are valid for predrilled and non predrilled installation.

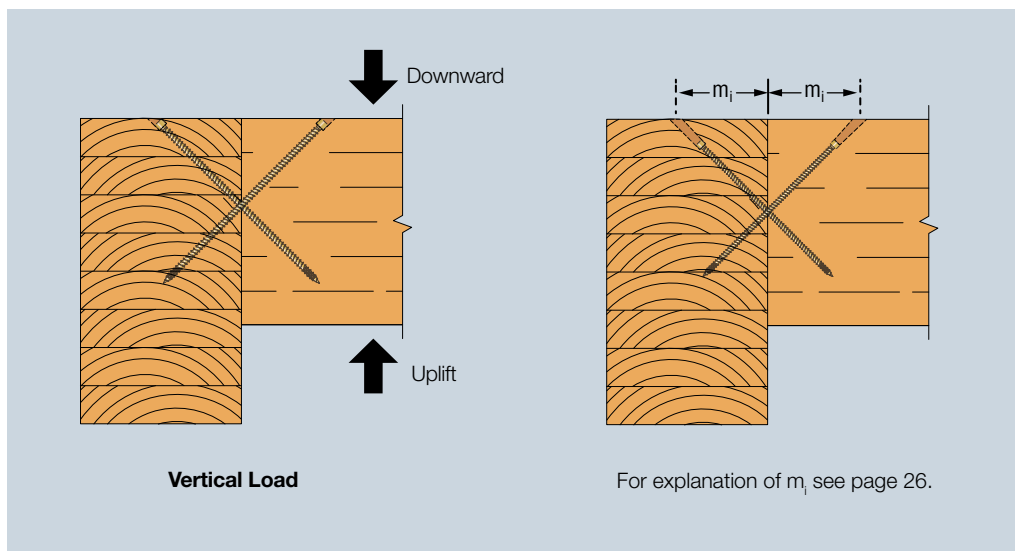

### 3.2.3 Glulam Cross Pairs

## Solid-Drive™ ESCRFT Full-Threaded WOOD Screw for Cross Pairs

Yellow Zinc Plated  
C2 acc. to EN ISO 12944-2  
SC2 - 50 years acc. to EC5



ETA-13/0796

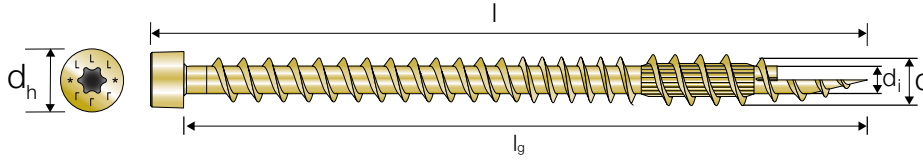

### ESCRFT - 45° Cross Pairs Glulam to Glulam GL24h

Product Reference	Header		Joist		Characteristic Vertical Capacity (Downward or Uplift) - GL24h			
	Min. height [mm]	Min. height [mm]	Min. width [mm]		$R_{v,k, pair} [kN] = \text{Min.}(R_{ax,k}; R_{buck,k})$			
			1 pair	2 pairs	1 pair		2 pairs	
					$R_{ax,k}$	$R_{buck,k}$	$R_{ax,k}$	$R_{buck,k}$
ESCRFT10.0x450	170	331	105	155	33,64	$16.82 + 13.23 / k_{mod}$	62,78	$33.64 + 26.46 / k_{mod}$
ESCRFT10.0x500	187	366	105	155	38,09	$19.04 + 13.23 / k_{mod}$	71,08	$38.09 + 26.46 / k_{mod}$
ESCRFT10.0x600	223	437	105	155	46,99	$23.49 + 13.23 / k_{mod}$	87,69	$46.99 + 26.46 / k_{mod}$
ESCRFT10.0x800	293	578	105	155	52,78	$26.39 + 13.23 / k_{mod}$	98,49	$52.78 + 26.46 / k_{mod}$
ESCRFT10.0x1000	364	719	105	155	52,78	$26.39 + 13.23 / k_{mod}$	98,49	$52.78 + 26.46 / k_{mod}$

Min. between  $R_{w,k, pair}$  and  $R_{buck,k, pair}$

Values in the table are valid for predrilled and non predrilled installation.

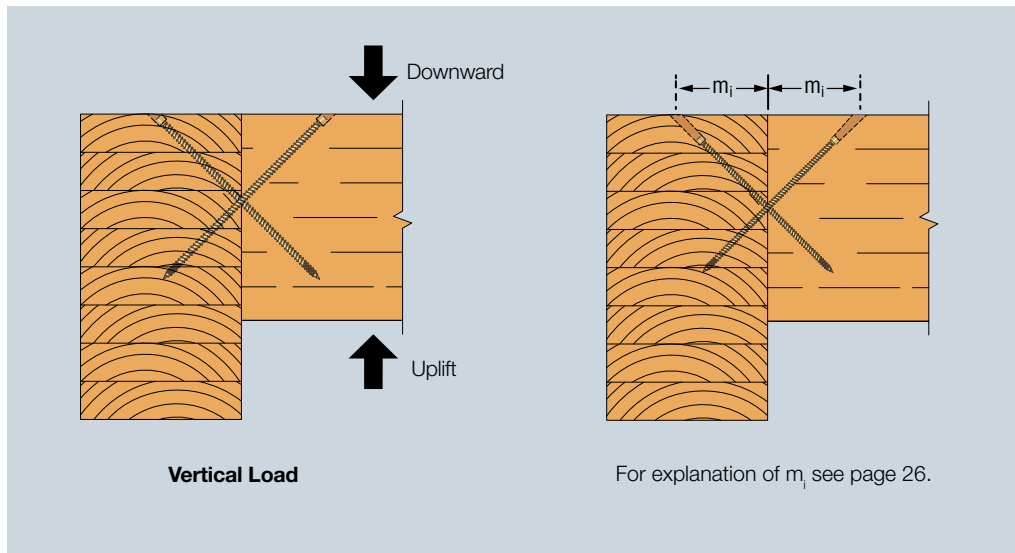

## 3.2.4 Glulam Reinforcement

### Glulam Seat Reinforcement

Glulam elements can transfer large vertical loads on bearings. In many situations the support element might have a much higher compression resistance than the glulam element. This is the case for concrete or steel supports. This might even happen for glulam post supports as the timber compression resistance parallel to the grain is much higher than it is perpendicular to the grain.

Normally designers might increase the width of the glulam element to create a bigger area of contact. However, an efficient alternative solution to this is to reinforce the seat area with full-threaded screws, that can take over the compression forces. A steel plate is needed to distribute the forces from screws onto the bearing. ESCRFT screws are highly suitable for reinforcing glulam and the values for this screw will be presented on the following pages.

See calculation example on page 170.

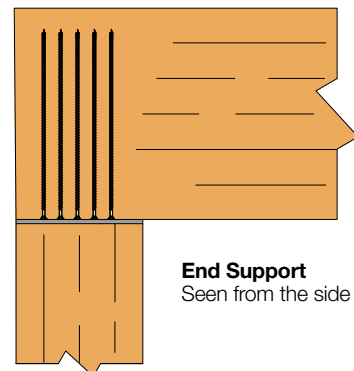
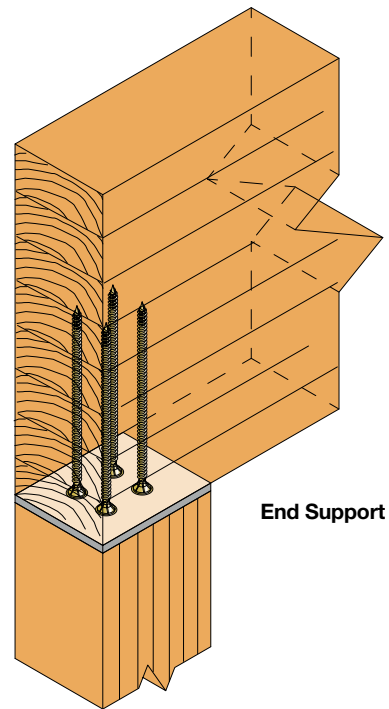
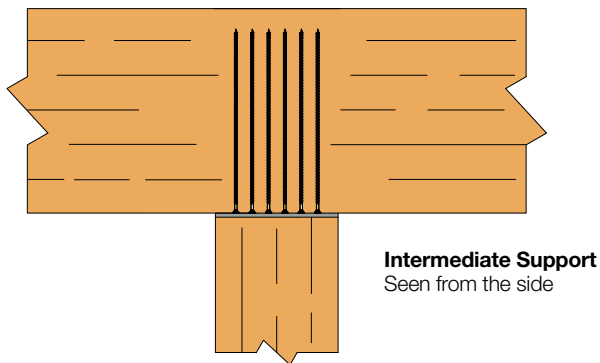

## Other Types of Timber Reinforcement

### Beam Reinforcement

Full-threaded screw can be used to reinforce an old beam by applying a new beam on top and simply installing the screws through both beams with a 45° angle.

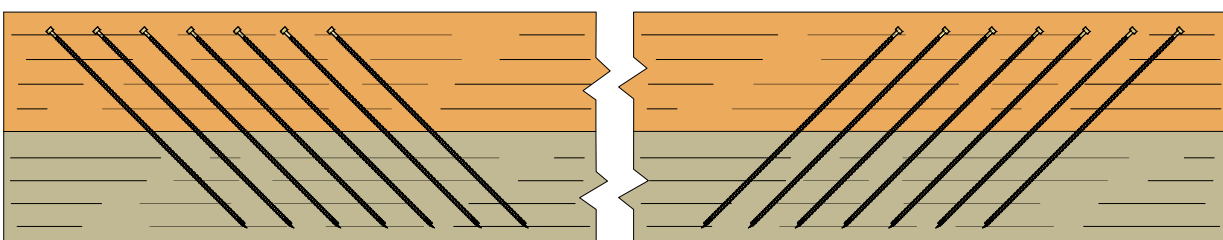



## 3.2.4 Glulam Reinforcement

### Hole Reinforcement

When a hole is made in a beam, in case of shear load, some cracks may appear. To prevent that, full-threaded screws may be used.

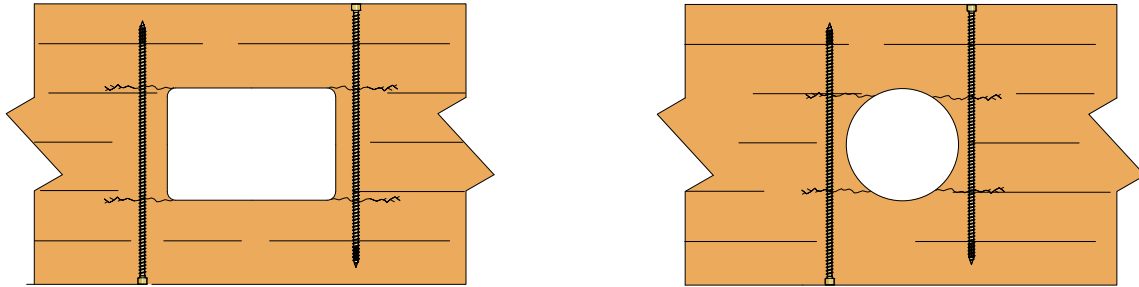

### Dowel Reinforcement

In a steel-to-wood connection made with dowels, full threaded screws can be used to reinforce the glulam beam in order to avoid splitting.

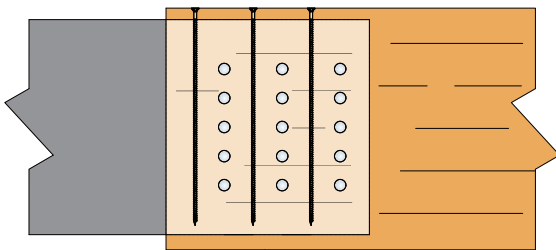

### Notch Reinforcement

To avoid splitting of the joist it can be reinforced. For that the principle is to have screws with the same length of thread on each side of the notch.

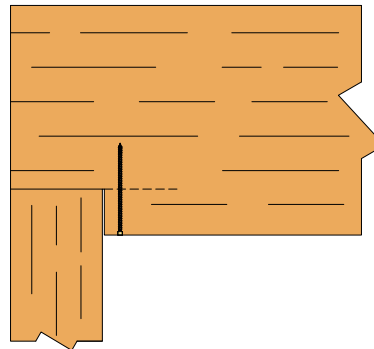

### Glulam Arcs Apex Reinforcement

In large glulam arcs under vertical load delamination of lamellas may appear. This is subject of p 6.4.3. of Eurocode 5. Structural calculation might often require to increase the width of the whole element. An alternative solution is to reinforcement the apex area with full-threaded screws. This solution is much more cost effective compared to the increasing the width of the element.

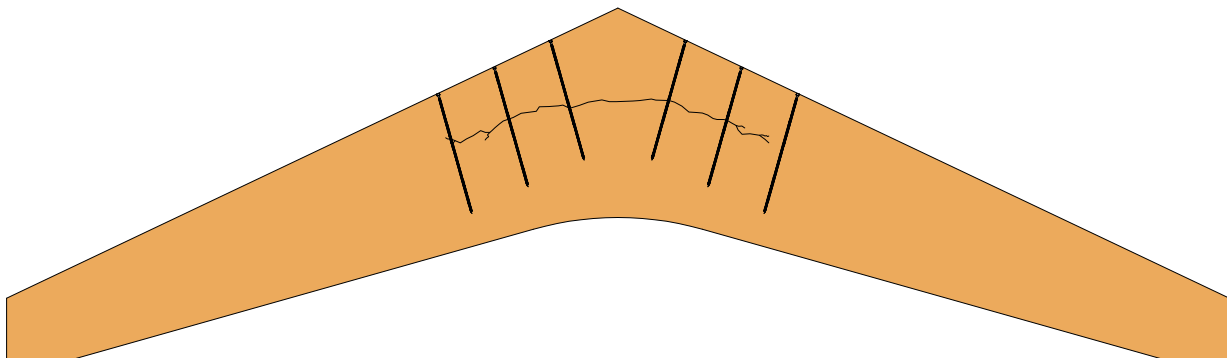

## 3.2.4 Glulam Reinforcement

### Calculation Example - Seat Reinforcement

#### Timber Properties

Timber strength class GL24h

Height:  $h = 450 \text{ mm}$  Width:  $B = 130 \text{ mm}$  Support section length:  $l = 160 \text{ mm}$

Characteristic compressive strength perpendicular to grain acc. to EN14080:  $f_{c,90,k} = 2,50 \text{ N/mm}^2$

Characteristic density:  $\rho_k = 385 \text{ kg/m}^3$

#### Loads

Combined vertical load on support (acc. To EN1991-1-1)  $F_{c,90,d} = 60,00 \text{ kN}$   $k_{mod} = 0,8$   $\gamma_m = 1,25$

with:  $l_{ef,1} = l + 30 \text{ mm}$  effective contact length according to EN 1995-1-1, 6.1.5

#### Timber capacity checking

Compressive stress perpendicular to grain checking according to 1995-1-1:2004+A2:2014:

Timber design compressive capacity perpendicular to grain  $f_{c,90,d} = f_{c,90,k} \times k_{mod} / \gamma_m = 1,60 \text{ N/mm}^2$

$$R_{timber,c,90,d} = B \times l_{ef,1} \times f_{c,90,d} = 130 \text{ mm} \times 160 + 30 \text{ mm} \times 1,6 \text{ kN/mm}^2 = 39,52 \text{ kN} < 60 \text{ kN}$$

Timber support section is insufficient, **reinforcement needed.**

#### Screw choice & properties

ESCRFTC10.0x240  $n = 4 \text{ Units}$   $L = 240 \text{ mm}$   $l_{base} = 100 \text{ mm}$

Screw head shall be flush with timber surface, and fulfill min. spacing and edge distances

Screw design thread axial capacity per screw according to ETA section:

$$F_{ax,90,d} = f_{ax,calc,k} \times d \times l_{ef} \times \frac{k_{mod}}{\gamma_{m,f}} = 12,68 \text{ N/mm}^2 \times 10 \text{ mm} \times 228 \text{ mm} \times \frac{0,8}{1,3} = 17,79 \text{ kN}$$

with:  $l_{ef}$  thread length  $\gamma_{m,f}$  partial safety factor for fasteners  $d$  screw thread diameter

$f_{ax,calc,k}$  char. withdrawal parameter in GL24h

Characteristic value of the plastic normal force load bearing capacity of the diam 10 screw net crosssection acc. to ETA section A.7.1.5

$$N_{pl,k} = \frac{\pi \times d_i^2}{4} \times f_{y,k} = \frac{\pi \times 6,3^2 \text{ mm}^2}{4} \times 950 \text{ N/mm}^2 = 29,61 \text{ kN}$$

with:  $d_i$  screw inner diameter  $f_{y,k}$  screw characteristic yield strength

#### Reinforced timber capacity checking

Design resistance of reinforced contact area according to ETA-13/0796 section A.9.1

$$R_{c,90,d} = \min \left( k_{c,90} \times B \times l_{eff,1} \times f_{c,90,d} + n \times \min \left( F_{ax,90,d}; \frac{K_c \times N_{pl,k}}{\gamma_{m1}} \right); B \times l_{eff,2} \times f_{c,90,d} \right)$$

with:

$l_{eff,2} = l_{base} + L$  effective contact length in the plane of the screw tips

$\gamma_{m1}$  partial safety factor according to EN 1993-1-1

$K_c$  slenderness ratio

$$R_{c,90,d} = \min \left( 1,75 \times 130 \text{ mm} \times 190 \text{ mm} \times 1,60 \text{ N/mm}^2 + 4 \times \min \left( 17,76 \text{ kN}; \frac{0,6 \times 29,61 \text{ kN}}{1} \right); 130 \text{ mm} \times 340 \text{ mm} \times 1,60 \text{ N/mm}^2 \right)$$

$$R_{c,90,d} = 70,72 \text{ kN} > 60 \text{ kN} \quad \text{Reinforcement is ok}$$

#### Steel plate

Grade S235  $f_{y,steel,k} = 235 \text{ N/mm}^2$

Minimum steel plate thickness according to EN1993:

$$t_{min} = \sqrt{\frac{3 \times \gamma_{m1} \times R_{c,90,d}}{\pi \times f_{y,steel,k}}} = \sqrt{\frac{3 \times 1 \times 17540}{\pi \times 235}} = 8,44 \approx 9 \text{ mm}$$

#### Notes:

Support length and width correspond to dimensions of the plate in contact with solid timber or glulam and includes minimum distance from screw to steel plate edge or to timber end and edge. For CLT or other screw configurations, please refer to ETA provisions or tables.

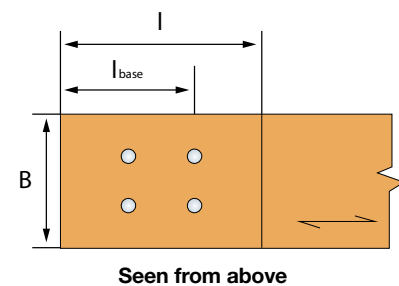
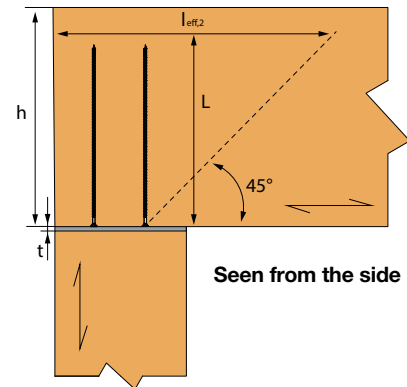

### 3.2.4 Glulam Reinforcement

## Solid-Drive™ ESCRFTC Full-Threaded WOOD Screw for Seat Reinforcement

Yellow Zinc Plated  
C2 acc. to EN ISO 12944-2  
SC2 - 50 years acc. to EC5



ETA-13/0796

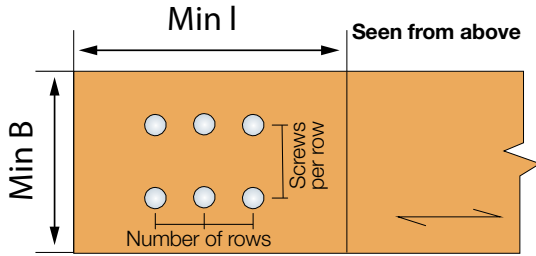

**Note:** In the above example, the reinforcement has 3 rows with 2 screws per row.

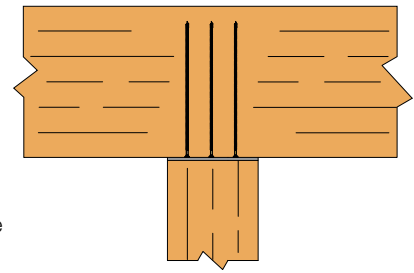
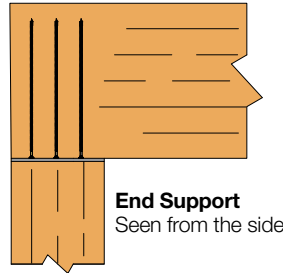

### ESCRFTC - Seat Reinforcement Glulam to Glulam GL24h - $k_{mod}=0.6$

Product Reference	Intermediate Support $R_{c,d,90}$ [kN]							End Support $R_{c,d,90}$ [kN]					Min. Thickness t of the Steel Plate [mm]		
	Min. l [mm]	Number of Rows	Min. B [mm]					Min. l [mm]	Number of Rows	Min. B [mm]					
			64	104	144	184	224			52	92	132		172	212
			Screw Qty per Row							Screw Qty per Row					
		1	2	3	4	5			1	2	3	4	5		
ESCRFTC8.0X160	27	1	17,5	27,6	30,7	33,8	36,9	53	1	15,4	18,4	21,5	24,6	27,6	6,0
	67	2	31,3	44,9	49,9	54,9	59,9	93	2	25,0	30,0	34,9	39,9	44,9	6,0
	107	3	45,2	62,2	69,1	76,0	82,9	133	3	34,6	41,5	48,4	55,3	62,2	6,0
	147	4	59,0	79,5	88,3	97,2	106,0	173	4	44,2	53,0	61,8	70,7	79,5	6,0
	187	5	72,8	96,8	107,5	118,3	129,0	213	5	53,8	64,5	75,3	86,0	96,8	6,0
ESCRFTC8.0X220	30	1	21,6	36,9	39,9	43,0	46,1	55	1	20,0	23,0	26,1	29,2	32,3	7,0
	70	2	39,2	59,9	64,9	69,9	74,9	95	2	32,4	37,4	42,4	47,4	52,4	7,0
	110	3	56,9	82,9	89,9	96,8	103,7	135	3	44,9	51,8	58,8	65,7	72,6	7,0
	150	4	74,5	106,0	114,8	123,6	132,5	175	4	57,4	66,2	75,1	83,9	92,7	7,0
	190	5	92,1	129,0	139,8	150,5	161,3	215	5	69,9	80,6	91,4	102,1	112,9	7,0
ESCRFTC8.0X240	30	1	21,8	37,5	43,0	46,1	49,2	55	1	21,1	24,6	27,6	30,7	33,8	7,0
	70	2	39,6	64,9	69,9	74,9	79,9	95	2	34,9	39,9	44,9	49,9	54,9	7,0
	110	3	57,3	89,9	96,8	103,7	110,6	135	3	48,4	55,3	62,2	69,1	76,0	7,0
	150	4	75,1	114,8	123,6	132,5	141,3	175	4	61,8	70,7	79,5	88,3	97,2	7,0
	190	5	92,9	139,8	150,5	161,3	172,0	215	5	75,3	86,0	96,8	107,5	118,3	7,0
ESCRFTC8.0X260	30	1	21,8	37,5	46,1	49,2	52,2	55	1	21,1	26,1	29,2	32,3	35,3	7,0
	70	2	39,6	69,3	74,9	79,9	84,9	95	2	37,4	42,4	47,4	52,4	57,4	7,0
	110	3	57,3	96,8	103,7	110,6	117,5	135	3	51,8	58,8	65,7	72,6	79,5	7,0
	150	4	75,1	123,6	132,5	141,3	150,1	175	4	66,2	75,1	83,9	92,7	101,6	7,0
	190	5	92,9	150,5	161,3	172,0	182,8	215	5	80,6	91,4	102,1	112,9	123,6	7,0
ESCRFTC8.0X280	30	1	21,8	37,5	49,2	52,2	55,3	55	1	21,1	27,6	30,7	33,8	36,9	7,0
	70	2	39,6	69,3	79,9	84,9	89,9	95	2	38,4	44,9	49,9	54,9	59,9	7,0
	110	3	57,3	101,1	110,6	117,5	124,4	135	3	55,3	62,2	69,1	76,0	82,9	7,0
	150	4	75,1	132,5	141,3	150,1	159,0	175	4	70,7	79,5	88,3	97,2	106,0	7,0
	190	5	92,9	161,3	172,0	182,8	193,5	215	5	86,0	96,8	107,5	118,3	129,0	7,0

This table continues on next page.  
Values in the table are valid for predrilled and non predrilled installation.

### 3.2.4 Glulam Reinforcement

ESCRFTC - Seat Reinforcement  
 Glulam to Glulam GL24h -  $k_{mod}=0.6$  (continued)

Product Reference	Intermediate Support $R_{c,d,90}$ [kN]							End Support $R_{c,d,90}$ [kN]							Min. Thickness of the Steel Plate [mm]
	Min. l [mm]	Number of Rows	Min. B [mm]					Min. l [mm]	Number of Rows	Min. B [mm]					
			64	104	144	184	224			52	92	132	172	212	
			Screw Qty per Row							Screw Qty per Row					
		1	2	3	4	5			1	2	3	4	5		
ESCRFTC8.0X300	30	1	21,8	37,5	52,2	55,3	58,4	55	1	21,1	29,2	32,3	35,3	38,4	7,0
	70	2	39,6	69,3	84,9	89,9	94,8	95	2	38,4	47,4	52,4	57,4	62,4	7,0
	110	3	57,3	101,1	117,5	124,4	131,3	135	3	55,7	65,7	72,6	79,5	86,4	7,0
	150	4	75,1	132,9	150,1	159,0	167,8	175	4	73,1	83,9	92,7	101,6	110,4	7,0
	190	5	92,9	164,7	182,8	193,5	204,3	215	5	90,4	102,1	112,9	123,6	134,4	7,0
ESCRFTC8.0X350	30	1	21,8	37,5	53,2	63,0	66,0	55	1	21,1	33,0	36,1	39,2	42,2	7,0
	70	2	39,6	69,3	97,3	102,3	107,3	95	2	38,4	53,7	58,7	63,6	68,6	7,0
	110	3	57,3	101,1	134,8	141,7	148,6	135	3	55,7	74,3	81,2	88,1	95,0	7,0
	150	4	75,1	132,9	172,2	181,1	189,9	175	4	73,1	94,9	103,8	112,6	121,4	7,0
	190	5	92,9	164,7	209,7	220,4	231,2	215	5	90,4	115,6	126,3	137,1	147,8	7,0
ESCRFTC10.0X240	34	1	28,2	49,6	55,7	60,5	65,3	67	1	27,8	32,6	37,4	42,2	47,0	8,0
	84	2	51,1	82,7	90,5	98,3	106,1	117	2	45,2	53,0	60,8	68,6	76,4	8,0
	134	3	74,1	114,5	125,3	136,1	146,9	167	3	62,6	73,4	84,2	95,0	105,8	8,0
	184	4	97,0	146,3	160,1	173,9	187,7	217	4	80,0	93,8	107,6	121,4	135,2	8,0
	234	5	119,9	178,1	194,9	211,7	228,5	267	5	97,4	114,2	131,0	147,8	164,6	8,0
ESCRFTC10.0X260	34	1	29,4	52,1	59,5	64,3	69,1	67	1	29,6	34,6	39,4	44,2	49,0	8,0
	84	2	53,6	88,9	96,7	104,5	112,3	117	2	48,4	56,2	64,0	71,8	79,6	8,0
	134	3	77,8	123,1	133,9	144,7	155,5	167	3	67,0	77,8	88,6	99,4	110,2	8,0
	184	4	102,0	157,3	171,1	184,9	198,7	217	4	85,6	99,4	113,2	127,0	140,8	8,0
	234	5	126,2	191,5	208,3	225,1	241,9	267	5	104,2	121,0	137,8	154,6	171,4	8,0
ESCRFTC10.0X280	34	1	31,3	55,2	63,4	68,2	73,0	67	1	31,2	36,5	41,3	46,1	50,9	9,0
	84	2	57,2	95,2	103,0	110,8	118,6	117	2	51,5	59,3	67,1	74,9	82,7	9,0
	134	3	83,0	131,8	142,6	153,4	164,2	167	3	71,3	82,1	92,9	103,7	114,5	9,0
	184	4	108,9	168,4	182,2	196,0	209,8	217	4	91,1	104,9	118,7	132,5	146,3	9,0
	234	5	134,7	205,0	221,8	238,6	255,4	267	5	110,9	127,7	144,5	161,3	178,1	9,0
ESCRFTC10.0X300	34	1	32,6	57,7	67,2	72,0	76,8	67	1	32,5	38,4	43,2	48,0	52,8	9,0
	84	2	59,7	101,4	109,2	117,0	124,8	117	2	54,6	62,4	70,2	78,0	85,8	9,0
	134	3	86,8	140,4	151,2	162,0	172,8	167	3	75,6	86,4	97,2	108,0	118,8	9,0
	184	4	113,9	179,4	193,2	207,0	220,8	217	4	96,6	110,4	124,2	138,0	151,8	9,0
	234	5	141,0	218,4	235,2	252,0	268,8	267	5	117,6	134,4	151,2	168,0	184,8	9,0
ESCRFTC10.0X350	34	1	33,1	58,8	76,8	81,6	86,4	67	1	33,0	43,2	48,0	52,8	57,6	9,0
	84	2	60,7	109,4	124,8	132,6	140,4	117	2	60,5	70,2	78,0	85,8	93,6	9,0
	134	3	88,4	159,9	172,8	183,6	194,4	167	3	86,4	97,2	108,0	118,8	129,6	9,0
	184	4	116,0	207,0	220,8	234,6	248,4	217	4	110,4	124,2	138,0	151,8	165,6	9,0
	234	5	143,6	252,0	268,8	285,6	302,4	267	5	134,4	151,2	168,0	184,8	201,6	9,0
ESCRFTC10.0X400	34	1	33,1	58,8	84,4	91,2	96,0	67	1	33,0	48,0	52,8	57,6	62,4	9,0
	84	2	60,7	109,4	140,4	148,2	156,0	117	2	60,5	78,0	85,8	93,6	101,4	9,0
	134	3	88,4	159,9	194,4	205,2	216,0	167	3	88,1	108,0	118,8	129,6	140,4	9,0
	184	4	116,0	210,5	248,4	262,2	276,0	217	4	115,6	138,0	151,8	165,6	179,4	9,0
	234	5	143,6	261,1	302,4	319,2	336,0	267	5	143,2	168,0	184,8	201,6	218,4	9,0

This table continues on next page.  
 Values in the table are valid for predrilled and non predrilled installation.

## 3.2.4 Glulam Reinforcement

ESCRFTC - Seat Reinforcement  
Glulam to Glulam GL24h -  $k_{mod}=0.6$  (continued)

Product Reference	Intermediate Support $R_{c,d,90}$ [kN]							End Support $R_{c,d,90}$ [kN]							Min. Thickness t of the Steel Plate [mm]
	Min. l [mm]	Number of Rows	Min. B [mm]					Min. l [mm]	Number of Rows	Min. B [mm]					
			64	104	144	184	224			52	92	132	172	212	
			Screw Qty per Row							Screw Qty per Row					
		1	2	3	4	5			1	2	3	4	5		
ESCRFTC12.0X260	38	1	33,7	60,1	73,7	80,6	87,6	79	1	35,2	43,8	50,7	57,6	64,5	9,0
	98	2	60,7	108,6	119,8	131,0	142,3	139	2	59,9	71,1	82,4	93,6	104,8	9,0
	158	3	87,8	150,3	165,9	181,4	197,0	199	3	82,9	98,5	114,0	129,6	145,2	9,0
	218	4	114,8	192,1	212,0	231,8	251,7	259	4	106,0	125,9	145,7	165,6	185,5	9,0
	278	5	141,9	233,9	258,0	282,2	306,4	319	5	129,0	153,2	177,4	201,6	225,8	9,0
ESCRFTC12.0X280	38	1	35,0	62,8	78,3	85,2	92,2	79	1	36,6	46,1	53,0	59,9	66,8	9,0
	98	2	63,4	115,1	127,3	138,5	149,8	139	2	63,6	74,9	86,1	97,3	108,6	9,0
	158	3	91,8	160,7	176,3	191,8	207,4	199	3	88,1	103,7	119,2	134,8	150,3	9,0
	218	4	120,2	205,3	225,2	245,1	265,0	259	4	112,6	132,5	152,4	172,2	192,1	9,0
	278	5	148,6	250,0	274,2	298,4	322,6	319	5	137,1	161,3	185,5	209,7	233,9	9,0
ESCRFTC12.0X300	38	1	36,3	65,4	82,9	89,9	96,8	79	1	37,9	48,4	55,3	62,2	69,1	9,0
	98	2	66,1	120,4	134,8	146,0	157,2	139	2	67,4	78,6	89,9	101,1	112,3	9,0
	158	3	95,8	171,1	186,6	202,2	217,7	199	3	93,3	108,9	124,4	140,0	155,5	9,0
	218	4	125,5	218,6	238,5	258,3	278,2	259	4	119,2	139,1	159,0	178,8	198,7	9,0
	278	5	155,3	266,1	290,3	314,5	338,7	319	5	145,2	169,3	193,5	217,7	241,9	9,0
ESCRFTC12.0X350	38	1	39,9	71,9	94,5	101,4	108,3	79	1	41,1	54,1	61,1	68,0	74,9	10,0
	98	2	73,0	132,9	153,5	164,7	176,0	139	2	74,9	88,0	99,2	110,4	121,7	10,0
	158	3	106,0	194,0	212,5	228,1	243,6	199	3	106,3	121,8	137,4	152,9	168,5	10,0
	218	4	139,1	251,7	271,6	291,5	311,3	259	4	135,8	155,7	175,5	195,4	215,3	10,0
	278	5	172,1	306,4	330,6	354,8	379,0	319	5	165,3	189,5	213,7	237,9	262,1	10,0
ESCRFTC12.0X400	38	1	39,9	71,9	103,8	112,9	119,8	79	1	41,1	59,9	66,8	73,7	80,6	10,0
	98	2	73,0	132,9	172,2	183,5	194,7	139	2	74,9	97,3	108,6	119,8	131,0	10,0
	158	3	106,0	194,0	238,5	254,0	269,6	199	3	108,7	134,8	150,3	165,9	181,4	10,0
	218	4	139,1	255,1	304,7	324,6	344,4	259	4	142,5	172,2	192,1	212,0	231,8	10,0
	278	5	172,1	316,2	370,9	395,1	419,3	319	5	176,2	209,7	233,9	258,0	282,2	10,0
ESCRFTC12.0X500	38	1	39,9	71,9	103,8	135,7	142,8	79	1	41,1	71,4	78,3	85,2	92,2	10,0
	98	2	73,0	132,9	192,9	220,9	232,1	139	2	74,9	116,1	127,3	138,5	149,8	10,0
	158	3	106,0	194,0	282,0	305,9	321,4	199	3	108,7	160,7	176,3	191,8	207,4	10,0
	218	4	139,1	255,1	370,9	390,8	410,7	259	4	142,5	205,3	225,2	245,1	265,0	10,0
	278	5	172,1	316,2	451,6	475,8	500,0	319	5	176,2	250,0	274,2	298,4	322,6	10,0

For dimensions and calculation parameters see p. 56.  
Values in the table are valid for predrilled and non predrilled installation.

### 3.2.4 Glulam Reinforcement

## Solid-Drive™ ESCRFTC Full-Threaded WOOD Screw for Seat Reinforcement

**Yellow Zinc Plated**  
C2 acc. to EN ISO 12944-2  
SC2 - 50 years acc. to EC5



ETA-13/0796

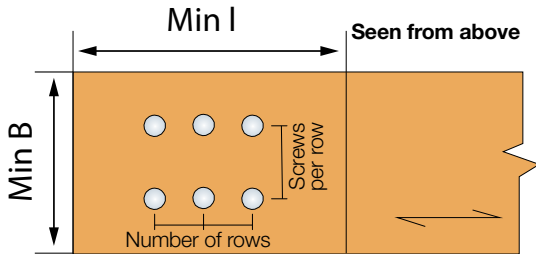

**Note:** In the above example, the reinforcement has 3 rows with 2 screws per row.

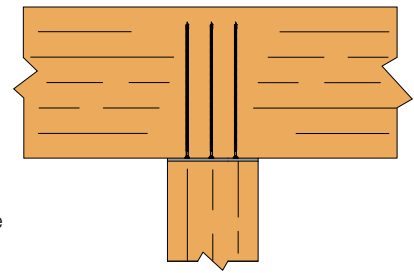
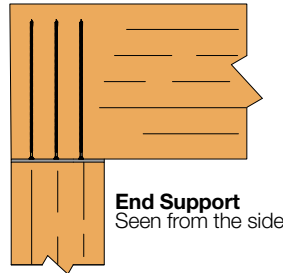

**Intermediate Support**  
Seen from the side

### ESCRFTC - Seat Reinforcement Glulam to Glulam GL24h - $k_{mod}=0.8$

Product Reference	Intermediate Support $R_{c,d.90}$ [kN]							End Support $R_{c,d.90}$ [kN]					Min. Thickness $t$ of the Steel Plate [mm]		
	Min. l [mm]	Number of Rows	Min. B [mm]					Min. l [mm]	Number of Rows	Min. B [mm]					
			64	104	144	184	224			52	92	132		172	212
			Screw Qty per Row							Screw Qty per Row					
		1	2	3	4	5			1	2	3	4	5		
ESCRFTC8.0X160	27	1	23,4	36,9	41,0	45,1	49,2	53	1	20,5	24,6	28,7	32,8	36,9	7,0
	67	2	42,0	59,9	66,6	73,2	79,9	93	2	33,3	39,9	46,6	53,2	59,9	7,0
	107	3	60,5	82,9	92,2	101,4	110,6	133	3	46,1	55,3	64,5	73,7	82,9	7,0
	147	4	79,0	106,0	117,8	129,5	141,3	173	4	58,9	70,7	82,4	94,2	106,0	7,0
	187	5	97,6	129,0	143,4	157,7	172,0	213	5	71,7	86,0	100,4	114,7	129,0	7,0
ESCRFTC8.0X220	30	1	26,6	45,1	53,2	57,3	61,4	55	1	25,6	30,7	34,8	38,9	43,0	8,0
	70	2	47,8	79,9	86,5	93,2	99,8	95	2	43,3	49,9	56,6	63,2	69,9	8,0
	110	3	69,1	110,6	119,8	129,0	138,2	135	3	59,9	69,1	78,3	87,6	96,8	8,0
	150	4	90,3	141,3	153,1	164,9	176,6	175	4	76,5	88,3	100,1	111,9	123,6	8,0
	190	5	111,6	172,0	186,4	200,7	215,0	215	5	93,2	107,5	121,9	136,2	150,5	8,0
ESCRFTC8.0X240	30	1	26,6	45,1	57,3	61,4	65,5	55	1	25,6	32,8	36,9	41,0	45,1	8,0
	70	2	47,8	82,6	93,2	99,8	106,5	95	2	46,3	53,2	59,9	66,6	73,2	8,0
	110	3	69,1	119,8	129,0	138,2	147,5	135	3	64,5	73,7	82,9	92,2	101,4	8,0
	150	4	90,3	153,1	164,9	176,6	188,4	175	4	82,4	94,2	106,0	117,8	129,5	8,0
	190	5	111,6	186,4	200,7	215,0	229,4	215	5	100,4	114,7	129,0	143,4	157,7	8,0
ESCRFTC8.0X260	30	1	26,6	45,1	61,4	65,5	69,6	55	1	25,6	34,8	38,9	43,0	47,1	8,0
	70	2	47,8	82,6	99,8	106,5	113,2	95	2	46,3	56,6	63,2	69,9	76,5	8,0
	110	3	69,1	120,1	138,2	147,5	156,7	135	3	67,0	78,3	87,6	96,8	106,0	8,0
	150	4	90,3	157,6	176,6	188,4	200,2	175	4	87,6	100,1	111,9	123,6	135,4	8,0
	190	5	111,6	195,1	215,0	229,4	243,7	215	5	107,5	121,9	136,2	150,5	164,9	8,0
ESCRFTC8.0X280	30	1	26,6	45,1	63,6	69,6	73,7	55	1	25,6	36,9	41,0	45,1	49,2	8,0
	70	2	47,8	82,6	106,5	113,2	119,8	95	2	46,3	59,9	66,6	73,2	79,9	8,0
	110	3	69,1	120,1	147,5	156,7	165,9	135	3	67,0	82,9	92,2	101,4	110,6	8,0
	150	4	90,3	157,6	188,4	200,2	212,0	175	4	87,6	106,0	117,8	129,5	141,3	8,0
	190	5	111,6	195,1	229,4	243,7	258,0	215	5	108,3	129,0	143,4	157,7	172,0	8,0

This table continues on next page.  
Values in the table are valid for predrilled and non predrilled installation.

### 3.2.4 Glulam Reinforcement

ESCRFTC - Seat Reinforcement  
 Glulam to Glulam GL24h -  $k_{mod}=0.8$  (continued)

Product Reference	Intermediate Support $R_{c,d,90}$ [kN]							End Support $R_{c,d,90}$ [kN]							Min. Thickness t of the Steel Plate [mm]
	Min. l [mm]	Number of Rows	Min. B [mm]					Min. l [mm]	Number of Rows	Min. B [mm]					
			64	104	144	184	224			52	92	132	172	212	
			Screw Qty per Row							Screw Qty per Row					
		1	2	3	4	5			1	2	3	4	5		
ESCRFTC8.0X300	30	1	26,6	45,1	63,6	73,7	77,8	55	1	25,6	38,9	43,0	47,1	51,2	8,0
	70	2	47,8	82,6	113,2	119,8	126,5	95	2	46,3	63,2	69,9	76,5	83,2	8,0
	110	3	69,1	120,1	156,7	165,9	175,1	135	3	67,0	87,6	96,8	106,0	115,2	8,0
	150	4	90,3	157,6	200,2	212,0	223,7	175	4	87,6	111,9	123,6	135,4	147,2	8,0
	190	5	111,6	195,1	243,7	258,0	272,4	215	5	108,3	136,2	150,5	164,9	179,2	8,0
ESCRFTC8.0X350	30	1	26,6	45,1	63,6	82,2	88,1	55	1	25,6	44,0	48,1	52,2	56,3	8,0
	70	2	47,8	82,6	117,4	136,4	143,1	95	2	46,3	71,6	78,2	84,9	91,5	8,0
	110	3	69,1	120,1	171,1	188,9	198,1	135	3	67,0	99,1	108,3	117,5	126,7	8,0
	150	4	90,3	157,6	224,8	241,4	253,2	175	4	87,6	126,6	138,4	150,1	161,9	8,0
	190	5	111,6	195,1	278,6	293,9	308,2	215	5	108,3	154,1	168,4	182,8	197,1	8,0
ESCRFTC10.0X240	34	1	37,4	65,9	74,2	80,6	87,0	67	1	37,1	43,5	49,9	56,3	62,7	9,0
	84	2	67,9	110,2	120,6	131,0	141,4	117	2	60,3	70,7	81,1	91,5	101,9	9,0
	134	3	98,3	152,6	167,0	181,4	195,8	167	3	83,5	97,9	112,3	126,7	141,1	9,0
	184	4	128,8	195,0	213,4	231,8	250,2	217	4	106,7	125,1	143,5	161,9	180,3	9,0
	234	5	159,3	237,4	259,8	282,2	304,6	267	5	129,9	152,3	174,7	197,1	219,5	9,0
ESCRFTC10.0X260	34	1	37,7	66,5	79,4	85,8	92,2	67	1	38,1	46,1	52,5	58,9	65,3	9,0
	84	2	68,5	118,6	129,0	139,4	149,8	117	2	64,5	74,9	85,3	95,7	106,1	9,0
	134	3	99,3	164,2	178,6	193,0	207,4	167	3	89,3	103,7	118,1	132,5	146,9	9,0
	184	4	130,0	209,8	228,2	246,6	265,0	217	4	114,1	132,5	150,9	169,3	187,7	9,0
	234	5	160,8	255,4	277,8	300,2	322,6	267	5	138,9	161,3	183,7	206,1	228,5	9,0
ESCRFTC10.0X280	34	1	37,7	66,5	84,5	90,9	97,3	67	1	38,1	48,6	55,0	61,4	67,8	9,0
	84	2	68,5	122,5	137,3	147,7	158,1	117	2	68,6	79,0	89,4	99,8	110,2	9,0
	134	3	99,3	175,7	190,1	204,5	218,9	167	3	95,0	109,4	123,8	138,2	152,6	9,0
	184	4	130,0	224,5	242,9	261,3	279,7	217	4	121,4	139,8	158,2	176,6	195,0	9,0
	234	5	160,8	273,3	295,7	318,1	340,5	267	5	147,8	170,2	192,6	215,0	237,4	9,0
ESCRFTC10.0X300	34	1	37,7	66,5	89,6	96,0	102,4	67	1	38,1	51,2	57,6	64,0	70,4	9,0
	84	2	68,5	122,5	145,6	156,0	166,4	117	2	69,1	83,2	93,6	104,0	114,4	9,0
	134	3	99,3	178,6	201,6	216,0	230,4	167	3	100,1	115,2	129,6	144,0	158,4	9,0
	184	4	130,0	234,6	257,6	276,0	294,4	217	4	128,8	147,2	165,6	184,0	202,4	9,0
	234	5	160,8	290,6	313,6	336,0	358,4	267	5	156,8	179,2	201,6	224,0	246,4	9,0
ESCRFTC10.0X350	34	1	37,7	66,5	95,4	108,8	115,2	67	1	38,1	57,6	64,0	70,4	76,8	9,0
	84	2	68,5	122,5	166,4	176,8	187,2	117	2	69,1	93,6	104,0	114,4	124,8	9,0
	134	3	99,3	178,6	230,4	244,8	259,2	167	3	100,1	129,6	144,0	158,4	172,8	9,0
	184	4	130,0	234,6	294,4	312,8	331,2	217	4	131,1	165,6	184,0	202,4	220,8	9,0
	234	5	160,8	290,6	358,4	380,8	403,2	267	5	162,1	201,6	224,0	246,4	268,8	9,0
ESCRFTC10.0X400	34	1	37,7	66,5	95,4	121,6	128,0	67	1	38,1	64,0	70,4	76,8	83,2	9,0
	84	2	68,5	122,5	176,6	197,6	208,0	117	2	69,1	104,0	114,4	124,8	135,2	9,0
	134	3	99,3	178,6	257,9	273,6	288,0	167	3	100,1	144,0	158,4	172,8	187,2	9,0
	184	4	130,0	234,6	331,2	349,6	368,0	217	4	131,1	184,0	202,4	220,8	239,2	9,0
	234	5	160,8	290,6	403,2	425,6	448,0	267	5	162,1	224,0	246,4	268,8	291,2	9,0

This table continues on next page.  
 Values in the table are valid for predrilled and non predrilled installation.



## 3.2.4 Glulam Reinforcement

ESCRFTC - Seat Reinforcement  
Glulam to Glulam GL24h -  $k_{mod}=0.8$  (continued)

Product Reference	Intermediate Support $R_{c,d,90}$ [kN]							End Support $R_{c,d,90}$ [kN]							Min. Thickness t of the Steel Plate [mm]
	Min. l [mm]	Number of Rows	Min. B [mm]					Min. l [mm]	Number of Rows	Min. B [mm]					
			64	104	144	184	224			52	92	132	172	212	
			Screw Qty per Row							Screw Qty per Row					
		1	2	3	4	5			1	2	3	4	5		
ESCRFTC12.0X260	38	1	44,5	79,8	98,3	107,5	116,7	79	1	46,8	58,4	67,6	76,8	86,0	10,0
	98	2	80,4	144,8	159,7	174,7	189,7	139	2	79,9	94,8	109,8	124,8	139,8	10,0
	158	3	116,2	200,4	221,2	241,9	262,7	199	3	110,6	131,3	152,1	172,8	193,5	10,0
	218	4	152,1	256,1	282,6	309,1	335,6	259	4	141,3	167,8	194,3	220,8	247,3	10,0
	278	5	187,9	311,8	344,1	376,3	408,6	319	5	172,0	204,3	236,5	268,8	301,1	10,0
ESCRFTC12.0X280	38	1	46,3	83,3	104,4	113,7	122,9	79	1	48,6	61,4	70,7	79,9	89,1	10,0
	98	2	83,9	152,8	169,7	184,7	199,7	139	2	84,9	99,8	114,8	129,8	144,8	10,0
	158	3	121,6	214,3	235,0	255,7	276,5	199	3	117,5	138,2	159,0	179,7	200,4	10,0
	218	4	159,2	273,8	300,3	326,8	353,3	259	4	150,1	176,6	203,1	229,6	256,1	10,0
	278	5	196,8	333,3	365,6	397,8	430,1	319	5	182,8	215,0	247,3	279,6	311,8	10,0
ESCRFTC12.0X300	38	1	47,2	85,1	110,6	119,8	129,0	79	1	49,5	64,5	73,7	82,9	92,2	10,0
	98	2	85,7	156,4	179,7	194,7	209,7	139	2	89,4	104,8	119,8	134,8	149,8	10,0
	158	3	124,2	227,6	248,8	269,6	290,3	199	3	124,4	145,2	165,9	186,6	207,4	10,0
	218	4	162,7	291,5	318,0	344,4	370,9	259	4	159,0	185,5	212,0	238,5	265,0	10,0
	278	5	201,3	354,8	387,1	419,3	451,6	319	5	193,5	225,8	258,0	290,3	322,6	10,0
ESCRFTC12.0X350	38	1	47,2	85,1	123,0	135,2	144,4	79	1	49,5	72,2	81,4	90,6	99,8	10,0
	98	2	85,7	156,4	204,7	219,6	234,6	139	2	89,4	117,3	132,3	147,3	162,2	10,0
	158	3	124,2	227,6	283,4	304,1	324,9	199	3	129,4	162,4	183,2	203,9	224,6	10,0
	218	4	162,7	298,9	362,1	388,6	415,1	259	4	169,3	207,6	234,0	260,5	287,0	10,0
	278	5	201,3	370,1	440,8	473,1	505,3	319	5	209,3	252,7	284,9	317,2	349,4	10,0
ESCRFTC12.0X400	38	1	47,2	85,1	123,0	150,5	159,7	79	1	49,5	79,9	89,1	98,3	107,5	10,0
	98	2	85,7	156,4	227,0	244,6	259,6	139	2	89,4	129,8	144,8	159,7	174,7	10,0
	158	3	124,2	227,6	318,0	338,7	359,4	199	3	129,4	179,7	200,4	221,2	241,9	10,0
	218	4	162,7	298,9	406,3	432,8	459,3	259	4	169,3	229,6	256,1	282,6	309,1	10,0
	278	5	201,3	370,1	494,6	526,8	559,1	319	5	209,3	279,6	311,8	344,1	376,3	10,0
ESCRFTC12.0X500	38	1	47,2	85,1	123,0	160,9	190,5	79	1	49,5	87,4	104,4	113,7	122,9	10,0
	98	2	85,7	156,4	227,0	294,5	309,5	139	2	89,4	154,8	169,7	184,7	199,7	10,0
	158	3	124,2	227,6	331,0	407,8	428,5	199	3	129,4	214,3	235,0	255,7	276,5	10,0
	218	4	162,7	298,9	435,0	521,1	547,6	259	4	169,3	273,8	300,3	326,8	353,3	10,0
	278	5	201,3	370,1	539,0	634,4	666,6	319	5	209,3	333,3	365,6	397,8	430,1	10,0

For dimensions and calculation parameters see p. 56.  
Values in the table are valid for predrilled and non predrilled installation.

### 3.2.4 Glulam Reinforcement

## Solid-Drive™ ESCRFTC Full-Threaded WOOD Screw for Seat Reinforcement

**Yellow Zinc Plated**  
C2 acc. to EN ISO 12944-2  
SC2 - 50 years acc. to EC5



ETA-13/0796

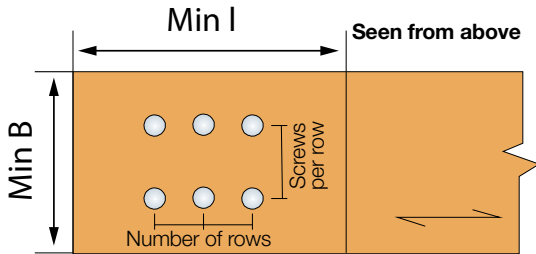

**Note:** In the above example, the reinforcement has 3 rows with 2 screws per row.

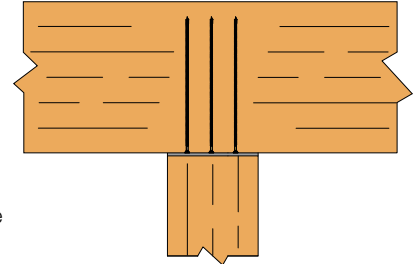
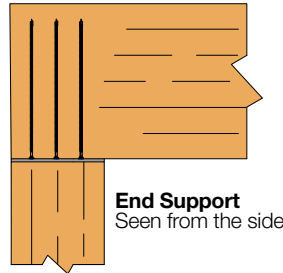

### ESCRFTC - Seat Reinforcement Glulam to Glulam GL24h - $k_{mod}=0.9$

Product Reference	Intermediate Support $R_{c,d.90}$ [kN]							End Support $R_{c,d.90}$ [kN]					Min. Thickness t of the Steel Plate [mm]		
	Min. I [mm]	Number of Rows	Min. B [mm]					Min. I [mm]	Number of Rows	Min. B [mm]					
			64	104	144	184	224			52	92	132		172	212
			Screw Qty per Row							Screw Qty per Row					
		1	2	3	4	5			1	2	3	4	5		
ESCRFTC8.0X160	27	1	25,5	41,5	46,1	50,7	55,3	53	1	23,0	27,6	32,3	36,9	41,5	7,0
	67	2	45,8	67,4	74,9	82,4	89,9	93	2	37,4	44,9	52,4	59,9	67,4	7,0
	107	3	66,2	93,3	103,7	114,0	124,4	133	3	51,8	62,2	72,6	82,9	93,3	7,0
	147	4	86,5	119,2	132,5	145,7	159,0	173	4	66,2	79,5	92,7	106,0	119,2	7,0
	187	5	106,9	145,2	161,3	177,4	193,5	213	5	80,6	96,8	112,9	129,0	145,2	7,0
ESCRFTC8.0X220	30	1	28,0	47,3	59,9	64,5	69,1	55	1	27,1	34,6	39,2	43,8	48,4	8,0
	70	2	50,2	86,2	97,3	104,8	112,3	95	2	48,7	56,2	63,6	71,1	78,6	8,0
	110	3	72,3	124,4	134,8	145,2	155,5	135	3	67,4	77,8	88,1	98,5	108,9	8,0
	150	4	94,5	159,0	172,2	185,5	198,7	175	4	86,1	99,4	112,6	125,9	139,1	8,0
	190	5	116,6	193,5	209,7	225,8	241,9	215	5	104,8	121,0	137,1	153,2	169,3	8,0
ESCRFTC8.0X240	30	1	28,0	47,3	64,5	69,1	73,7	55	1	27,1	36,9	41,5	46,1	50,7	8,0
	70	2	50,2	86,2	104,8	112,3	119,8	95	2	48,7	59,9	67,4	74,9	82,4	8,0
	110	3	72,3	125,1	145,2	155,5	165,9	135	3	70,3	82,9	93,3	103,7	114,0	8,0
	150	4	94,5	164,0	185,5	198,7	212,0	175	4	91,9	106,0	119,2	132,5	145,7	8,0
	190	5	116,6	202,8	225,8	241,9	258,0	215	5	112,9	129,0	145,2	161,3	177,4	8,0
ESCRFTC8.0X260	30	1	28,0	47,3	66,6	73,7	78,3	55	1	27,1	39,2	43,8	48,4	53,0	8,0
	70	2	50,2	86,2	112,3	119,8	127,3	95	2	48,7	63,6	71,1	78,6	86,1	8,0
	110	3	72,3	125,1	155,5	165,9	176,3	135	3	70,3	88,1	98,5	108,9	119,2	8,0
	150	4	94,5	164,0	198,7	212,0	225,2	175	4	91,9	112,6	125,9	139,1	152,4	8,0
	190	5	116,6	202,8	241,9	258,0	274,2	215	5	113,5	137,1	153,2	169,3	185,5	8,0
ESCRFTC8.0X280	30	1	28,0	47,3	66,6	78,3	82,9	55	1	27,1	41,5	46,1	50,7	55,3	8,0
	70	2	50,2	86,2	119,8	127,3	134,8	95	2	48,7	67,4	74,9	82,4	89,9	8,0
	110	3	72,3	125,1	165,9	176,3	186,6	135	3	70,3	93,3	103,7	114,0	124,4	8,0
	150	4	94,5	164,0	212,0	225,2	238,5	175	4	91,9	119,2	132,5	145,7	159,0	8,0
	190	5	116,6	202,8	258,0	274,2	290,3	215	5	113,5	145,2	161,3	177,4	193,5	8,0

This table continues on next page.  
Values in the table are valid for predrilled and non predrilled installation.

### 3.2.4 Glulam Reinforcement

ESCRFTC - Seat Reinforcement  
 Glulam to Glulam GL24h -  $k_{mod}=0.9$  (continued)

Glulam

Product Reference	Intermediate Support $R_{c,d,90}$ [kN]							End Support $R_{c,d,90}$ [kN]							Min. Thickness t of the Steel Plate [mm]
	Min. l [mm]	Number of Rows	Min. B [mm]					Min. l [mm]	Number of Rows	Min. B [mm]					
			64	104	144	184	224			52	92	132	172	212	
			Screw Qty per Row							Screw Qty per Row					
		1	2	3	4	5			1	2	3	4	5		
ESCRFTC8.0X300	30	1	28,0	47,3	66,6	82,9	87,6	55	1	27,1	43,8	48,4	53,0	57,6	8,0
	70	2	50,2	86,2	122,2	134,8	142,3	95	2	48,7	71,1	78,6	86,1	93,6	8,0
	110	3	72,3	125,1	176,3	186,6	197,0	135	3	70,3	98,5	108,9	119,2	129,6	8,0
	150	4	94,5	164,0	225,2	238,5	251,7	175	4	91,9	125,9	139,1	152,4	165,6	8,0
	190	5	116,6	202,8	274,2	290,3	306,4	215	5	113,5	153,2	169,3	185,5	201,6	8,0
ESCRFTC8.0X350	30	1	28,0	47,3	66,6	86,0	99,1	55	1	27,1	46,4	54,1	58,8	63,4	8,0
	70	2	50,2	86,2	122,2	153,5	161,0	95	2	48,7	80,5	88,0	95,5	103,0	8,0
	110	3	72,3	125,1	177,8	212,5	222,9	135	3	70,3	111,5	121,8	132,2	142,6	8,0
	150	4	94,5	164,0	233,4	271,6	284,8	175	4	91,9	142,4	155,7	168,9	182,2	8,0
	190	5	116,6	202,8	289,0	330,6	346,8	215	5	113,5	173,4	189,5	205,6	221,8	8,0
ESCRFTC10.0X240	34	1	39,6	69,6	83,5	90,7	97,9	67	1	40,2	49,0	56,2	63,4	70,6	9,0
	84	2	71,5	124,0	135,7	147,4	159,1	117	2	67,9	79,6	91,3	103,0	114,7	9,0
	134	3	103,4	171,7	187,9	204,1	220,3	167	3	94,0	110,2	126,4	142,6	158,8	9,0
	184	4	135,4	219,4	240,1	260,8	281,5	217	4	120,1	140,8	161,5	182,2	202,9	9,0
	234	5	167,3	267,1	292,3	317,5	342,7	267	5	146,2	171,4	196,6	221,8	247,0	9,0
ESCRFTC10.0X260	34	1	39,6	69,6	89,3	96,5	103,7	67	1	40,2	51,8	59,0	66,2	73,4	9,0
	84	2	71,5	127,5	145,1	156,8	168,5	117	2	72,5	84,2	95,9	107,6	119,3	9,0
	134	3	103,4	184,7	200,9	217,1	233,3	167	3	100,4	116,6	132,8	149,0	165,2	9,0
	184	4	135,4	236,0	256,7	277,4	298,1	217	4	128,3	149,0	169,7	190,4	211,1	9,0
	234	5	167,3	287,3	312,5	337,7	362,9	267	5	156,2	181,4	206,6	231,8	257,0	9,0
ESCRFTC10.0X280	34	1	39,6	69,6	95,0	102,2	109,4	67	1	40,2	54,7	61,9	69,1	76,3	9,0
	84	2	71,5	127,5	154,4	166,1	177,8	117	2	72,5	88,9	100,6	112,3	124,0	9,0
	134	3	103,4	185,4	213,8	230,0	246,2	167	3	104,9	123,1	139,3	155,5	171,7	9,0
	184	4	135,4	243,4	273,2	293,9	314,6	217	4	136,6	157,3	178,0	198,7	219,4	9,0
	234	5	167,3	301,3	332,6	357,8	383,0	267	5	166,3	191,5	216,7	241,9	267,1	9,0
ESCRFTC10.0X300	34	1	39,6	69,6	99,6	108,0	115,2	67	1	40,2	57,6	64,8	72,0	79,2	9,0
	84	2	71,5	127,5	163,8	175,5	187,2	117	2	72,5	93,6	105,3	117,0	128,7	9,0
	134	3	103,4	185,4	226,8	243,0	259,2	167	3	104,9	129,6	145,8	162,0	178,2	9,0
	184	4	135,4	243,4	289,8	310,5	331,2	217	4	137,2	165,6	186,3	207,0	227,7	9,0
	234	5	167,3	301,3	352,8	378,0	403,2	267	5	169,5	201,6	226,8	252,0	277,2	9,0
ESCRFTC10.0X350	34	1	39,6	69,6	99,6	122,4	129,6	67	1	40,2	64,8	72,0	79,2	86,4	9,0
	84	2	71,5	127,5	183,5	198,9	210,6	117	2	72,5	105,3	117,0	128,7	140,4	9,0
	134	3	103,4	185,4	259,2	275,4	291,6	167	3	104,9	145,8	162,0	178,2	194,4	9,0
	184	4	135,4	243,4	331,2	351,9	372,6	217	4	137,2	186,3	207,0	227,7	248,4	9,0
	234	5	167,3	301,3	403,2	428,4	453,6	267	5	169,5	226,8	252,0	277,2	302,4	9,0
ESCRFTC10.0X400	34	1	39,6	69,6	99,6	129,7	144,0	67	1	40,2	70,2	79,2	86,4	93,6	9,0
	84	2	71,5	127,5	183,5	222,3	234,0	117	2	72,5	117,0	128,7	140,4	152,1	9,0
	134	3	103,4	185,4	267,4	307,8	324,0	167	3	104,9	162,0	178,2	194,4	210,6	9,0
	184	4	135,4	243,4	351,4	393,3	414,0	217	4	137,2	207,0	227,7	248,4	269,1	9,0
	234	5	167,3	301,3	435,3	478,8	504,0	267	5	169,5	252,0	277,2	302,4	327,6	9,0

This table continues on next page.  
 Values in the table are valid for predrilled and non predrilled installation.

## 3.2.4 Glulam Reinforcement

ESCRFTC - Seat Reinforcement  
Glulam to Glulam GL24h -  $k_{mod}=0.9$  (continued)

Product Reference	Intermediate Support $R_{c,d.90}$ [kN]							End Support $R_{c,d.90}$ [kN]							Min. Thickness t of the Steel Plate [mm]
	Min. l [mm]	Number of Rows	Min. B [mm]					Min. l [mm]	Number of Rows	Min. B [mm]					
			64	104	144	184	224			52	92	132	172	212	
			Screw Qty per Row							Screw Qty per Row					
		1	2	3	4	5			1	2	3	4	5		
ESCRFTC12.0X260	38	1	49,5	89,1	110,6	121,0	131,3	79	1	52,3	65,7	76,0	86,4	96,8	10,0
	98	2	89,4	162,9	179,7	196,6	213,4	139	2	89,9	106,7	123,6	140,4	157,2	10,0
	158	3	129,4	225,5	248,8	272,2	295,5	199	3	124,4	147,7	171,1	194,4	217,7	10,0
	218	4	169,3	288,1	318,0	347,8	377,6	259	4	159,0	188,8	218,6	248,4	278,2	10,0
	278	5	209,3	350,8	387,1	423,4	459,6	319	5	193,5	229,8	266,1	302,4	338,7	10,0
ESCRFTC12.0X280	38	1	49,5	89,1	117,5	127,9	138,2	79	1	52,3	69,1	79,5	89,9	100,2	10,0
	98	2	89,4	162,9	190,9	207,8	224,6	139	2	94,1	112,3	129,2	146,0	162,9	10,0
	158	3	129,4	236,6	264,4	287,7	311,0	199	3	132,2	155,5	178,8	202,2	225,5	10,0
	218	4	169,3	308,0	337,8	367,6	397,4	259	4	168,9	198,7	228,5	258,3	288,1	10,0
	278	5	209,3	375,0	411,3	447,6	483,8	319	5	205,6	241,9	278,2	314,5	350,8	10,0
ESCRFTC12.0X300	38	1	49,5	89,1	124,4	134,8	145,2	79	1	52,3	72,6	82,9	93,3	103,7	10,0
	98	2	89,4	162,9	202,2	219,0	235,9	139	2	94,1	117,9	134,8	151,6	168,5	10,0
	158	3	129,4	236,6	279,9	303,3	326,6	199	3	135,8	163,3	186,6	210,0	233,3	10,0
	218	4	169,3	310,4	357,7	387,5	417,3	259	4	177,6	208,7	238,5	268,3	298,1	10,0
	278	5	209,3	384,2	435,5	471,7	508,0	319	5	217,7	254,0	290,3	326,6	362,9	10,0
ESCRFTC12.0X350	38	1	49,5	89,1	128,8	152,1	162,4	79	1	52,3	81,2	91,6	102,0	112,3	10,0
	98	2	89,4	162,9	230,3	247,1	264,0	139	2	94,1	132,0	148,8	165,7	182,5	10,0
	158	3	129,4	236,6	318,8	342,1	365,5	199	3	135,8	182,7	206,1	229,4	252,7	10,0
	218	4	169,3	310,4	407,4	437,2	467,0	259	4	177,6	233,5	263,3	293,1	322,9	10,0
	278	5	209,3	384,2	495,9	532,2	568,5	319	5	219,3	284,3	320,5	356,8	393,1	10,0
ESCRFTC12.0X400	38	1	49,5	89,1	128,8	168,4	179,7	79	1	52,3	89,9	100,2	110,6	121,0	10,0
	98	2	89,4	162,9	236,3	275,2	292,0	139	2	94,1	146,0	162,9	179,7	196,6	10,0
	158	3	129,4	236,6	343,9	381,0	404,4	199	3	135,8	202,2	225,5	248,8	272,2	10,0
	218	4	169,3	310,4	451,5	486,9	516,7	259	4	177,6	258,3	288,1	318,0	347,8	10,0
	278	5	209,3	384,2	556,4	592,7	629,0	319	5	219,3	314,5	350,8	387,1	423,4	10,0
ESCRFTC12.0X500	38	1	49,5	89,1	128,8	168,4	208,1	79	1	52,3	92,0	117,5	127,9	138,2	10,0
	98	2	89,4	162,9	236,3	309,8	348,2	139	2	94,1	167,5	190,9	207,8	224,6	10,0
	158	3	129,4	236,6	343,9	451,2	482,1	199	3	135,8	241,1	264,4	287,7	311,0	10,0
	218	4	169,3	310,4	451,5	586,2	616,0	259	4	177,6	308,0	337,8	367,6	397,4	10,0
	278	5	209,3	384,2	559,1	713,7	750,0	319	5	219,3	375,0	411,3	447,6	483,8	10,0

For dimensions and calculation parameters see p. 56.  
Values in the table are valid for predrilled and non predrilled installation.

## 3.3 CLT to CLT

### General Information about CLT Fastening

CLT is an engineered wood-based material that consists of several layers of solid wood glued together. While the flat sides of the boards are always glued together, the narrow sides can also be unglued, depending on the manufacturer. An uneven number of at least three flat layers of solid wood boards are arranged crosswise and glued together.

The odd number of board layers means that the fibres of the grain direction of the two top layers always run in the same direction. The individual board layers can be of different thicknesses, but they must be symmetrical on both sides, starting from the middle layer.

CLT is basically standardised in EN16351, but the individual products can vary in detail depending on the manufacturer. Therefore, each CLT manufacturer has its own ETA that describes their individual product.

The construction of CLT, similar to plywood, offers the advantage that swelling and shrinkage as well as splitting of the individual layers of wood is hindered by the crosswise gluing and is thereby limited to a minimum. Further advantages are the great dimensional stability and the possibility of producing enormous dimensions of a single panel spanning up to over 20 meters in length and 3,5 meters in width.

Entire building walls can be prefabricated in one piece, transported to the construction site and lifted in place with smaller cranes, thanks to the relatively low weight.

CLT can therefore be used to construct a building in a very short time without time-consuming drying or curing phases. CLT is a panel material with excellent structural static properties and allows loads to be applied in different directions. CLT can therefore be used as a wall or floor element. This means that all the advantages that solid wood has to offer can be fully taken advantage of.

These include, among other things, the simple mechanical ease to fasten, simple connection options on the construction site, favourable physical properties such as good thermal insulation, a positive influence on room

humidity and and favourable fire protection behaviour. In addition to this good ecological balance and a high CO<sub>2</sub> storage volume are important arguments for the decision to construct a building with CLT.

During the construction phase, CLT must be protected from excessive moisture penetration. The use of CLT is only approved for use in service classes 1 and 2. In case of risks of long-lasting changes in humidity in ceiling components in service class 2, extreme deformations may occur.

Different visual demands on the CLT surfaces are described by the categories: 'industrial quality' and 'visible quality'. While the industrial quality is used as a standard for many components that are later covered with cladding, the demands on the surface of a visible quality are significantly higher. When specifying, it must be exactly defined which requirements are to be fulfilled. For very high demands for visibility, the elements can be covered with thinner, so-called "3-layer plates" from the interior as a good alternative to a visible element.

In order to mechanically connect individual CLT components with other components, a number of boundary conditions must be followed and suitable connectors and fasteners must be used. On the following pages fasteners suitable for cross laminated timber elements are listed and presented.

Wood is an anisotropic material, meaning that it has different mechanical properties depending on the direction of the fibres. These properties result in the different spacing requirements for the different fasteners.

In the case of CLT, the crosswise arrangement of the individual board layers results in a reduction of the the required spacing dimensions compared to solid wood, however it cannot be assumed that a connection that works for solid timber automatically works for CLT connections as well.

### 90° T-Connections Between CLT Panels

A 90° T-connection between CLT panels is created when two CLT panels need to be fastened with each other, either in a wall-to-wall connection or in a floor-to-wall connection.

In wall-to-wall connections the SWW washer-head screw is recommended due to its extreme pull-through resistance. The washer head simply pulls the wall elements together, creating a firm assembly.

When fastening a floor-to-wall connection, 45° cross screwing with either double- or full-threaded screws is recommended.

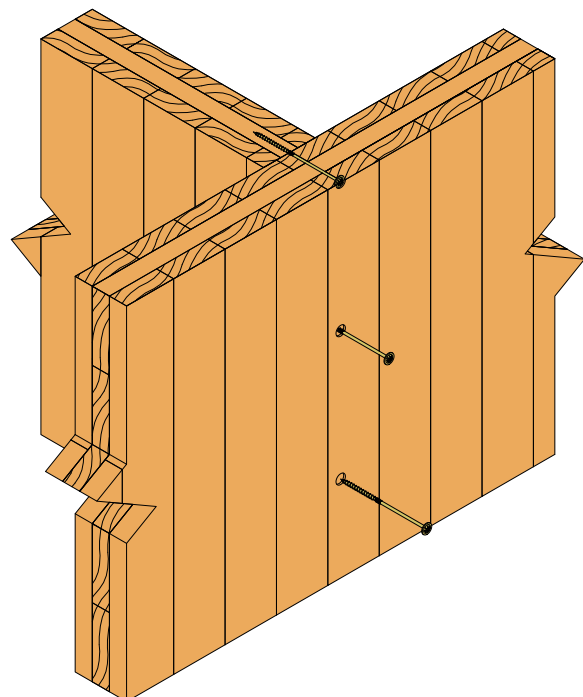
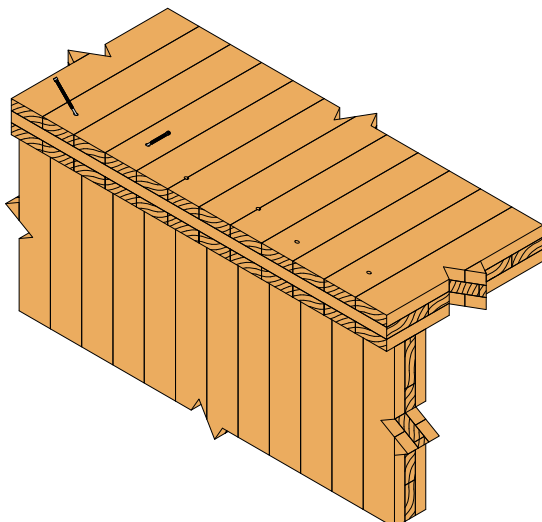

## 3.3 CLT to CLT

### Solid Timber Wall-Plate to CLT Panel

For installing a floor panel on the inside of wall panels, an effective method is to install a wall-plate to floor panel.

The wall-plate can be installed both with screws installed at 90° into the wallplate or it can be installed with a 45° inclined installation.

For 90° installation, countersunk or washer-head partially threaded screws are recommended.

For 45° installation, cylinder-head screws with either double- or full-threaded are recommended.

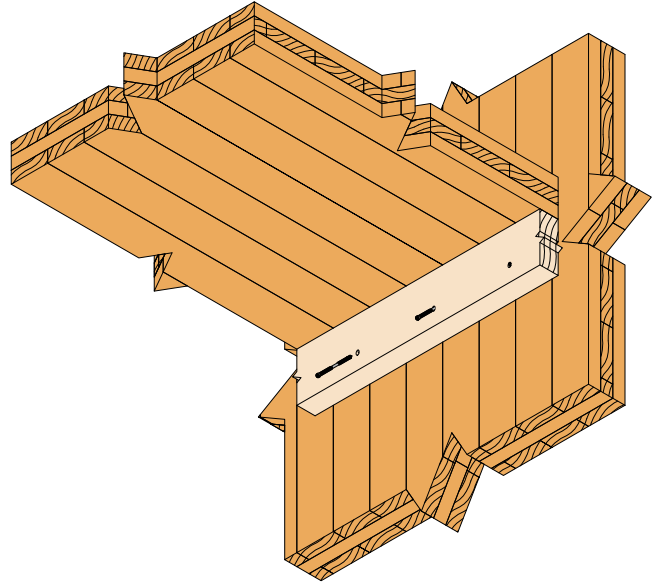

### CLT Half-Lap Connection

There are several ways of connecting floor panels that butt up against each other.

CLT panels can be ordered from the manufacturer with a cut-out to create the so-called half-lap connections. A simple method where the panels are overlapping each other and the panels can be connected with screws installed vertically 90° with either countersunk or washer-head screws.

Half-lap connections can also be made with 45° cross pairs using double- or full-thread screws.

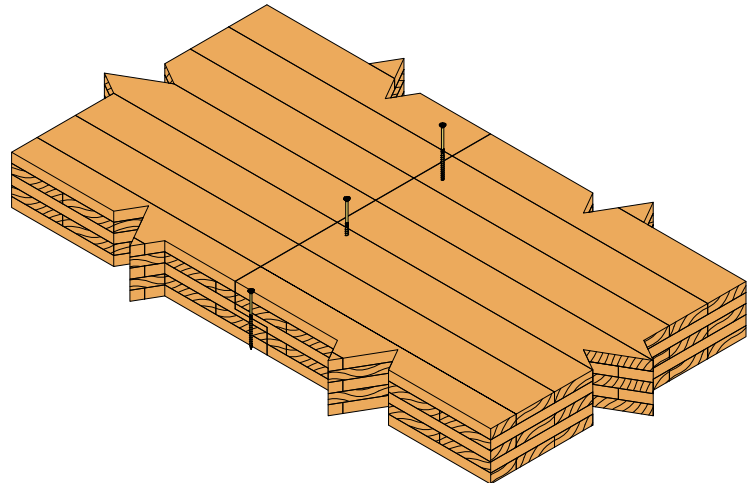

### CLT Butt-Joint Connection

Alternatively to half-lap connections, a butt-joint connection can be made. In this case, the panels are not prepared by the CLT manufacturer so the panels simply have to butt up against each other and be connected with 45° cross pairs or with angled 45° cross pairs.

In both cases, cylinder-head double- or full-threaded screws are recommended.

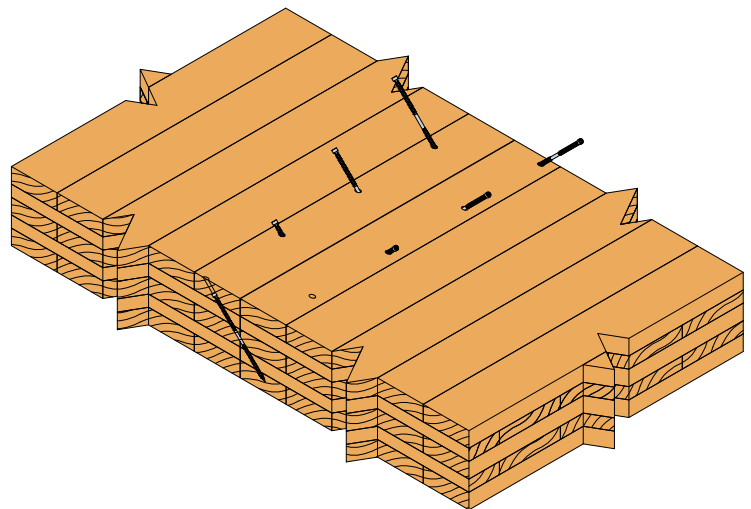

## 3.3 CLT to CLT

### Board Spline to CLT Panels

A third alternative to half-lap and butt joints are to create a spline using either boards or metal plates.

OSB and plywood boards can be used.

The CLT panels are prepared by the manufacturer with a cut-out making room for the board spline. The boards are fastening countersunk timber screws.

The Quik Drive system is very useful for this purpose as many screws can be installed with precision, in a short amount of time.

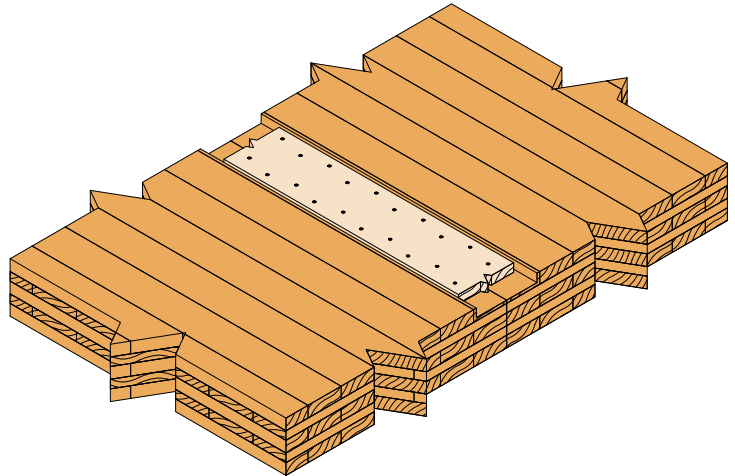

### CLT Connections Including Metal- See Chapter 'Steel to Timber'

Using steel connectors and metal plates to install CLT panels is also very common and can in many cases be a good and cost-efficient fastening method. In the chapter steel to timber you can find the values for using steel connectors to timber.

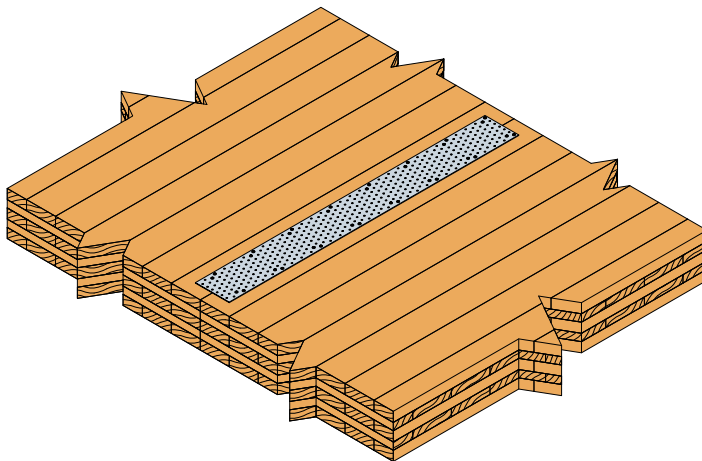

### Metal Spline to CLT Panels

In the same way as the board spline, a metal plate is used, fastened with CSA connector screws or CNA connector nails.

For CSA screws we recommend the use of the Quik Drive system that considerably eases repetitive fastening.

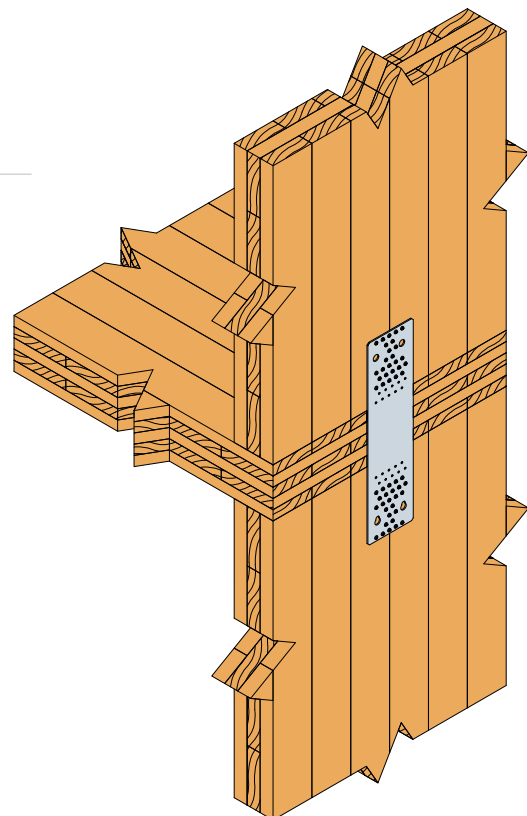

### CLT Connections made with Simpson Strong-Tie Connectors

Simpson Strong-Tie offers a range of heavy-duty CLT connectors designed to create strong connections in CLT construction.

Find out more about these applications on our website [strongtie.eu](http://strongtie.eu) or in our CLT catalogue.



### 3.3.1 90° T-Connections Between CLT Panels

## Solid-Drive™ TTUFS Countersunk WOOD Screw for T-Connections Between CLT Panels

Electro Galvanised  
C1 acc. to EN ISO 12944-2  
SC2 - 50 years acc. to EC5

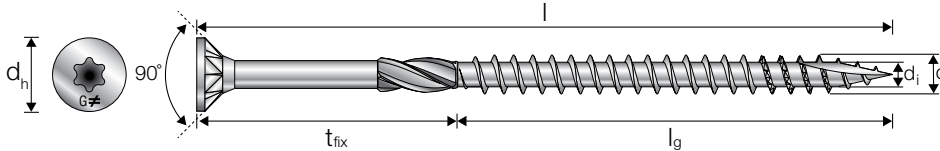

TTUFS - 90° T-Connections Between CLT Panel - Screws at 90°  
CLT to CLT  $\rho_k = 350 \text{ kg/m}^3$

Product Reference	Tension Capacity $R_{ax,k}$ Shear Capacity $R_{v,k}$ Depending on the Thickness of the Panel [kN] - Screws at 90°												
	CLT Panel Thickness $t_1$ [mm]												
	80	100	120	140	160	180	200	220	240	260	280	300	
TTUFS6.0X90	0,67	-	-	-	-	-	-	-	-	-	-	-	-
TTUFS6.0X100	1,24	-	-	-	-	-	-	-	-	-	-	-	-
TTUFS6.0X120	2,23	1,24	-	-	-	-	-	-	-	-	-	-	-
TTUFS6.0X140	2,23	2,23	1,24	-	-	-	-	-	-	-	-	-	-
TTUFS6.0X160	2,23	1,93 1,85	2,23	2,23	1,24	-	-	-	-	-	-	-	-
TTUFS6.0X180	2,23	1,93 1,85	2,23	1,93 1,85	2,23	1,24	-	-	-	-	-	-	-

For dimensions and calculation parameters see p. 40.

Tension capacity  $R_{ax,k}$

Characteristic capacities	2,23	1,93	With pre-drill
		1,85	Without pre-drill

Shear capacity  $R_{v,k}$

For pre-drilling recommendations see page 21.

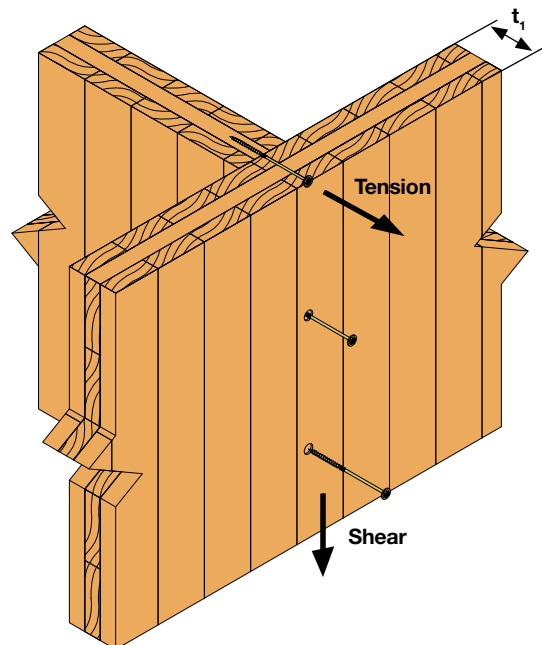

### 3.3.1 90° T-Connections Between CLT Panels

## Solid-Drive™ SWW Washer-Head WOOD Screw for T-Connections Between CLT Panels

Yellow Zinc Plated  
C2 acc. to EN ISO 12944-2  
SC2 - 50 years acc. to EC5

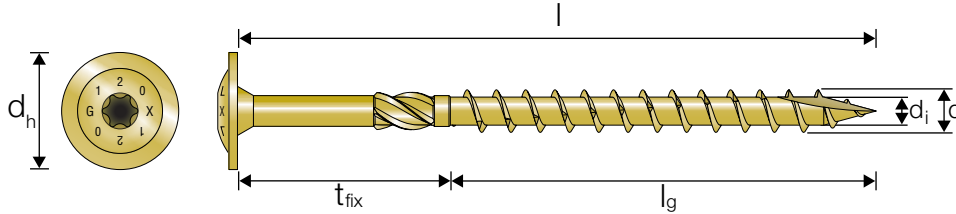

SWW - 90° T-Connection Between CLT Panels - Screws at 90°  
CLT to CLT  $\rho_k = 350 \text{ kg/m}^3$

Product Reference	Tension Capacity $R_{ax,k}$ Shear Capacity $R_{v,k}$ Depending on the Thickness of the Panel [kN] - Screws at 90°																					
	CLT Panel Thickness $t_i$ [mm]																					
	80	100	120	140	160	180	200	220	240	260	280	300										
SWW6.0X160	3,16	2,23 2,14	3,16	-	2,32	-	1,24	-	-	-	-	-	-	-	-	-	-	-	-	-	-	-
SWW6.0X180	3,16	2,23 2,14	3,16	2,23 2,14	3,16	-	2,32	-	1,24	-	-	-	-	-	-	-	-	-	-	-	-	-
SWW6.0X200	3,16	2,23 2,14	3,16	2,23 2,14	3,16	2,23 2,14	3,16	-	2,32	-	1,24	-	-	-	-	-	-	-	-	-	-	-
SWW6.0X220	3,16	2,23 2,14	3,16	2,23 2,14	3,16	2,23 2,14	3,16	2,23 2,14	3,16	-	2,32	-	1,24	-	-	-	-	-	-	-	-	-
SWW6.0X240	3,16	2,23 2,14	3,16	2,23 2,14	3,16	2,23 2,14	3,16	2,23 2,14	3,16	2,23 2,14	3,16	-	2,32	-	1,24	-	-	-	-	-	-	-
SWW6.0X260	3,16	2,23 2,14	3,16	2,23 2,14	3,16	2,23 2,14	3,16	2,23 2,14	3,16	2,23 2,14	3,16	2,23 2,14	3,16	-	2,32	-	1,24	-	-	-	-	-
SWW6.0X280	3,16	2,23 2,14	3,16	2,23 2,14	3,16	2,23 2,14	3,16	2,23 2,14	3,16	2,23 2,14	3,16	2,23 2,14	3,16	2,23 2,14	3,16	-	2,32	-	1,24	-	-	-
SWW6.0X300	3,16	2,23 2,14	3,16	2,23 2,14	3,16	2,23 2,14	3,16	2,23 2,14	3,16	2,23 2,14	3,16	2,23 2,14	3,16	2,23 2,14	3,16	2,23 2,14	3,16	-	2,32	-	1,24	-

Table continues on next page.

CLT to CLT

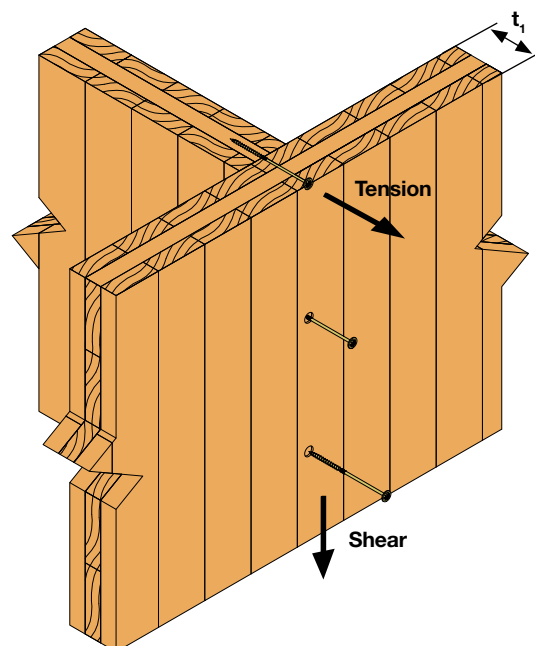
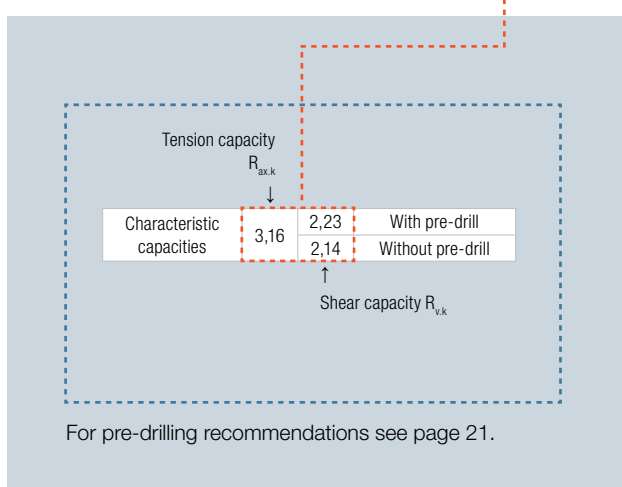

### 3.3.1 90° T-Connections Between CLT Panels

SWW - 90° T-Connection Between CLT Panels - Screws at 90°  
CLT to CLT  $\rho_k = 350 \text{ kg/m}^3$  (cont.)

Product Reference	Tension Capacity $R_{ax,k}$ Shear Capacity $R_{v,k}$ Depending on the Thickness of the Panel [kN] - Screws at 90°																							
	CLT Panel Thickness $t_f$ [mm]																							
	80	100	120	140	160	180	200	220	240	260	280	300	80	100	120	140	160	180	200	220	240	260	280	300
SWW8.0X90	0,84	-	-	-	-	-	-	-	-	-	-	-	-	-	-	-	-	-	-	-	-	-	-	-
SWW8.0X100	1,56	-	-	-	-	-	-	-	-	-	-	-	-	-	-	-	-	-	-	-	-	-	-	-
SWW8.0X120	2,92	-	1,56	-	-	-	-	-	-	-	-	-	-	-	-	-	-	-	-	-	-	-	-	-
SWW8.0X140	4,21	-	2,92	-	1,56	-	-	-	-	-	-	-	-	-	-	-	-	-	-	-	-	-	-	-
SWW8.0X160	5,08	3,51 3,41	4,21	-	2,92	-	1,56	-	-	-	-	-	-	-	-	-	-	-	-	-	-	-	-	-
SWW8.0X180	5,08	3,74 3,57	5,08	3,51 3,41	4,21	-	2,92	-	1,56	-	-	-	-	-	-	-	-	-	-	-	-	-	-	-
SWW8.0X200	5,08	3,74 3,57	5,08	3,74 3,57	5,08	3,51 3,41	4,21	-	2,92	-	1,56	-	-	-	-	-	-	-	-	-	-	-	-	-
SWW8.0X220	5,08	3,74 3,57	5,08	3,74 3,57	5,08	3,74 3,57	5,08	3,51 3,41	4,21	-	2,92	-	1,56	-	-	-	-	-	-	-	-	-	-	-
SWW8.0X240	5,08	3,74 3,57	5,08	3,74 3,57	5,08	3,74 3,57	5,08	3,74 3,57	5,08	3,51 3,41	4,21	-	2,92	-	1,56	-	-	-	-	-	-	-	-	-
SWW8.0X260	5,08	3,74 3,57	5,08	3,74 3,57	5,08	3,74 3,57	5,08	3,74 3,57	5,08	3,74 3,57	5,08	3,51 3,41	4,21	-	2,92	-	1,56	-	-	-	-	-	-	-
SWW8.0X280	5,08	3,74 3,57	5,08	3,74 3,57	5,08	3,74 3,57	5,08	3,74 3,57	5,08	3,74 3,57	5,08	3,74 3,57	5,08	3,51 3,41	4,21	-	2,92	-	1,56	-	-	-	-	-
SWW8.0X300	5,08	3,74 3,57	5,08	3,74 3,57	5,08	3,74 3,57	5,08	3,74 3,57	5,08	3,74 3,57	5,08	3,74 3,57	5,08	3,74 3,57	5,08	3,51 3,41	4,21	-	2,92	-	1,56	-	-	-
SWW8.0X320	5,08	3,74 3,57	5,08	3,74 3,57	5,08	3,74 3,57	5,08	3,74 3,57	5,08	3,74 3,57	5,08	3,74 3,57	5,08	3,74 3,57	5,08	3,74 3,57	5,08	3,51 3,41	4,21	-	2,92	-	1,56	-
SWW8.0X340	5,08	3,74 3,57	5,08	3,74 3,57	5,08	3,74 3,57	5,08	3,74 3,57	5,08	3,74 3,57	5,08	3,74 3,57	5,08	3,74 3,57	5,08	3,74 3,57	5,08	3,74 3,57	5,08	3,51 3,41	4,21	-	2,92	-
SWW8.0X360	5,08	3,74 3,57	5,08	3,74 3,57	5,08	3,74 3,57	5,08	3,74 3,57	5,08	3,74 3,57	5,08	3,74 3,57	5,08	3,74 3,57	5,08	3,74 3,57	5,08	3,74 3,57	5,08	3,74 3,57	5,08	3,51 3,41	4,21	-
SWW8.0X380	5,08	3,74 3,57	5,08	3,74 3,57	5,08	3,74 3,57	5,08	3,74 3,57	5,08	3,74 3,57	5,08	3,74 3,57	5,08	3,74 3,57	5,08	3,74 3,57	5,08	3,74 3,57	5,08	3,74 3,57	5,08	3,74 3,57	5,08	3,51 3,41
SWW8.0X400	5,08	3,74 3,57	5,08	3,74 3,57	5,08	3,74 3,57	5,08	3,74 3,57	5,08	3,74 3,57	5,08	3,74 3,57	5,08	3,74 3,57	5,08	3,74 3,57	5,08	3,74 3,57	5,08	3,74 3,57	5,08	3,74 3,57	5,08	3,51 3,41

Table continues on next page.

Tension capacity $R_{ax,k}$	
Characteristic capacities	5,08
	3,74
	3,57
	With pre-drill
	Without pre-drill
Shear capacity $R_{v,k}$	

For pre-drilling recommendations see page 21.

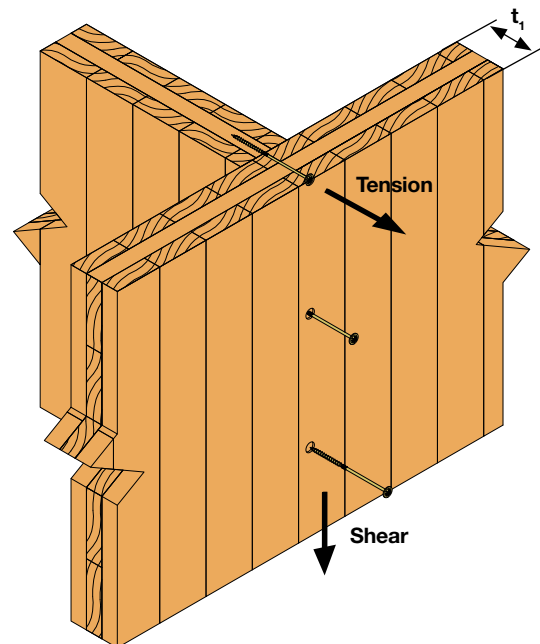

### 3.3.1 90° T-Connections Between CLT Panels

SWW - 90° T-Connection Between CLT Panels - Screws at 90°  
CLT to CLT  $\rho_k = 350 \text{ kg/m}^3$  (cont.)

Product Reference	Tension Capacity $R_{ax,k}$ Shear Capacity $R_{v,k}$ Depending on the Thickness of the Panel [kN] - Screws at 90°											
	CLT Panel Thickness $t_f$ [mm]											
	80	100	120	140	160	180	200	220	240	260	280	300
SWW10.0X100	1,87	-	-	-	-	-	-	-	-	-	-	-
SWW10.0X120	3,49	1,87	-	-	-	-	-	-	-	-	-	-
SWW10.0X140	5,03	3,49	1,87	-	-	-	-	-	-	-	-	-
SWW10.0X160	6,38	4,34 4,20	5,03	3,49	-	1,87	-	-	-	-	-	-
SWW10.0X180	6,38	4,73 4,57	6,38	4,34 4,20	5,03	3,49	-	1,87	-	-	-	-
SWW10.0X200	6,38	5,02 4,78	6,38	4,73 4,57	6,38	4,34 4,20	5,03	3,49	-	1,87	-	-
SWW10.0X220	6,38	5,02 4,78	6,38	5,02 4,78	6,38	4,73 4,57	6,38	4,34 4,20	5,03	3,49	-	1,87
SWW10.0X240	6,38	5,02 4,78	6,38	5,02 4,78	6,38	5,02 4,78	6,38	4,73 4,57	6,38	4,34 4,20	5,03	3,49
SWW10.0X260	6,38	5,02 4,78	6,38	5,02 4,78	6,38	5,02 4,78	6,38	4,73 4,57	6,38	4,34 4,20	5,03	3,49
SWW10.0X280	6,38	5,02 4,78	6,38	5,02 4,78	6,38	5,02 4,78	6,38	4,73 4,57	6,38	4,34 4,20	5,03	3,49
SWW10.0X300	6,38	5,02 4,78	6,38	5,02 4,78	6,38	5,02 4,78	6,38	4,73 4,57	6,38	4,34 4,20	5,03	3,49
SWW10.0X320	6,38	5,02 4,78	6,38	5,02 4,78	6,38	5,02 4,78	6,38	4,73 4,57	6,38	4,34 4,20	5,03	3,49
SWW10.0X340	6,38	5,02 4,78	6,38	5,02 4,78	6,38	5,02 4,78	6,38	4,73 4,57	6,38	4,34 4,20	5,03	3,49
SWW10.0X360	6,38	5,02 4,78	6,38	5,02 4,78	6,38	5,02 4,78	6,38	4,73 4,57	6,38	4,34 4,20	5,03	3,49
SWW10.0X380	6,38	5,02 4,78	6,38	5,02 4,78	6,38	5,02 4,78	6,38	4,73 4,57	6,38	4,34 4,20	5,03	3,49
SWW10.0X400	6,38	5,02 4,78	6,38	5,02 4,78	6,38	5,02 4,78	6,38	4,73 4,57	6,38	4,34 4,20	5,03	3,49

For dimensions and calculation parameters see p. 44.

CLT to CLT

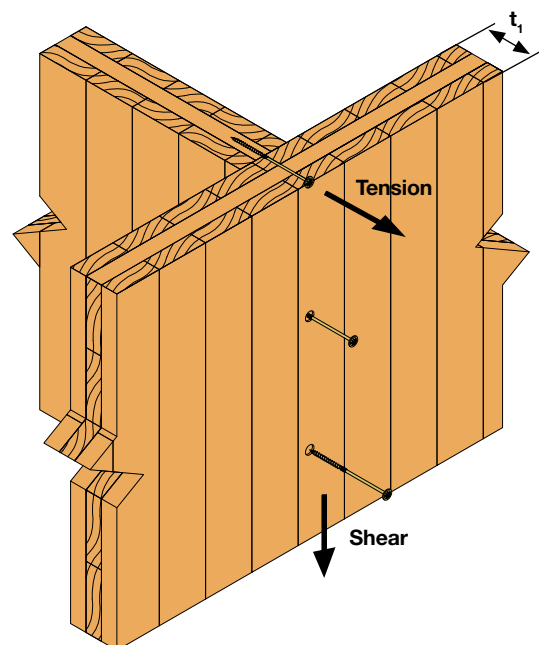
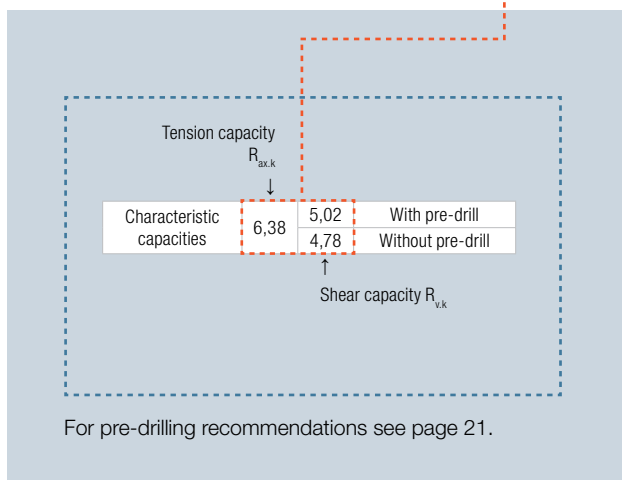

### 3.3.1 90° T-Connections Between CLT Panels

## Solid-Drive™ SWC Countersunk WOOD Screw for T-Connections Between CLT Panels

Yellow Zinc Plated  
C2 acc. to EN ISO 12944-2  
SC2 - 50 years acc. to EC5



ETA-21/0670

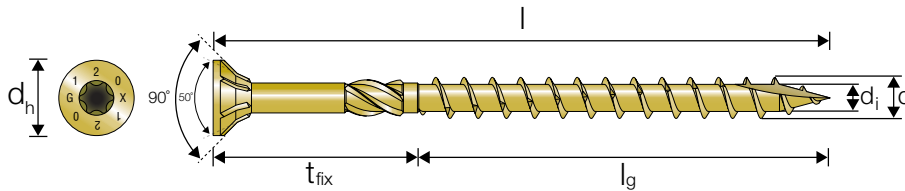

SWC - 90° T-Connection Between CLT Panels - Screws at 90°  
CLT to CLT  $\rho_k = 350 \text{ kg/m}^3$

Product Reference	Tension Capacity $R_{ax,k}$ Shear Capacity $R_{v,k}$ Depending on the Thickness of the Panel [kN] - Screws at 90°												
	CLT Panel Thickness $t_1$ [mm]												
	80	100	120	140	160	180	200	220	240	260	280	300	
SWC6.0X90	0,67	-	-	-	-	-	-	-	-	-	-	-	-
SWC6.0X100	1,24	-	-	-	-	-	-	-	-	-	-	-	-
SWC6.0X120	1,66	1,24	-	-	-	-	-	-	-	-	-	-	-
SWC6.0X140	1,66	1,66	1,24	-	-	-	-	-	-	-	-	-	-
SWC6.0X160	1,66	1,86 1,77	1,66	1,66	1,24	-	-	-	-	-	-	-	-
SWC6.0X180	1,66	1,86 1,77	1,66	1,86 1,77	1,66	1,24	-	-	-	-	-	-	-
SWC6.0X200	1,66	1,86 1,77	1,66	1,86 1,77	1,66	1,86 1,77	1,66	1,24	-	-	-	-	-
SWC6.0X220	1,66	1,86 1,77	1,66	1,86 1,77	1,66	1,86 1,77	1,66	1,86 1,77	1,66	1,24	-	-	-
SWC6.0X240	1,66	1,86 1,77	1,66	1,86 1,77	1,66	1,86 1,77	1,66	1,86 1,77	1,66	1,86 1,77	1,66	1,24	-
SWC6.0X260	1,66	1,86 1,77	1,66	1,86 1,77	1,66	1,86 1,77	1,66	1,86 1,77	1,66	1,86 1,77	1,66	1,86 1,77	1,66
SWC6.0X280	1,66	1,86 1,77	1,66	1,86 1,77	1,66	1,86 1,77	1,66	1,86 1,77	1,66	1,86 1,77	1,66	1,86 1,77	1,66
SWC6.0X300	1,66	1,86 1,77	1,66	1,86 1,77	1,66	1,86 1,77	1,66	1,86 1,77	1,66	1,86 1,77	1,66	1,86 1,77	1,66

Table continues on next page.

Tension capacity $R_{ax,k}$	
Characteristic capacities	1,66
	1,86
	1,77
	1,66
Shear capacity $R_{v,k}$	
	1,86
	1,77
	1,66

With pre-drill  
Without pre-drill

For pre-drilling recommendations see page 21.

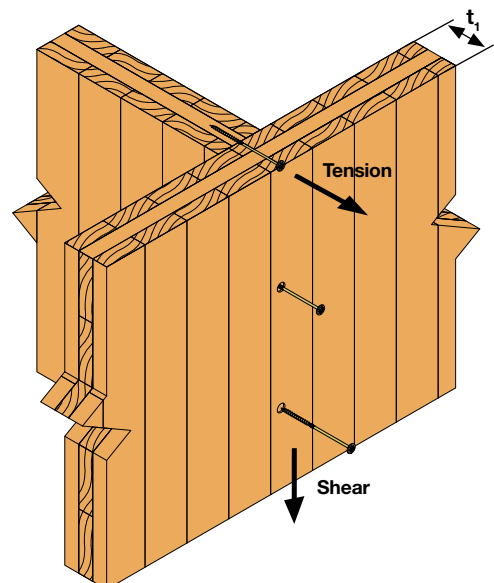

### 3.3.1 90° T-Connections Between CLT Panels

SWC - 90° T-Connection Between CLT Panels - Screws at 90°  
 CLT to CLT  $\rho_k = 350 \text{ kg/m}^3$  (cont.)

Product Reference	Tension Capacity $R_{ax,k}$ Shear Capacity $R_{v,k}$ Depending on the Thickness of the Panel [kN] - Screws at 90°																					
	CLT Panel Thickness $t_1$ [mm]																					
	80	100	120	140	160	180	200	220	240	260	280	300										
SWC8.0X90	0,84	-	-	-	-	-	-	-	-	-	-	-	-	-	-	-	-	-	-	-	-	-
SWC8.0X100	1,56	-	-	-	-	-	-	-	-	-	-	-	-	-	-	-	-	-	-	-	-	-
SWC8.0X120	2,66	-	1,56	-	-	-	-	-	-	-	-	-	-	-	-	-	-	-	-	-	-	-
SWC8.0X140	2,66	-	2,66	-	1,56	-	-	-	-	-	-	-	-	-	-	-	-	-	-	-	-	-
SWC8.0X160	2,66	2,91 2,80	2,66	-	2,66	-	1,56	-	-	-	-	-	-	-	-	-	-	-	-	-	-	-
SWC8.0X180	2,66	3,14 2,97	2,66	2,91 2,80	2,66	-	2,66	-	1,56	-	-	-	-	-	-	-	-	-	-	-	-	-
SWC8.0X200	2,66	3,14 2,97	2,66	3,14 2,97	2,66	2,91 2,80	2,66	-	2,66	-	1,56	-	-	-	-	-	-	-	-	-	-	-
SWC8.0X220	2,66	3,14 2,97	2,66	3,14 2,97	2,66	3,14 2,97	2,66	2,91 2,80	2,66	-	2,66	-	1,56	-	-	-	-	-	-	-	-	-
SWC8.0X240	2,66	3,14 2,97	2,66	3,14 2,97	2,66	3,14 2,97	2,66	3,14 2,97	2,66	2,91 2,80	2,66	-	2,66	-	1,56	-	-	-	-	-	-	-
SWC8.0X260	2,66	3,14 2,97	2,66	3,14 2,97	2,66	3,14 2,97	2,66	3,14 2,97	2,66	3,14 2,97	2,66	2,91 2,80	2,66	-	2,66	-	1,56	-	-	-	-	-
SWC8.0X280	2,66	3,14 2,97	2,66	3,14 2,97	2,66	3,14 2,97	2,66	3,14 2,97	2,66	3,14 2,97	2,66	3,14 2,97	2,66	2,91 2,80	2,66	-	2,66	-	1,56	-	-	-
SWC8.0X300	2,66	3,14 2,97	2,66	3,14 2,97	2,66	3,14 2,97	2,66	3,14 2,97	2,66	3,14 2,97	2,66	3,14 2,97	2,66	3,14 2,97	2,66	2,91 2,80	2,66	-	2,66	-	1,56	-
SWC8.0X320	2,66	3,14 2,97	2,66	3,14 2,97	2,66	3,14 2,97	2,66	3,14 2,97	2,66	3,14 2,97	2,66	3,14 2,97	2,66	3,14 2,97	2,66	3,14 2,97	2,66	2,91 2,80	2,66	-	2,66	-
SWC8.0X340	2,66	3,14 2,97	2,66	3,14 2,97	2,66	3,14 2,97	2,66	3,14 2,97	2,66	3,14 2,97	2,66	3,14 2,97	2,66	3,14 2,97	2,66	3,14 2,97	2,66	3,14 2,97	2,66	2,91 2,80	2,66	-
SWC8.0X360	2,66	3,14 2,97	2,66	3,14 2,97	2,66	3,14 2,97	2,66	3,14 2,97	2,66	3,14 2,97	2,66	3,14 2,97	2,66	3,14 2,97	2,66	3,14 2,97	2,66	3,14 2,97	2,66	3,14 2,97	2,66	2,91 2,80
SWC8.0X380	2,66	3,14 2,97	2,66	3,14 2,97	2,66	3,14 2,97	2,66	3,14 2,97	2,66	3,14 2,97	2,66	3,14 2,97	2,66	3,14 2,97	2,66	3,14 2,97	2,66	3,14 2,97	2,66	3,14 2,97	2,66	2,91 2,80
SWC8.0X400	2,66	3,14 2,97	2,66	3,14 2,97	2,66	3,14 2,97	2,66	3,14 2,97	2,66	3,14 2,97	2,66	3,14 2,97	2,66	3,14 2,97	2,66	3,14 2,97	2,66	3,14 2,97	2,66	3,14 2,97	2,66	2,91 2,80

Table continues on next page.

CLT to CLT

C-F-EU-TG-2023-2 (2<sup>nd</sup> Edition) © 2023 SIMPSON STRONG-TIE COMPANY INC.

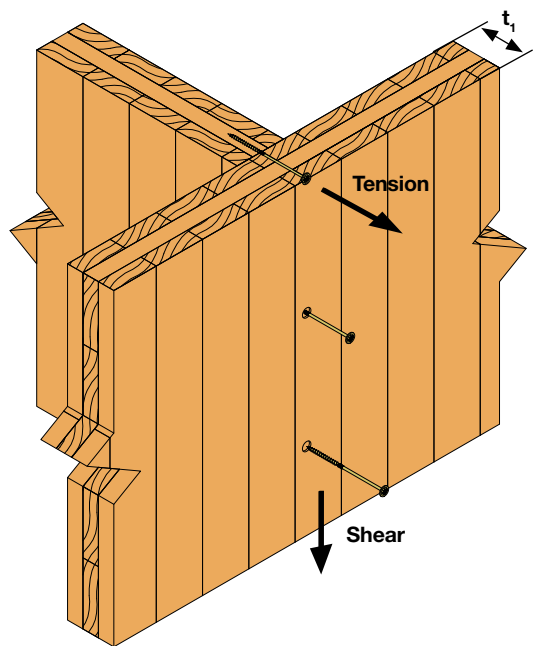
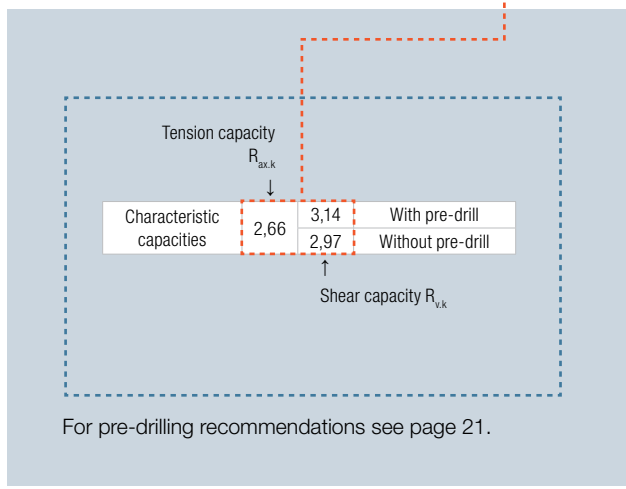

### 3.3.1 90° T-Connections Between CLT Panels

SWC - 90° T-Connection Between CLT Panels - Screws at 90°  
CLT to CLT  $\rho_k = 350 \text{ kg/m}^3$  (cont.)

Product Reference	Tension Capacity $R_{ax,k}$ Shear Capacity $R_{v,k}$ Depending on the Thickness of the Panel [kN] - Screws at 90°																						
	CLT Panel Thickness $t_f$ [mm]																						
	80	100	120	140	160	180	200	220	240	260	280	300	80	100	120	140	160	180	200	220	240	260	280
SWC10.0X100	1,87	-	-	-	-	-	-	-	-	-	-	-	-	-	-	-	-	-	-	-	-	-	-
SWC10.0X120	3,49	-	1,87	-	-	-	-	-	-	-	-	-	-	-	-	-	-	-	-	-	-	-	-
SWC10.0X140	3,55	-	3,49	-	1,87	-	-	-	-	-	-	-	-	-	-	-	-	-	-	-	-	-	-
SWC10.0X160	3,55	3,63 3,49	3,55	-	3,49	-	1,87	-	-	-	-	-	-	-	-	-	-	-	-	-	-	-	-
SWC10.0X180	3,55	4,02 3,87	3,55	3,63 3,49	3,55	-	3,49	-	1,87	-	-	-	-	-	-	-	-	-	-	-	-	-	-
SWC10.0X200	3,55	4,31 4,07	3,55	4,02 3,87	3,55	3,63 3,49	3,55	-	3,49	-	1,87	-	-	-	-	-	-	-	-	-	-	-	-
SWC10.0X220	3,55	4,31 4,07	3,55	4,31 4,07	3,55	4,02 3,87	3,55	3,63 3,49	3,55	-	3,49	-	1,87	-	-	-	-	-	-	-	-	-	-
SWC10.0X240	3,55	4,31 4,07	3,55	4,31 4,07	3,55	4,31 4,07	3,55	4,02 3,87	3,55	3,63 3,49	3,55	-	3,49	-	1,87	-	-	-	-	-	-	-	-
SWC10.0X260	3,55	4,31 4,07	3,55	4,31 4,07	3,55	4,31 4,07	3,55	4,31 4,07	3,55	4,02 3,87	3,55	3,63 3,49	3,55	-	3,49	-	1,87	-	-	-	-	-	-
SWC10.0X280	3,55	4,31 4,07	3,55	4,31 4,07	3,55	4,31 4,07	3,55	4,31 4,07	3,55	4,31 4,07	3,55	4,02 3,87	3,55	3,63 3,49	3,55	-	3,49	-	1,87	-	-	-	-
SWC10.0X300	3,55	4,31 4,07	3,55	4,31 4,07	3,55	4,31 4,07	3,55	4,31 4,07	3,55	4,31 4,07	3,55	4,31 4,07	3,55	4,02 3,87	3,55	3,63 3,49	3,55	-	3,49	-	1,87	-	-
SWC10.0X320	3,55	4,31 4,07	3,55	4,31 4,07	3,55	4,31 4,07	3,55	4,31 4,07	3,55	4,31 4,07	3,55	4,31 4,07	3,55	4,31 4,07	3,55	4,02 3,87	3,55	3,63 3,49	3,55	-	3,49	-	1,87
SWC10.0X340	3,55	4,31 4,07	3,55	4,31 4,07	3,55	4,31 4,07	3,55	4,31 4,07	3,55	4,31 4,07	3,55	4,31 4,07	3,55	4,31 4,07	3,55	4,31 4,07	3,55	4,02 3,87	3,55	3,63 3,49	3,55	-	3,49
SWC10.0X360	3,55	4,31 4,07	3,55	4,31 4,07	3,55	4,31 4,07	3,55	4,31 4,07	3,55	4,31 4,07	3,55	4,31 4,07	3,55	4,31 4,07	3,55	4,31 4,07	3,55	4,31 4,07	3,55	4,02 3,87	3,55	3,63 3,49	3,55
SWC10.0X380	3,55	4,31 4,07	3,55	4,31 4,07	3,55	4,31 4,07	3,55	4,31 4,07	3,55	4,31 4,07	3,55	4,31 4,07	3,55	4,31 4,07	3,55	4,31 4,07	3,55	4,31 4,07	3,55	4,31 4,07	3,55	4,02 3,87	3,55
SWC10.0X400	3,55	4,31 4,07	3,55	4,31 4,07	3,55	4,31 4,07	3,55	4,31 4,07	3,55	4,31 4,07	3,55	4,31 4,07	3,55	4,31 4,07	3,55	4,31 4,07	3,55	4,31 4,07	3,55	4,31 4,07	3,55	4,31 4,07	3,55

For dimensions and calculation parameters see p. 48.

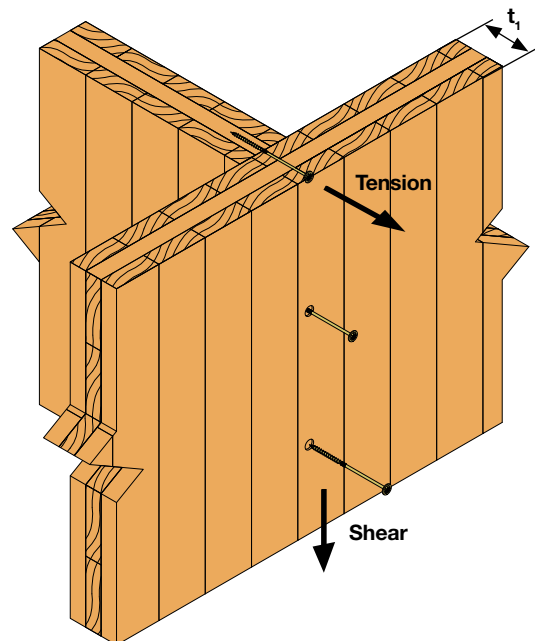
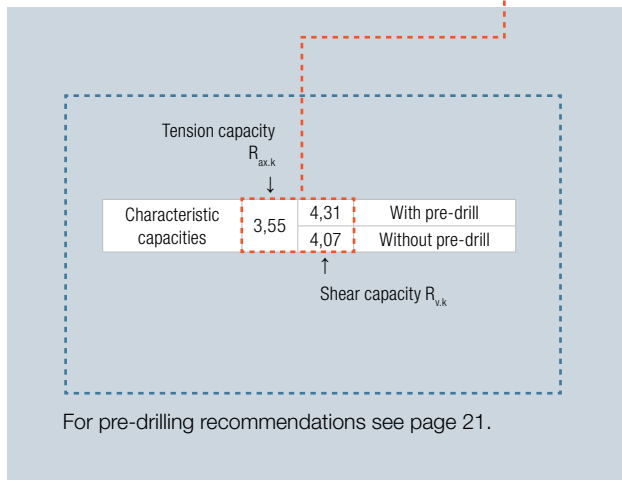



### 3.3.1 90° T-Connections Between CLT Panels

#### Minimum Distances for Screws 90° Angles Between CLT Panels

##### TTUFS

Dimensions	$a_1$	$a_{3,c}$	$a_{4,c}$
6.0xℓ	60	36	18

##### SWW

Dimensions	$a_1$	$a_{3,c}$	$a_{4,c}$
6.0xℓ	60	36	18
8.0xℓ	80	48	24
10.0xℓ	100	60	30

##### SWC

Dimensions	$a_1$	$a_{3,c}$	$a_{4,c}$
6.0xℓ	60	36	18
8.0xℓ	80	48	24
10.0xℓ	100	60	30

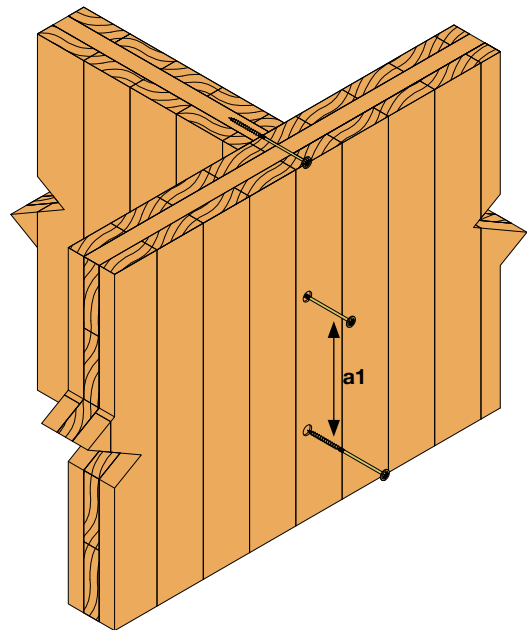
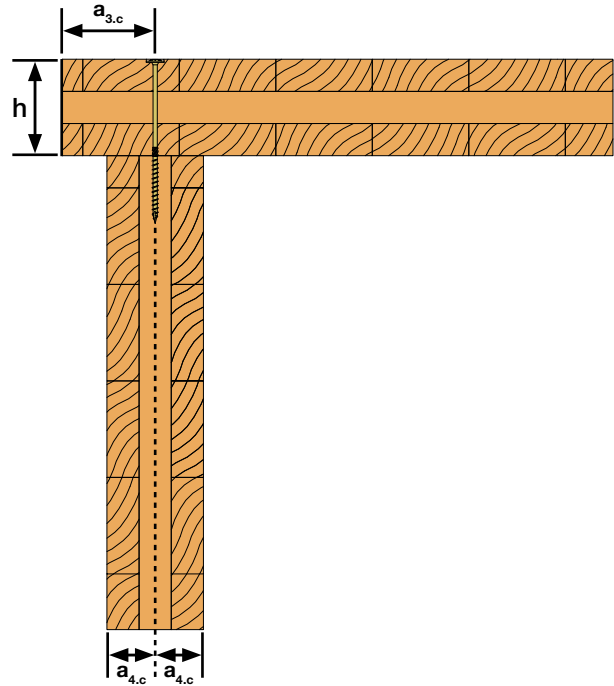

### 3.3.1 90° T-Connections Between CLT Panels

## Solid-Drive™ SWD Double Threaded WOOD Screw for T-Connections Between CLT Panels

Protec® +  
C3 acc. to EN ISO 12944-2  
SC2 - 50 years acc. to EC5

UK  
CA



ETA-21/0670

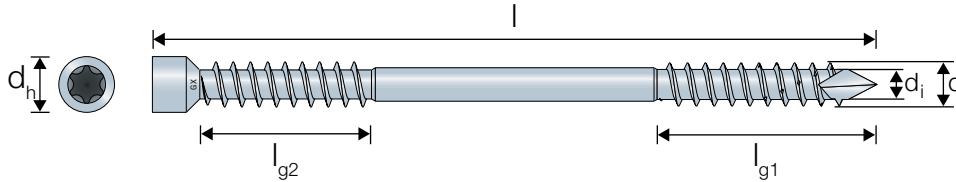

SWD - 90° T-Connection Between CLT Panels -  
45° Cross Pairs, CLT to CLT  $\rho_k = 350 \text{ kg/m}^3$

Product Reference	Minimum thickness $h_{\min}$	Shear capacity $R_{v,k} = \min(R_{w,k,\text{pair}}; R_{\text{buck},k,\text{pair}})$ [kN]	
		$R_{w,k,\text{pair}}$	$R_{\text{buck},k,\text{pair}}$
SWD6.5X65	52	0,0	$0 + 5.51 / k_{\text{mod}}$
SWD6.5X90	52	3,9	$1.96 + 5.51 / k_{\text{mod}}$
SWD6.5X130	56	3,9	$1.96 + 5.51 / k_{\text{mod}}$
SWD6.5X160	67	6,9	$3.43 + 5.51 / k_{\text{mod}}$
SWD6.5X190	78	8,6	$4.31 + 5.51 / k_{\text{mod}}$
SWD6.5X220	88	10,4	$5.19 + 5.51 / k_{\text{mod}}$
SWD8.0X90	64	4,4	$2.17 + 10.22 / k_{\text{mod}}$
SWD8.0X130	64	4,4	$2.17 + 10.22 / k_{\text{mod}}$
SWD8.0X160	67	7,8	$3.9 + 10.22 / k_{\text{mod}}$
SWD8.0X190	78	9,9	$4.94 + 10.22 / k_{\text{mod}}$
SWD8.0X220	88	12,0	$5.98 + 10.22 / k_{\text{mod}}$
SWD8.0X245	97	13,7	$6.84 + 10.22 / k_{\text{mod}}$
SWD8.0X275	108	13,7	$6.84 + 10.22 / k_{\text{mod}}$
SWD8.0X300	117	17,5	$8.74 + 10.22 / k_{\text{mod}}$
SWD8.0X330	127	17,5	$8.74 + 10.22 / k_{\text{mod}}$

For dimensions and calculation parameters see p. 50.

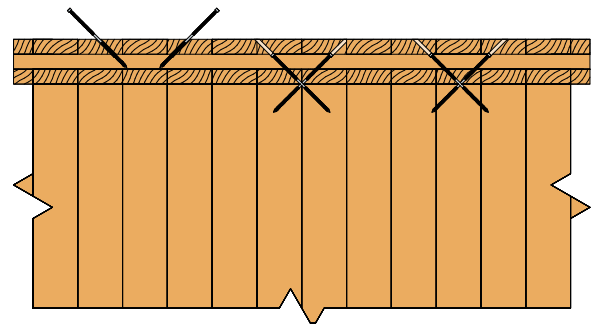
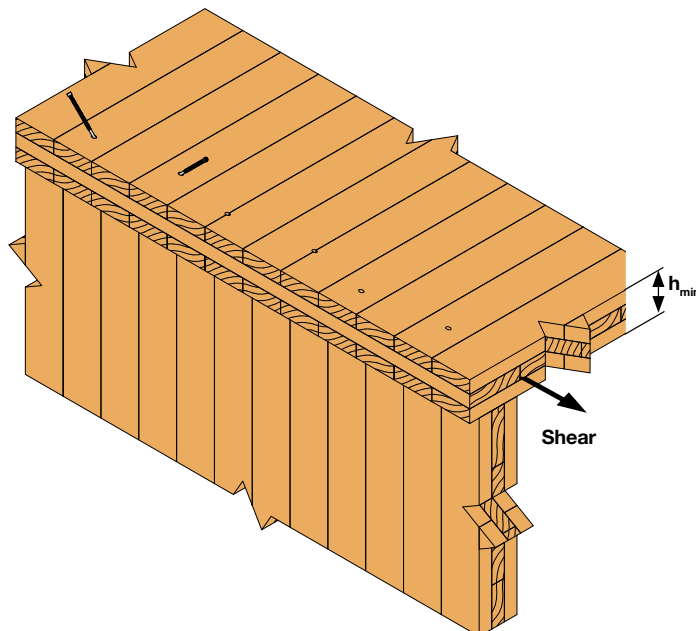

### 3.3.1 90° T-Connections Between CLT Panels

## **Solid-Drive™** ESCRFTZ Full Threaded **WOOD** Screw for T-Connections Between CLT Panels

Yellow Zinc Plated  
C2 acc. to EN ISO 12944-2  
SC2 - 50 years acc. to EC5

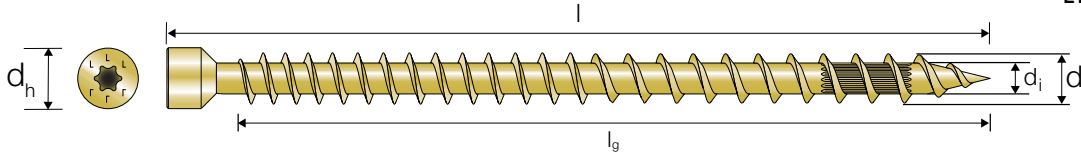

ESCRFTZ - 90° Angles Between CLT Panels -  
45° Cross Pairs, CLT to CLT  $\rho_k = 350 \text{ kg/m}^3$

Product Reference	Minimum thickness $h_{min}$	Shear capacity $R_{v,k} = \min(R_{w,k,pair}; R_{buck,k,pair})$ [kN]	
		$R_{w,k,pair}$	$R_{buck,k,pair}$
ESCRFTZ8.0X120	64	6,2	$3.11 + 9.23 / k_{mod}$
ESCRFTZ8.0X140	64	7,6	$3.8 + 9.23 / k_{mod}$
ESCRFTZ8.0X160	67	9,0	$4.49 + 9.23 / k_{mod}$
ESCRFTZ8.0X180	74	10,4	$5.18 + 9.23 / k_{mod}$
ESCRFTZ8.0X200	81	11,8	$5.87 + 9.23 / k_{mod}$
ESCRFTZ8.0X220	88	13,1	$6.56 + 9.23 / k_{mod}$
ESCRFTZ8.0X240	95	14,5	$7.25 + 9.23 / k_{mod}$
ESCRFTZ8.0X260	102	15,9	$7.95 + 9.23 / k_{mod}$
ESCRFTZ8.0X280	109	17,3	$8.64 + 9.23 / k_{mod}$
ESCRFTZ8.0X300	117	18,7	$9.33 + 9.23 / k_{mod}$
ESCRFTZ8.0X350	134	22,1	$11.06 + 9.23 / k_{mod}$
ESCRFTZ8.0X400	152	25,6	$12.79 + 9.23 / k_{mod}$

For dimensions and calculation parameters see p. 58.

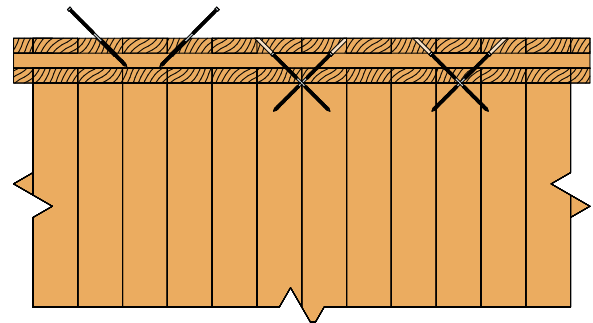
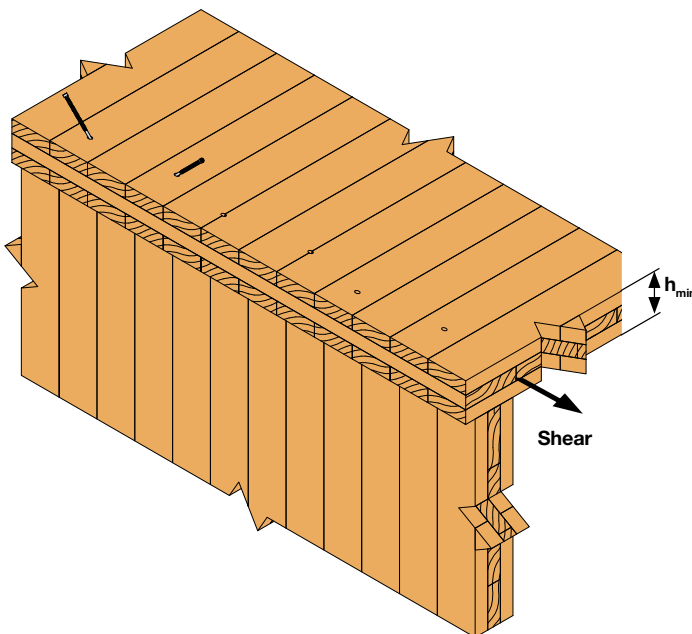

### 3.3.1 90° T-Connections Between CLT Panels

## **Solid-Drive™** ESCRFT Full Threaded **WOOD** Screw for T-Connections Between CLT Panels

Yellow Zinc Plated  
C2 acc. to EN ISO 12944-2  
SC2 - 50 years acc. to EC5

UK  
CA



ETA-13/0796

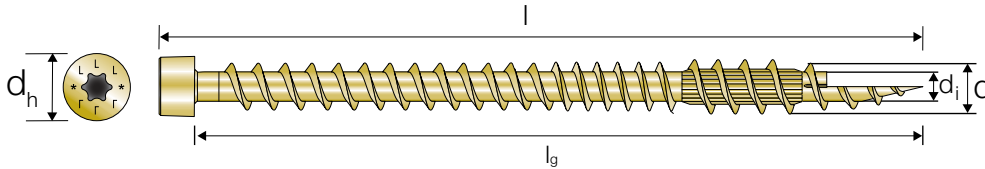

ESCRFT - 90° Angles Between CLT Panels -  
45° Cross Pairs, CLT to CLT  $\rho_k = 350 \text{ kg/m}^3$

Product Reference	Minimum thickness $h_{min}$	Shear capacity $R_{v,k} = \min(R_{w,k,pair}; R_{buck,k,pair})$ [kN]	
		$R_{w,k,pair}$	$R_{buck,k,pair}$
ESCRFT10.0x450	170	31,2	$15.58 + 12.95 / k_{mod}$
ESCRFT10.0x500	187	35,3	$17.64 + 12.95 / k_{mod}$
ESCRFT10.0x600	223	43,5	$21.77 + 12.95 / k_{mod}$
ESCRFT10.0x800	293	52,8	$26.39 + 12.95 / k_{mod}$
ESCRFT10.0x1000	364	52,8	$26.39 + 12.95 / k_{mod}$

For dimensions and calculation parameters see p. 60.

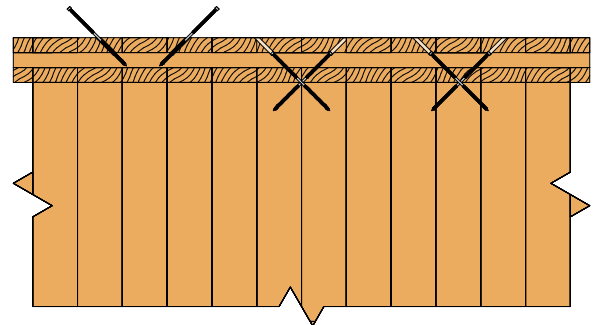
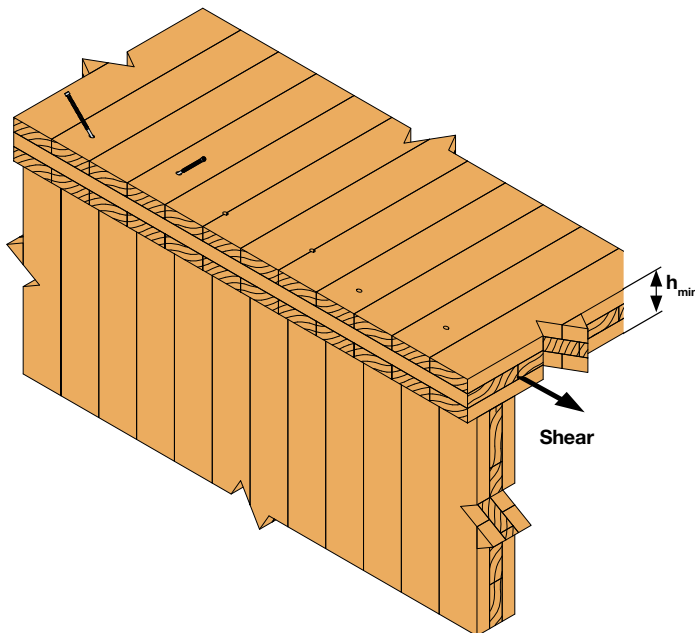

CLT to CLT

### 3.3.1 90° T-Connections Between CLT Panels

Minimum Distances for Screws  
90° Angles Between CLT Panels - 45° Cross Pairs

#### SWD

Dimensions	$a_1$	$a_{1,red}$	$a_{2,red}$	$a_{3,c}$	$a_{4,c}$
6.5xℓ	65	10	10	39	20
8.0xℓ	80	12	12	48	24

#### ESCRFTZ/ESCRFT

Dimensions	$a_1$	$a_{1,red}$	$a_{2,red}$	$a_{3,c}$	$a_{4,c}$
8.0xℓ	80	12	12	48	24
10.0xℓ	100	15	15	60	30

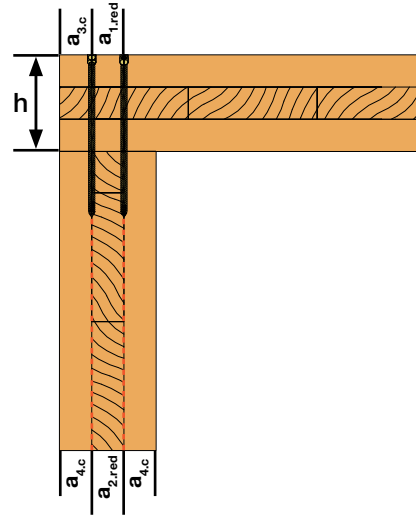

See General Introduction chapter pages 27-28.

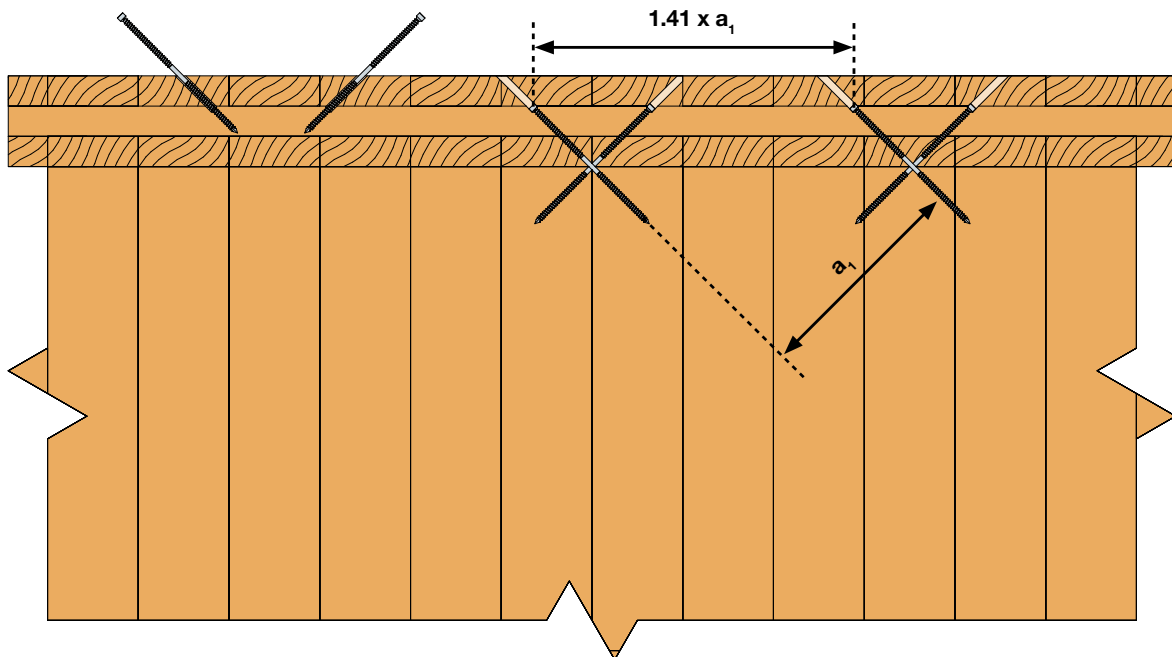

### 3.3.2 Solid Timber Wall-Plate to CLT Panel

## Solid-Drive™ TTUFS Countersunk WOOD Screw for Solid-Timber Wall-Plate to CLT Panel

Electro Galvanised  
C1 acc. to EN ISO 12944-2  
SC2 - 50 years acc. to EC5

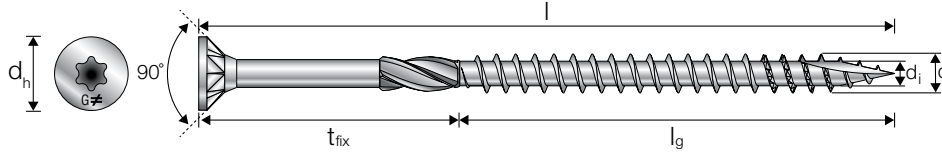

TTUFS - Solid-Timber Wall-Plate to CLT Panel - Screws at 90°  
Solid Timber C24 to CLT  $\rho_k = 350 \text{ kg/m}^3$

Product Reference	Thread Length $L_g$ [mm]	Max Advised Wood Thickness $t_1$ [mm]	Tension Capacity $R_{ax,k}$ Shear Capacity $R_{v,k}$ Depending on the Thickness of the Wall Plate [kN] - Screws at 90°																																		
			Wall Plate Thickness $t_1$ [mm]																																		
			36	45	50	60	63	70	75	80	100	36	45	50	60	63	70	75	80	100																	
TTUFS5.0X80	40	40	1,54	1,94	1,54	1,94	-	-	-	-	-	-	-	-	-	-	-	-	-	1,54	1,64	1,54	1,64	-	-	-	-	-	-	-	-	-	-	-	-	-	-
TTUFS5.0X90	45	45	1,54	1,94	1,54	1,94	1,54	1,94	-	-	-	-	-	-	-	-	-	-	-	1,54	1,64	1,54	1,64	1,54	1,94	-	-	-	-	-	-	-	-	-	-	-	-
TTUFS5.0X100	60	40	1,54	1,94	1,54	1,94	-	-	-	-	-	-	-	-	-	-	-	-	-	1,54	1,64	1,54	1,64	-	-	-	-	-	-	-	-	-	-	-	-	-	-
TTUFS5.0X120	60	60	1,54	1,94	1,54	1,94	1,54	1,94	1,54	1,94	1,54	1,94	-	-	-	-	-	-	-	1,54	1,64	1,54	1,64	1,54	1,94	1,54	1,94	-	-	-	-	-	-	-	-	-	-
TTUFS6.0X80	40	40	2,23	2,58	2,23	2,58	-	-	-	-	-	-	-	-	-	-	-	-	-	2,23	2,09	2,23	2,06	-	-	-	-	-	-	-	-	-	-	-	-	-	-
TTUFS6.0X90	45	45	2,23	2,58	2,23	2,58	2,23	2,58	-	-	-	-	-	-	-	-	-	-	-	2,23	2,09	2,23	2,15	2,23	2,58	-	-	-	-	-	-	-	-	-	-	-	-
TTUFS6.0X100	60	40	2,23	2,58	2,23	2,58	-	-	-	-	-	-	-	-	-	-	-	-	-	2,23	2,09	2,23	2,15	-	-	-	-	-	-	-	-	-	-	-	-	-	-
TTUFS6.0X120	70	50	2,23	2,58	2,23	2,58	2,23	2,58	-	-	-	-	-	-	-	-	-	-	-	2,23	2,09	2,23	2,15	2,23	2,58	-	-	-	-	-	-	-	-	-	-	-	-
TTUFS6.0X140	70	70	2,23	2,58	2,23	2,58	2,23	2,58	2,23	2,58	2,23	2,58	2,23	2,58	2,23	2,58	2,23	2,58	-	2,23	2,09	2,23	2,15	2,23	2,58	2,23	2,58	2,23	2,58	2,23	2,58	2,23	2,58	-	-	-	
TTUFS6.0X160	70	90	2,23	2,58	2,23	2,58	2,23	2,58	2,23	2,58	2,23	2,58	2,23	2,58	2,23	2,58	2,23	2,58	2,23	2,23	2,09	2,23	2,15	2,23	2,58	2,23	2,58	2,23	2,58	2,23	2,58	2,23	2,58	-	-	-	
TTUFS6.0X180	70	110	2,23	2,58	2,23	2,58	2,23	2,58	2,23	2,58	2,23	2,58	2,23	2,58	2,23	2,58	2,23	2,58	2,23	2,23	2,09	2,23	2,15	2,23	2,58	2,23	2,58	2,23	2,58	2,23	2,58	2,23	2,58	2,23	2,58	-	-

For dimensions and calculation parameters see p. 40.

Tension capacity $R_{ax,k}$	2,23	2,58	With pre-drill
Characteristic capacities	2,23	2,15	Without pre-drill
Shear capacity $R_{v,k}$	2,23	2,15	

For pre-drilling recommendations see page 21.

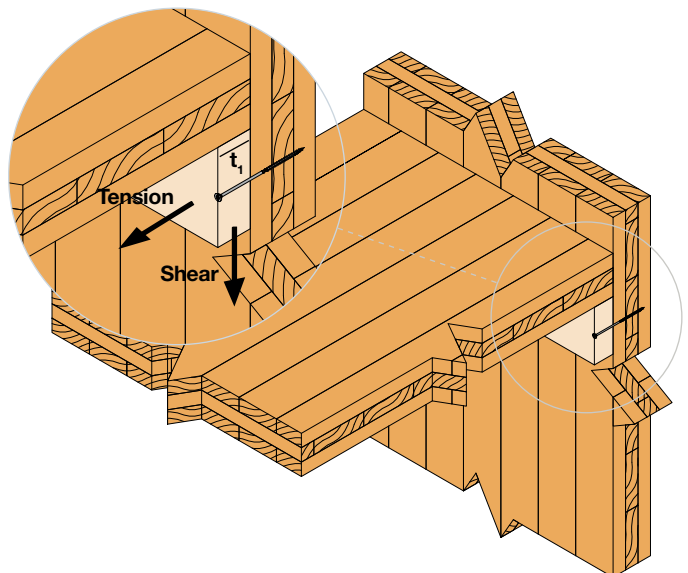

### 3.3.2 Solid Timber Wall-Plate to CLT Panel

## Solid-Drive™ SWW Washer-Head WOOD Screw for Solid-Timber Wall-Plate to CLT Panel

Yellow Zinc Plated  
C2 acc. to EN ISO 12944-2  
SC2 - 50 years acc. to EC5

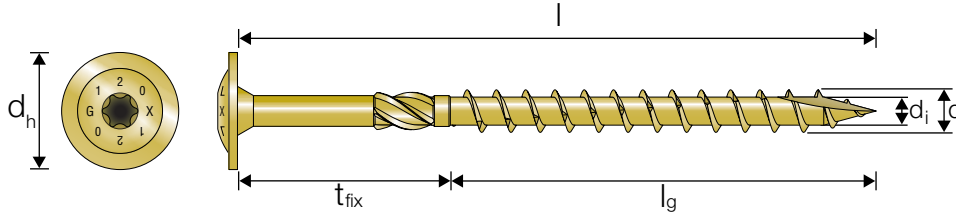

SWW - Solid-Timber Wall-Plate to CLT Panel - Screws at 90°  
Solid Timber C24 to CLT  $\rho_k = 350 \text{ kg/m}^3$

Product Reference	Thread Length $L_g$ [mm]	Max Advised Wood Thickness $t_1$ [mm]	Tension Capacity $R_{ax,k}$ Shear Capacity $R_{v,k}$ Depending on the Thickness of the Wall Plate [kN] - Screws at 90°																	
			Wall Plate Thickness $t_1$ [mm]																	
			36	45	50	60	63	70	75	80	100	36	45	50	60	63	70	75	80	100
SWW6.0X100	50	50	3,16	2,91 2,35	3,16	2,91 2,46	3,16	2,91 2,46	-	-	-	-	-	-	-	-	-	-	-	
SWW6.0X120	50	70	3,16	2,91 2,35	3,16	2,91 2,46	3,16	2,91 2,46	3,16	2,91 2,46	3,16	2,91 2,46	3,16	2,91 2,46	3,16	2,91 2,46	-	-	-	
SWW6.0X140	70	70	3,16	2,91 2,35	3,16	2,91 2,46	3,16	2,91 2,46	3,16	2,91 2,46	3,16	2,91 2,46	3,16	2,91 2,46	3,16	2,91 2,46	-	-	-	
SWW6.0X16.00	70	90	3,16	2,91 2,35	3,16	2,91 2,46	3,16	2,91 2,46	3,16	2,91 2,46	3,16	2,91 2,46	3,16	2,91 2,46	3,16	2,91 2,46	3,16	2,91 2,46	-	
SWW6.0X180	70	110	3,16	2,91 2,35	3,16	2,91 2,46	3,16	2,91 2,46	3,16	2,91 2,46	3,16	2,91 2,46	3,16	2,91 2,46	3,16	2,91 2,46	3,16	2,91 2,46	3,16	2,91 2,46
SWW6.0X200	70	130	3,16	2,91 2,35	3,16	2,91 2,46	3,16	2,91 2,46	3,16	2,91 2,46	3,16	2,91 2,46	3,16	2,91 2,46	3,16	2,91 2,46	3,16	2,91 2,46	3,16	2,91 2,46
SWW6.0X220	70	150	3,16	2,91 2,35	3,16	2,91 2,46	3,16	2,91 2,46	3,16	2,91 2,46	3,16	2,91 2,46	3,16	2,91 2,46	3,16	2,91 2,46	3,16	2,91 2,46	3,16	2,91 2,46
SWW6.0X240	70	170	3,16	2,91 2,35	3,16	2,91 2,46	3,16	2,91 2,46	3,16	2,91 2,46	3,16	2,91 2,46	3,16	2,91 2,46	3,16	2,91 2,46	3,16	2,91 2,46	3,16	2,91 2,46
SWW6.0X26.00	70	190	3,16	2,91 2,35	3,16	2,91 2,46	3,16	2,91 2,46	3,16	2,91 2,46	3,16	2,91 2,46	3,16	2,91 2,46	3,16	2,91 2,46	3,16	2,91 2,46	3,16	2,91 2,46
SWW6.0X280	70	210	3,16	2,91 2,35	3,16	2,91 2,46	3,16	2,91 2,46	3,16	2,91 2,46	3,16	2,91 2,46	3,16	2,91 2,46	3,16	2,91 2,46	3,16	2,91 2,46	3,16	2,91 2,46
SWW6.0X300	70	230	3,16	2,91 2,35	3,16	2,91 2,46	3,16	2,91 2,46	3,16	2,91 2,46	3,16	2,91 2,46	3,16	2,91 2,46	3,16	2,91 2,46	3,16	2,91 2,46	3,16	2,91 2,46

Table continues on next page.

CLT to CLT

C-F-EU-TG-2023-2 (2<sup>nd</sup> Edition) © 2023 SIMPSON STRONG-TIE COMPANY INC.

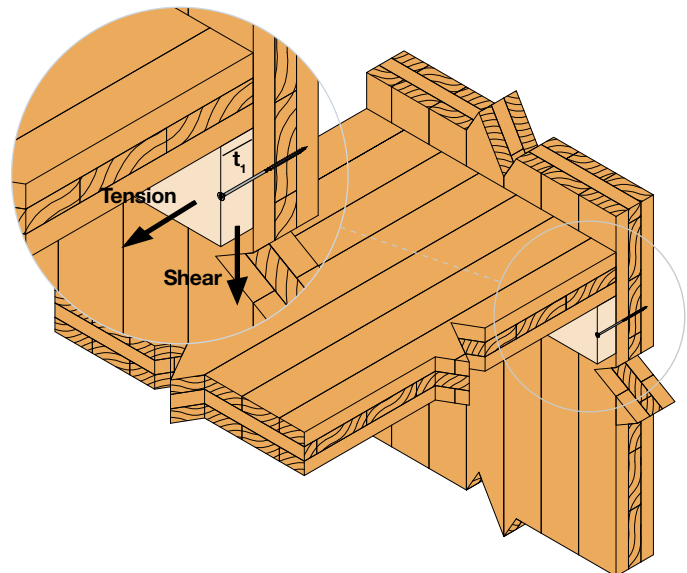
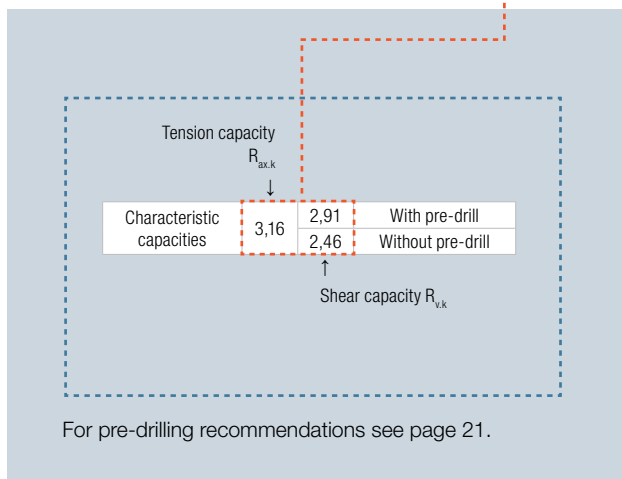



### 3.3.2 Solid Timber Wall-Plate to CLT Panel

SWW - Solid-Timber Wall-Plate to CLT Panel - Screws at 90°  
 Solid Timber C24 to CLT  $\rho_k = 350 \text{ kg/m}^3$  (cont.)

Product Reference	Thread Length $L_s$ [mm]	Max Advised Wood Thickness $t_1$ [mm]	Tension Capacity $R_{ax,k}$ Shear Capacity $R_{vk}$ Depending on the Thickness of the Wall Plate [kN] - Screws at 90°																	
			Wall Plate Thickness $t_1$ [mm]																	
			36		45		50		60		63		70		75		80		100	
SWW8.0X100	50	50	5,04	4,63 3,49	5,04	5,06 3,76	5,04	5,06 3,81	-	-	-	-	-	-	-	-	-	-	-	
SWW8.0X120	80	40	5,08	4,64 3,50	5,08	5,07 3,77	-	-	-	-	-	-	-	-	-	-	-	-	-	
SWW8.0X140	80	60	5,08	4,64 3,50	5,08	5,07 3,77	5,08	5,07 3,94	5,08	5,07 4,17	5,08	5,07 4,17	-	-	-	-	-	-	-	
SWW8.0X160	80	80	5,08	4,64 3,50	5,08	5,07 3,77	5,08	5,07 3,94	5,08	5,07 4,17	5,08	5,07 4,17	5,08	5,07 4,17	5,08	5,07 4,17	5,08	5,07 4,17	-	-
SWW8.0X180	80	100	5,08	4,64 3,50	5,08	5,07 3,77	5,08	5,07 3,94	5,08	5,07 4,17	5,08	5,07 4,17	5,08	5,07 4,17	5,08	5,07 4,17	5,08	5,07 4,17	5,08	5,07 4,17
SWW8.0X200	80	120	5,08	4,64 3,50	5,08	5,07 3,77	5,08	5,07 3,94	5,08	5,07 4,17	5,08	5,07 4,17	5,08	5,07 4,17	5,08	5,07 4,17	5,08	5,07 4,17	5,08	5,07 4,17
SWW8.0X220	80	140	5,08	4,64 3,50	5,08	5,07 3,77	5,08	5,07 3,94	5,08	5,07 4,17	5,08	5,07 4,17	5,08	5,07 4,17	5,08	5,07 4,17	5,08	5,07 4,17	5,08	5,07 4,17
SWW8.0X240	80	160	5,08	4,64 3,50	5,08	5,07 3,77	5,08	5,07 3,94	5,08	5,07 4,17	5,08	5,07 4,17	5,08	5,07 4,17	5,08	5,07 4,17	5,08	5,07 4,17	5,08	5,07 4,17
SWW8.0X260	80	180	5,08	4,64 3,50	5,08	5,07 3,77	5,08	5,07 3,94	5,08	5,07 4,17	5,08	5,07 4,17	5,08	5,07 4,17	5,08	5,07 4,17	5,08	5,07 4,17	5,08	5,07 4,17
SWW8.0X280	80	200	5,08	4,64 3,50	5,08	5,07 3,77	5,08	5,07 3,94	5,08	5,07 4,17	5,08	5,07 4,17	5,08	5,07 4,17	5,08	5,07 4,17	5,08	5,07 4,17	5,08	5,07 4,17
SWW8.0X300	80	220	5,08	4,64 3,50	5,08	5,07 3,77	5,08	5,07 3,94	5,08	5,07 4,17	5,08	5,07 4,17	5,08	5,07 4,17	5,08	5,07 4,17	5,08	5,07 4,17	5,08	5,07 4,17
SWW8.0X320	80	240	5,08	4,64 3,50	5,08	5,07 3,77	5,08	5,07 3,94	5,08	5,07 4,17	5,08	5,07 4,17	5,08	5,07 4,17	5,08	5,07 4,17	5,08	5,07 4,17	5,08	5,07 4,17
SWW8.0X340	80	260	5,08	4,64 3,50	5,08	5,07 3,77	5,08	5,07 3,94	5,08	5,07 4,17	5,08	5,07 4,17	5,08	5,07 4,17	5,08	5,07 4,17	5,08	5,07 4,17	5,08	5,07 4,17
SWW8.0X360	80	280	5,08	4,64 3,50	5,08	5,07 3,77	5,08	5,07 3,94	5,08	5,07 4,17	5,08	5,07 4,17	5,08	5,07 4,17	5,08	5,07 4,17	5,08	5,07 4,17	5,08	5,07 4,17
SWW8.0X380	80	300	5,08	4,64 3,50	5,08	5,07 3,77	5,08	5,07 3,94	5,08	5,07 4,17	5,08	5,07 4,17	5,08	5,07 4,17	5,08	5,07 4,17	5,08	5,07 4,17	5,08	5,07 4,17
SWW8.0X400	80	320	5,08	4,64 3,50	5,08	5,07 3,77	5,08	5,07 3,94	5,08	5,07 4,17	5,08	5,07 4,17	5,08	5,07 4,17	5,08	5,07 4,17	5,08	5,07 4,17	5,08	5,07 4,17
SWW10.0X100	50	50	-	-	6,10	6,56 4,53	6,10	6,87 4,50	-	-	-	-	-	-	-	-	-	-	-	-
SWW10.0X120	50	70	-	-	6,10	6,56 4,72	6,10	6,92 4,89	6,10	6,99 5,10	6,10	6,99 5,11	6,10	6,92 4,89	5,49	6,56 4,72	-	-	-	-
SWW10.0X140	80	60	-	-	6,38	6,62 4,78	6,38	6,99 4,96	6,38	7,06 5,34	6,38	7,06 5,46	-	-	-	-	-	-	-	-
SWW10.0X160	80	80	-	-	6,38	6,62 4,78	6,38	6,99 4,96	6,38	7,06 5,34	6,38	7,06 5,46	6,38	7,06 5,67	6,38	7,06 5,67	6,38	7,06 5,67	-	-
SWW10.0X180	80	100	-	-	6,38	6,62 4,78	6,38	6,99 4,96	6,38	7,06 5,34	6,38	7,06 5,46	6,38	7,06 5,67	6,38	7,06 5,67	6,38	7,06 5,67	6,38	7,06 5,67
SWW10.0X200	80	120	-	-	6,38	6,62 4,78	6,38	6,99 4,96	6,38	7,06 5,34	6,38	7,06 5,46	6,38	7,06 5,67	6,38	7,06 5,67	6,38	7,06 5,67	6,38	7,06 5,67
SWW10.0X220	80	140	-	-	6,38	6,62 4,78	6,38	6,99 4,96	6,38	7,06 5,34	6,38	7,06 5,46	6,38	7,06 5,67	6,38	7,06 5,67	6,38	7,06 5,67	6,38	7,06 5,67
SWW10.0X240	80	160	-	-	6,38	6,62 4,78	6,38	6,99 4,96	6,38	7,06 5,34	6,38	7,06 5,46	6,38	7,06 5,67	6,38	7,06 5,67	6,38	7,06 5,67	6,38	7,06 5,67
SWW10.0X260	80	180	-	-	6,38	6,62 4,78	6,38	6,99 4,96	6,38	7,06 5,34	6,38	7,06 5,46	6,38	7,06 5,67	6,38	7,06 5,67	6,38	7,06 5,67	6,38	7,06 5,67
SWW10.0X280	80	200	-	-	6,38	6,62 4,78	6,38	6,99 4,96	6,38	7,06 5,34	6,38	7,06 5,46	6,38	7,06 5,67	6,38	7,06 5,67	6,38	7,06 5,67	6,38	7,06 5,67
SWW10.0X300	80	220	-	-	6,38	6,62 4,78	6,38	6,99 4,96	6,38	7,06 5,34	6,38	7,06 5,46	6,38	7,06 5,67	6,38	7,06 5,67	6,38	7,06 5,67	6,38	7,06 5,67
SWW10.0X320	80	240	-	-	6,38	6,62 4,78	6,38	6,99 4,96	6,38	7,06 5,34	6,38	7,06 5,46	6,38	7,06 5,67	6,38	7,06 5,67	6,38	7,06 5,67	6,38	7,06 5,67
SWW10.0X340	80	260	-	-	6,38	6,62 4,78	6,38	6,99 4,96	6,38	7,06 5,34	6,38	7,06 5,46	6,38	7,06 5,67	6,38	7,06 5,67	6,38	7,06 5,67	6,38	7,06 5,67
SWW10.0X360	80	280	-	-	6,38	6,62 4,78	6,38	6,99 4,96	6,38	7,06 5,34	6,38	7,06 5,46	6,38	7,06 5,67	6,38	7,06 5,67	6,38	7,06 5,67	6,38	7,06 5,67
SWW10.0X380	80	300	-	-	6,38	6,62 4,78	6,38	6,99 4,96	6,38	7,06 5,34	6,38	7,06 5,46	6,38	7,06 5,67	6,38	7,06 5,67	6,38	7,06 5,67	6,38	7,06 5,67
SWW10.0X400	80	320	-	-	6,38	6,62 4,78	6,38	6,99 4,96	6,38	7,06 5,34	6,38	7,06 5,46	6,38	7,06 5,67	6,38	7,06 5,67	6,38	7,06 5,67	6,38	7,06 5,67

For dimensions and calculation parameters see p. 44.

### 3.3.2 Solid Timber Wall-Plate to CLT Panel

## Solid-Drive™ SWC Countersunk WOOD Screw for Solid-Timber Wall-Plate to CLT Panel

**Yellow Zinc Plated**  
C2 acc. to EN ISO 12944-2  
SC2 - 50 years acc. to EC5

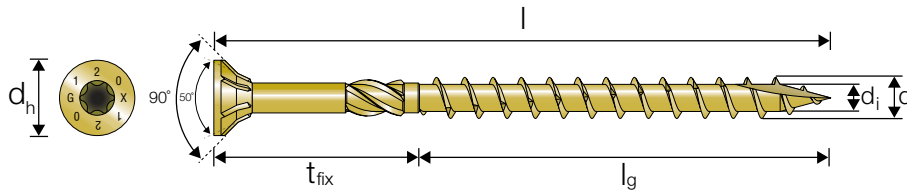

SWC - Solid-Timber Wall-Plate to CLT Panel - Screws at 90°  
Solid Timber C24 to CLT  $\rho_k = 350 \text{ kg/m}^3$

Product Reference	Thread Length $L_g$ [mm]	Max Advised Wood Thickness $t_1$ [mm]	Tension Capacity $R_{ax,k}$ Shear Capacity $R_{v,k}$ Depending on the Thickness of the Wall Plate [kN] - Screws at 90°																	
			Wall Plate Thickness $t_1$ [mm]																	
			36		45		50		60		63		70		75		80		100	
SWC6.0X200	70	130	1,66	2,53	1,66	2,53	1,66	2,53	1,66	2,53	1,66	2,53	1,66	2,53	1,66	2,53	1,66	2,53		
SWC6.0X220	70	150	1,66	2,53	1,66	2,53	1,66	2,53	1,66	2,53	1,66	2,53	1,66	2,53	1,66	2,53	1,66	2,53		
SWC6.0X240	70	170	1,66	2,53	1,66	2,53	1,66	2,53	1,66	2,53	1,66	2,53	1,66	2,53	1,66	2,53	1,66	2,53		
SWC6.0X260	70	190	1,66	2,53	1,66	2,53	1,66	2,53	1,66	2,53	1,66	2,53	1,66	2,53	1,66	2,53	1,66	2,53		
SWC6.0X280	70	210	1,66	2,53	1,66	2,53	1,66	2,53	1,66	2,53	1,66	2,53	1,66	2,53	1,66	2,53	1,66	2,53		
SWC6.0X300	70	230	1,66	2,53	1,66	2,53	1,66	2,53	1,66	2,53	1,66	2,53	1,66	2,53	1,66	2,53	1,66	2,53		

Table continues on next page.

CLT to CLT

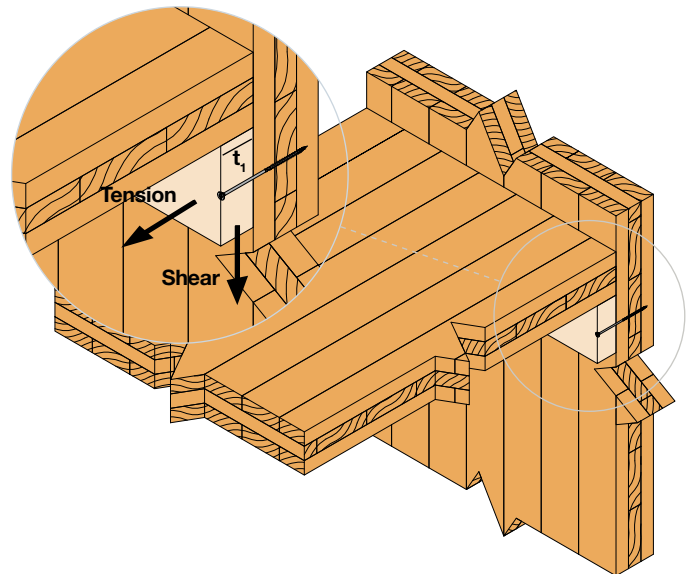
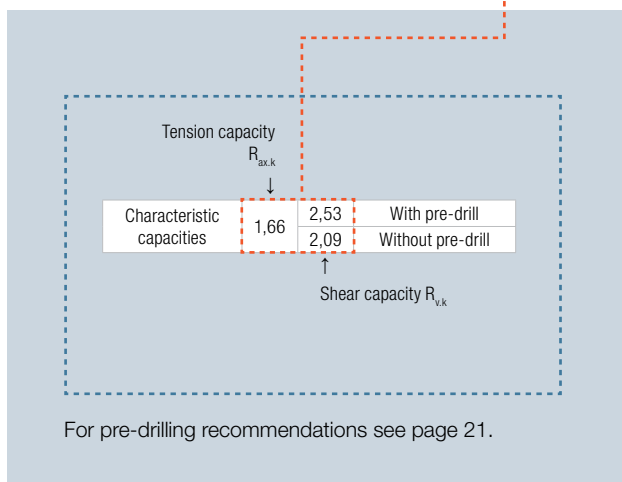

### 3.3.2 Solid Timber Wall-Plate to CLT Panel

SWC - Solid-Timber Wall-Plate to CLT Panel - Screws at 90°  
 Solid Timber C24 to CLT  $\rho_k = 350 \text{ kg/m}^3$  (cont.)

Product Reference	Thread Length $L_s$ [mm]	Max Advised Wood Thickness $t_1$ [mm]	Tension Capacity $R_{ax,k}$ Shear Capacity $R_{vk}$ Depending on the Thickness of the Wall Plate [kN] - Screws at 90°																
			Wall Plate Thickness $t_1$ [mm]																
			36		45		50		60		63		70		75		80		100
SWC8.0X100	50	50	2,66	4,04	2,66	4,47	2,66	4,47	-	-	-	-	-	-	-	-	-	-	-
SWC8.0X120	80	40	2,66	4,04	2,66	4,47	-	-	-	-	-	-	-	-	-	-	-	-	-
SWC8.0X140	80	60	2,66	4,04	2,66	4,47	2,66	4,47	2,66	4,47	2,66	4,47	-	-	-	-	-	-	-
SWC8.0X160	80	80	2,66	4,04	2,66	4,47	2,66	4,47	2,66	4,47	2,66	4,47	2,66	4,47	2,66	4,47	2,66	4,47	-
SWC8.0X180	80	100	2,66	4,04	2,66	4,47	2,66	4,47	2,66	4,47	2,66	4,47	2,66	4,47	2,66	4,47	2,66	4,47	2,66
SWC8.0X200	80	120	2,66	4,04	2,66	4,47	2,66	4,47	2,66	4,47	2,66	4,47	2,66	4,47	2,66	4,47	2,66	4,47	2,66
SWC8.0X220	80	140	2,66	4,04	2,66	4,47	2,66	4,47	2,66	4,47	2,66	4,47	2,66	4,47	2,66	4,47	2,66	4,47	2,66
SWC8.0X240	80	160	2,66	4,04	2,66	4,47	2,66	4,47	2,66	4,47	2,66	4,47	2,66	4,47	2,66	4,47	2,66	4,47	2,66
SWC8.0X260	80	180	2,66	4,04	2,66	4,47	2,66	4,47	2,66	4,47	2,66	4,47	2,66	4,47	2,66	4,47	2,66	4,47	2,66
SWC8.0X280	80	200	2,66	4,04	2,66	4,47	2,66	4,47	2,66	4,47	2,66	4,47	2,66	4,47	2,66	4,47	2,66	4,47	2,66
SWC8.0X300	80	220	2,66	4,04	2,66	4,47	2,66	4,47	2,66	4,47	2,66	4,47	2,66	4,47	2,66	4,47	2,66	4,47	2,66
SWC8.0X320	80	240	2,66	4,04	2,66	4,47	2,66	4,47	2,66	4,47	2,66	4,47	2,66	4,47	2,66	4,47	2,66	4,47	2,66
SWC8.0X340	80	260	2,66	4,04	2,66	4,47	2,66	4,47	2,66	4,47	2,66	4,47	2,66	4,47	2,66	4,47	2,66	4,47	2,66
SWC8.0X360	80	280	2,66	4,04	2,66	4,47	2,66	4,47	2,66	4,47	2,66	4,47	2,66	4,47	2,66	4,47	2,66	4,47	2,66
SWC8.0X380	80	300	2,66	4,04	2,66	4,47	2,66	4,47	2,66	4,47	2,66	4,47	2,66	4,47	2,66	4,47	2,66	4,47	2,66
SWC8.0X400	80	320	2,66	4,04	2,66	4,47	2,66	4,47	2,66	4,47	2,66	4,47	2,66	4,47	2,66	4,47	2,66	4,47	2,66
SWC10.0X100	50	50	-	-	3,55	5,92	3,55	6,24	-	-	-	-	-	-	-	-	-	-	-
SWC10.0X120	50	70	-	-	3,55	5,92	3,55	6,28	3,55	6,35	3,55	6,35	3,55	6,28	3,55	5,92	-	-	-
SWC10.0X140	80	60	-	-	3,55	5,92	3,55	6,28	3,55	6,35	3,55	6,35	-	-	-	-	-	-	-
SWC10.0X160	80	80	-	-	3,55	5,92	3,55	6,28	3,55	6,35	3,55	6,35	3,55	6,35	3,55	6,35	3,55	6,35	-
SWC10.0X180	80	100	-	-	3,55	5,92	3,55	6,28	3,55	6,35	3,55	6,35	3,55	6,35	3,55	6,35	3,55	6,35	3,55
SWC10.0X200	80	120	-	-	3,55	5,92	3,55	6,28	3,55	6,35	3,55	6,35	3,55	6,35	3,55	6,35	3,55	6,35	3,55
SWC10.0X220	80	140	-	-	3,55	5,92	3,55	6,28	3,55	6,35	3,55	6,35	3,55	6,35	3,55	6,35	3,55	6,35	3,55
SWC10.0X240	80	160	-	-	3,55	5,92	3,55	6,28	3,55	6,35	3,55	6,35	3,55	6,35	3,55	6,35	3,55	6,35	3,55
SWC10.0X260	80	180	-	-	3,55	5,92	3,55	6,28	3,55	6,35	3,55	6,35	3,55	6,35	3,55	6,35	3,55	6,35	3,55
SWC10.0X280	80	200	-	-	3,55	5,92	3,55	6,28	3,55	6,35	3,55	6,35	3,55	6,35	3,55	6,35	3,55	6,35	3,55
SWC10.0X300	80	220	-	-	3,55	5,92	3,55	6,28	3,55	6,35	3,55	6,35	3,55	6,35	3,55	6,35	3,55	6,35	3,55
SWC10.0X320	80	240	-	-	3,55	5,92	3,55	6,28	3,55	6,35	3,55	6,35	3,55	6,35	3,55	6,35	3,55	6,35	3,55
SWC10.0X340	80	260	-	-	3,55	5,92	3,55	6,28	3,55	6,35	3,55	6,35	3,55	6,35	3,55	6,35	3,55	6,35	3,55
SWC10.0X360	80	280	-	-	3,55	5,92	3,55	6,28	3,55	6,35	3,55	6,35	3,55	6,35	3,55	6,35	3,55	6,35	3,55
SWC10.0X380	80	300	-	-	3,55	5,92	3,55	6,28	3,55	6,35	3,55	6,35	3,55	6,35	3,55	6,35	3,55	6,35	3,55
SWC10.0X400	80	320	-	-	3,55	5,92	3,55	6,28	3,55	6,35	3,55	6,35	3,55	6,35	3,55	6,35	3,55	6,35	3,55

For dimensions and calculation parameters see p. 48.

### 3.3.2 Solid Timber Wall-Plate to CLT Panel

#### Minimum Distances for Screws Wall-Plate to CLT Panel

##### TTUFS

Dimensions	Pre-drill*	$a_{4,c}$	$a_{4,t}$
5.0xℓ	With pre-drill	15	35
	Without pre-drill	25	35
6.0xℓ	With pre-drill	18	42
	Without pre-drill	30	42

\*If Pre-drill - just the wall plate

##### SWW

Dimensions	Pre-drill*	$a_{4,c}$	$a_{4,t}$
6.0xℓ	With pre-drill	18	42
	Without pre-drill	30	42
8.0xℓ	With pre-drill	24	56
	Without pre-drill	40	56
10.0xℓ	With pre-drill	30	70
	Without pre-drill	50	70

\*If Pre-drill - just the wall plate

##### SWC

Dimensions	Pre-drill*	$a_{4,c}$	$a_{4,t}$
6.0xℓ	With pre-drill	18	42
	Without pre-drill	30	42
8.0xℓ	With pre-drill	24	56
	Without pre-drill	40	56
10.0xℓ	With pre-drill	30	70
	Without pre-drill	50	70

\*If Pre-drill - just the wall plate

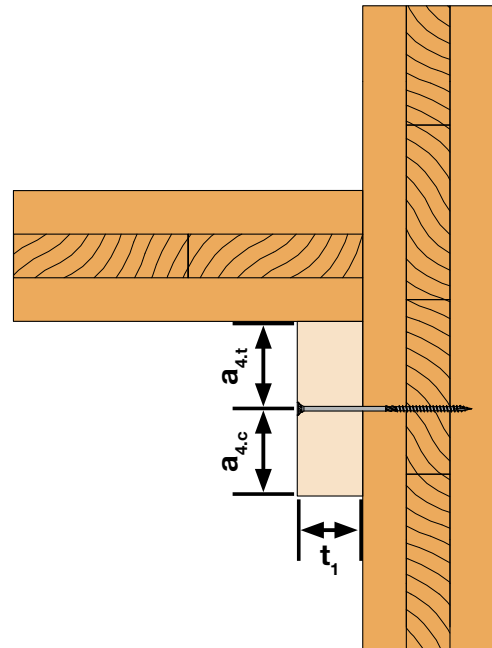

### 3.3.2 Solid Timber Wall-Plate to CLT Panel

## **Solid-Drive™** SWD Double Threaded **WOOD** Screw for Solid-Timber Wall-Plate to CLT Panel

Protec® +

C3 acc. to EN ISO 12944-2  
SC2 - 50 years acc. to EC5

UK  
CA



ETA-21/0670

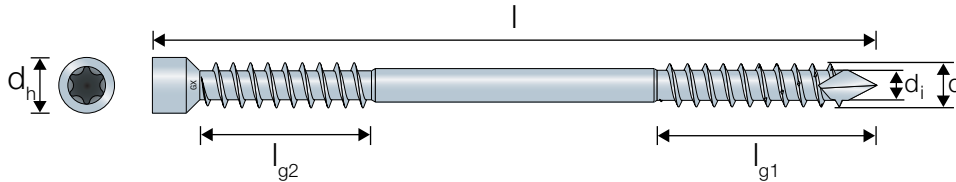

SWD - Solid-Timber Wall-Plate to CLT Panel - Screws at 45°  
Solid Timber C24 to CLT  $\rho_k = 350 \text{ kg/m}^3$

Product Reference	Minimum Thickness	Shear Capacity $R_{v,45,k}$ [kN] - Screws at 45°
	$B_{min}$ [mm]	
SWD6.5X65	23	1,8
SWD6.5X90	32	2,5
SWD6.5X130	46	2,5
SWD6.5X160	57	4,1
SWD6.5X190	68	5,0
SWD6.5X220	78	6,0
SWD8.0X90	32	3,0
SWD8.0X130	46	3,0
SWD8.0X160	57	4,8
SWD8.0X190	68	5,9
SWD8.0X220	78	7,0
SWD8.0X245	87	7,9
SWD8.0X275	98	7,9
SWD8.0X300	107	10,0
SWD8.0X330	117	10,0

For dimensions and calculation parameters see p. 50.

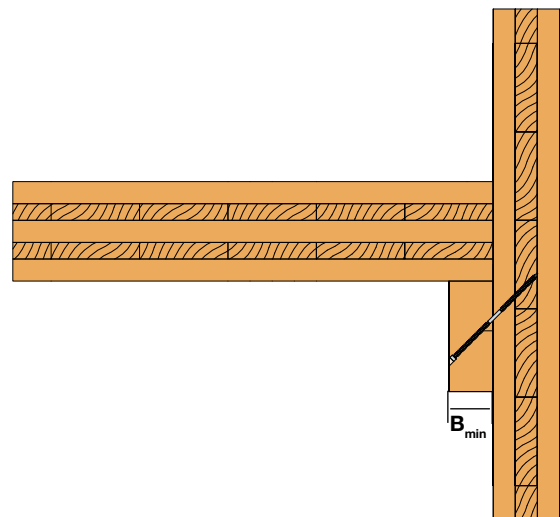
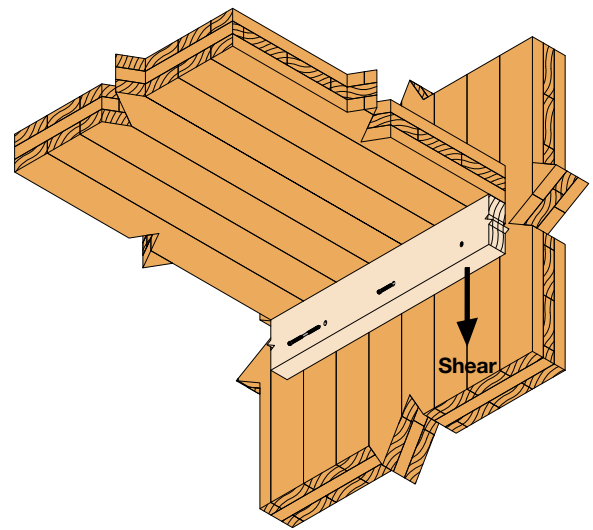

### 3.3.2 Solid Timber Wall-Plate to CLT Panel

**Solid-Drive™**

ESCRFTZ Full Threaded **WOOD** Screw  
for Solid-Timber Wall-Plate to CLT Panel

Yellow Zinc Plated  
C2 acc. to EN ISO 12944-2  
SC2 - 50 years acc. to EC5

UK  
CA



ETA-13/0796

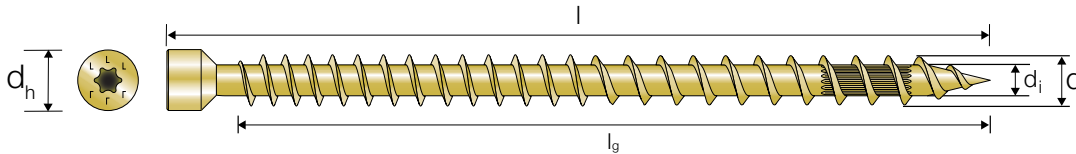

ESCRFTZ - Solid-Timber Wall-Plate to CLT Panel - Screws at 45°  
Solid Timber C24 to CLT  $\rho_k = 350 \text{ kg/m}^3$

Product Reference	Minimum Thickness	Shear Capacity $R_{v,45,k}$ [kN] - Screws at 45°
	$B_{\min}$ [mm]	
ESCRFTZ8.0X120	43	3,7
ESCRFTZ8.0X140	50	4,4
ESCRFTZ8.0X160	57	5,2
ESCRFTZ8.0X180	64	5,9
ESCRFTZ8.0X200	71	6,7
ESCRFTZ8.0X220	78	7,4
ESCRFTZ8.0X240	85	8,2
ESCRFTZ8.0X260	92	8,9
ESCRFTZ8.0X280	99	9,6
ESCRFTZ8.0X300	107	10,4
ESCRFTZ8.0X350	124	12,2
ESCRFTZ8.0X400	142	14,1

For dimensions and calculation parameters see p. 58.

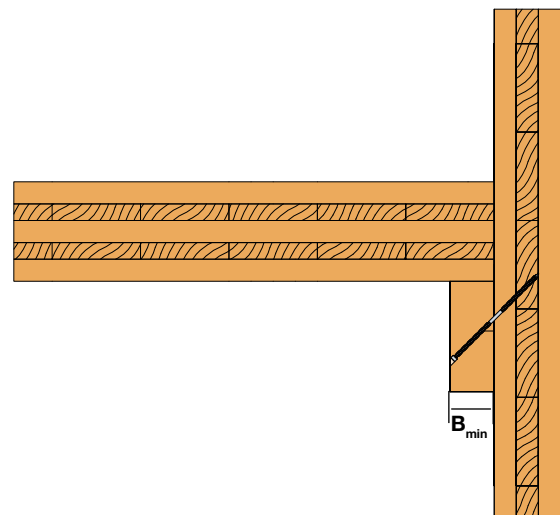
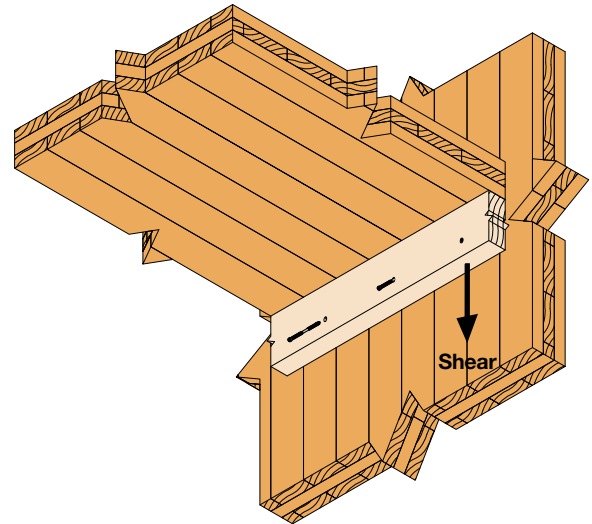

### 3.3.2 Solid Timber Wall-Plate to CLT Panel

## **Solid-Drive™** ESCRFTC Full Threaded **WOOD** Screw for Solid-Timber Wall-Plate to CLT Panel

**Yellow Zinc Plated**  
C2 acc. to EN ISO 12944-2  
SC2 - 50 years acc. to EC5

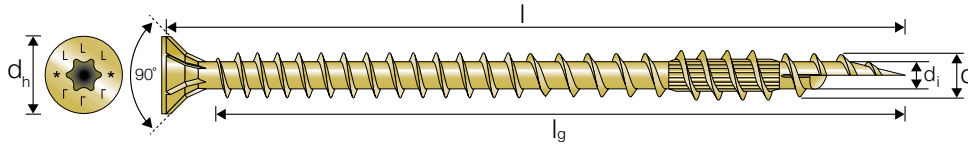

ESCRFTC - Solid-Timber Wall-Plate to CLT Panel - Screws at 45°  
Solid Timber C24 to CLT  $\rho_k = 350 \text{ kg/m}^3$

Product Reference	Minimum Thickness	Shear Capacity $R_{v,45,k}$ [kN] - Screws at 45°
	$B_{min}$ [mm]	
ESCRFTC8.0X120	43	3,7
ESCRFTC8.0X140	50	4,4
ESCRFTC8.0X160	57	5,2
ESCRFTC8.0X180	64	5,9
ESCRFTC8.0X200	71	6,7
ESCRFTC8.0X220	78	7,4
ESCRFTC8.0X240	85	8,2
ESCRFTC8.0X260	92	8,9
ESCRFTC8.0X280	99	9,6
ESCRFTC8.0X300	107	10,4
ESCRFTC8.0X350	124	12,2
ESCRFTC8.0X400	142	14,1
ESCRFTC8.0X450	160	14,5
ESCRFTC10.0X120	43	4,2
ESCRFTC10.0X160	57	5,9
ESCRFTC10.0X180	64	6,8
ESCRFTC10.0X200	71	7,7
ESCRFTC10.0X220	78	8,6
ESCRFTC10.0X240	85	9,5
ESCRFTC10.0X260	92	10,3
ESCRFTC10.0X280	99	11,2
ESCRFTC10.0X300	107	12,1
ESCRFTC10.0X350	124	14,3
ESCRFTC10.0X400	142	14,9
ESCRFTC10.0X450	160	17,1
ESCRFTC12.0X200	71	7,1
ESCRFTC12.0X220	78	8,1
ESCRFTC12.0X240	85	9,0
ESCRFTC12.0X260	92	10,0
ESCRFTC12.0X280	99	10,9
ESCRFTC12.0X300	107	11,9
ESCRFTC12.0X350	124	14,3
ESCRFTC12.0X400	142	16,6
ESCRFTC12.0X450	160	19,0
ESCRFTC12.0X500	177	21,4
ESCRFTC12.0X600	213	26,1

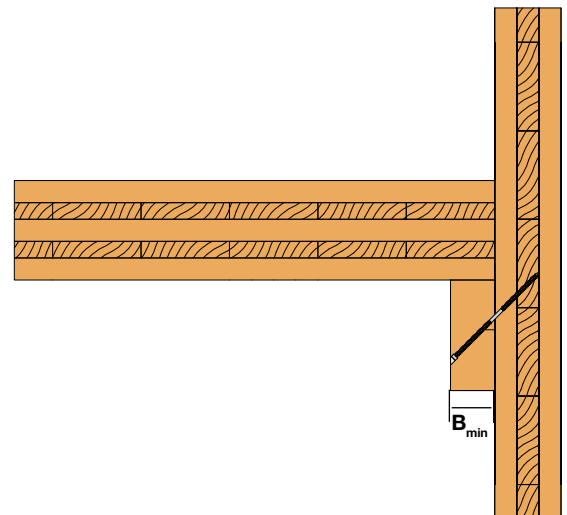
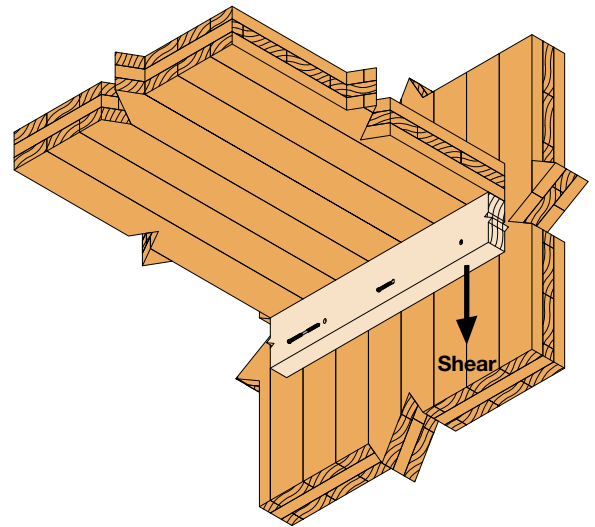

CLT to CLT

For dimensions and calculation parameters see p. 56.



### 3.3.2 Solid Timber Wall-Plate to CLT Panel

## **Solid-Drive™** ESCRFT Full Threaded **WOOD** Screw for Solid-Timber Wall-Plate to CLT Panel

**Yellow Zinc Plated**  
C2 acc. to EN ISO 12944-2  
SC2 - 50 years acc. to EC5

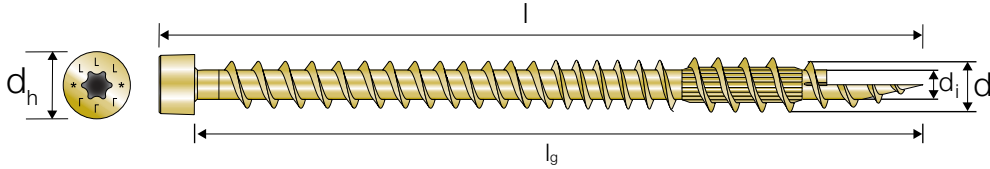

ESCRFT - Solid-Timber Wall-Plate to CLT Panel - Screws at 45°  
Solid Timber C24 to CLT  $\rho_k = 350 \text{ kg/m}^3$

Product Reference	Minimum Thickness	Shear Capacity $R_{v,45,k}$ [kN] - Screws at 45°
	$B_{min}$ [mm]	
ESCRFT10.0X450	160	17,1
ESCRFT10.0X500	177	19,4
ESCRFT10.0X600	213	23,8
ESCRFT10.0X800	283	28,3
ESCRFT10.0X1000	354	28,3

For dimensions and calculation parameters see p. 60.

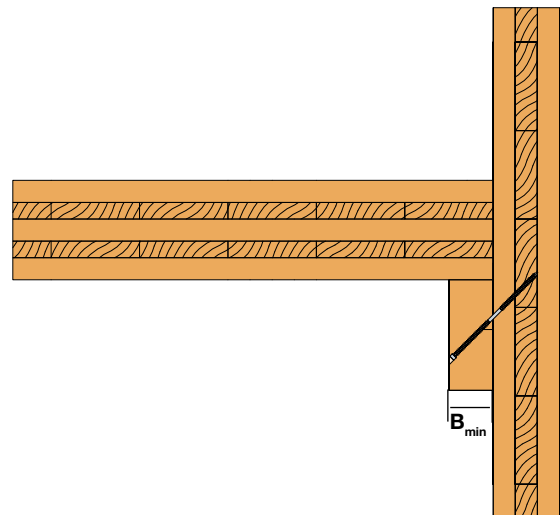
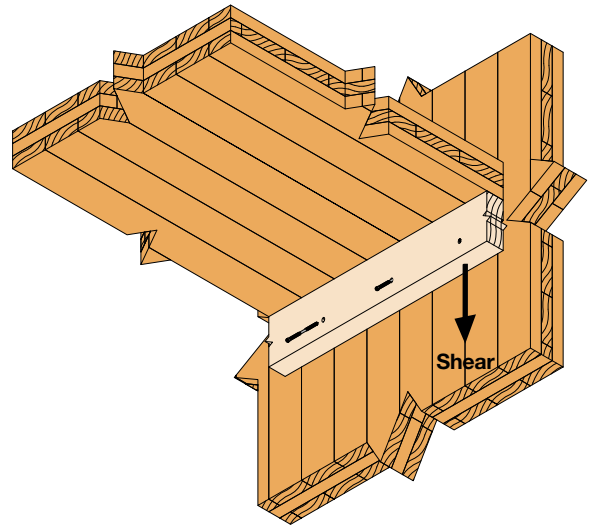

### 3.3.2 Solid Timber Wall-Plate to CLT Panel

#### Minimum Distances for Screws

#### Solid-Timber Wall-Plate to CLT Connection - Screws at 45°

##### SWD

Dimensions	$a_{4,c}$
6.5xℓ	26
8.0xℓ	32

##### ESCRFTZ/ESCRFT

Dimensions	$a_{4,c}$
8.0xℓ	32
10.0xℓ	40

##### ESCRFTC

Dimensions	$a_{4,c}$
8.0xℓ	32
10.0xℓ	40
12.0xℓ	48

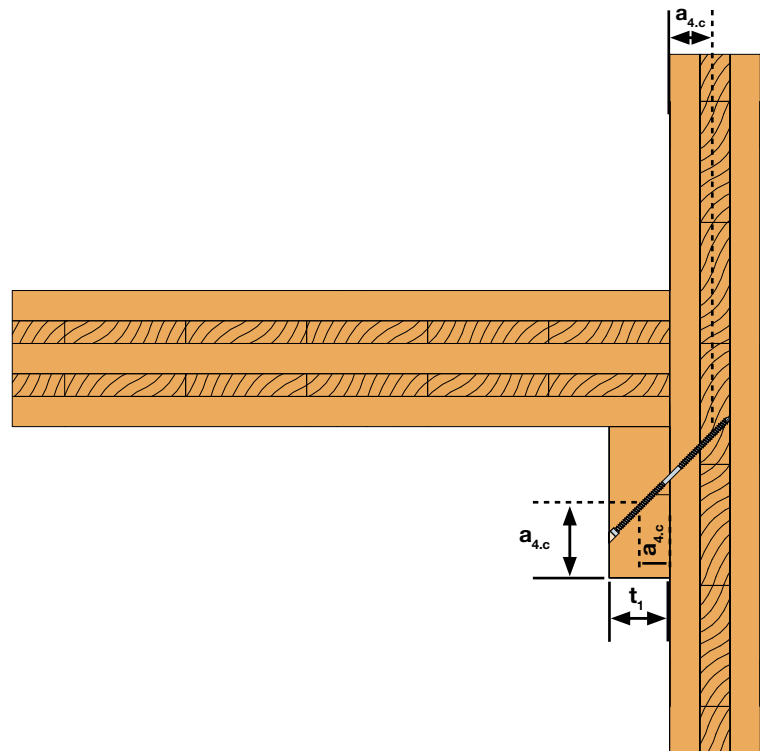

### 3.3.3 CLT Half-Lap Connection

## Solid-Drive™ TTUFS Countersunk WOOD Screw for Half-Lap CLT Connection

**Electro Galvanised**  
C1 acc. to EN ISO 12944-2  
SC2 - 50 years acc. to EC5



ETA-21/0670

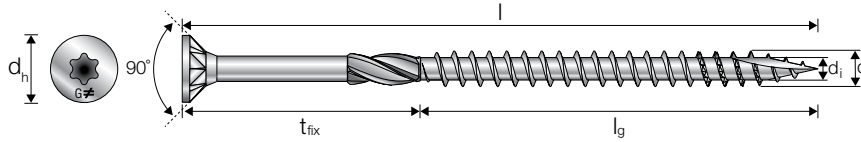

TTUFS - Half-Lap Connection - Screws at 90°  
CLT to CLT  $\rho_k = 350 \text{ kg/m}^3$

Product Reference	Predrilling	Minimum Thickness of the Panel	Shear (X or Y) Capacity $R_{yk}$ [kN] - Screws at 90°
		$h_{min}$	
TTUFS4.5X70	With predrill	80	1,5
	Without predrill	80	1,3
TTUFS4.5X80	With predrill	100	1,5
	Without predrill	100	1,3

Table continues on next page.

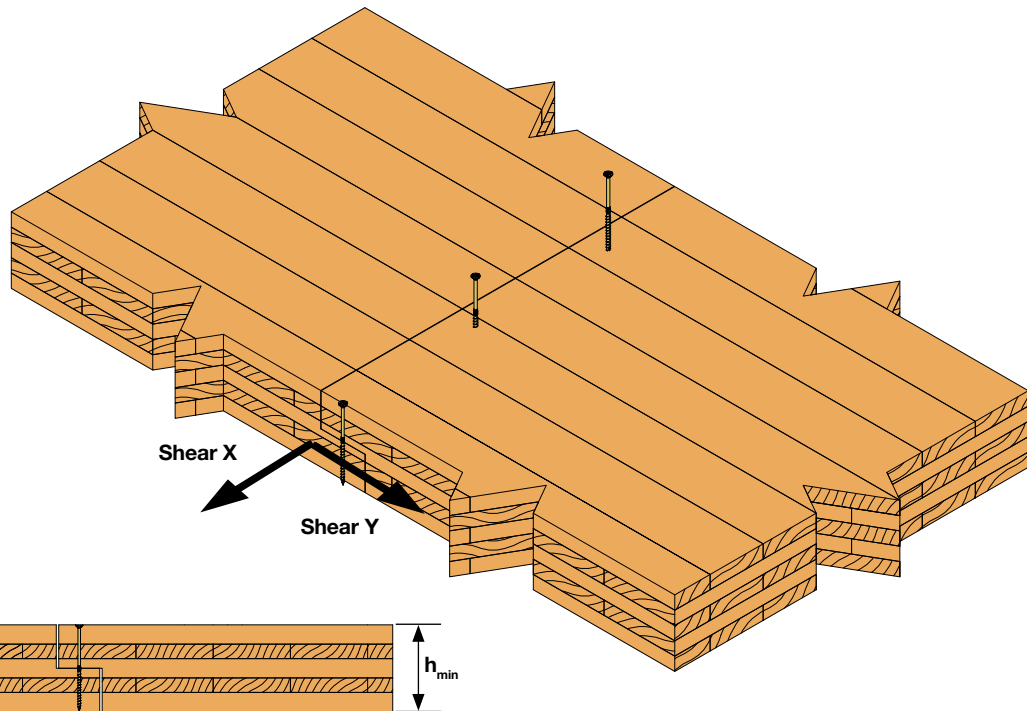

### 3.3.3 CLT Half-Lap Connection

TTUFS - Half-Lap Connection - Screws at 90°  
CLT to CLT  $\rho_k = 350 \text{ kg/m}^3$  (cont.)

Product Reference	Predrilling	Minimum Thickness of the Panel	Shear (X or Y) Capacity $R_{v,k}$ [kN] - Screws at 90°
		$h_{min}$	
TTUFS5.0X70	With predrill	80	1,9
	Without predrill	80	1,6
TTUFS5.0X80	With predrill	90	1,9
	Without predrill	90	1,6
TTUFS5.0X90	With predrill	100	1,9
	Without predrill	100	1,6
TTUFS5.0X100	With predrill	120	1,9
	Without predrill	120	1,6
TTUFS5.0X120	With predrill	130	1,9
	Without predrill	130	1,6

Product Reference	Predrilling	Minimum Thickness of the Panel	Shear (X or Y) Capacity $R_{v,k}$ [kN] - Screws at 90°
		$h_{min}$	
TTUFS6.0X70	With predrill	80	2,6
	Without predrill	80	2,0
TTUFS6.0X80	With predrill	90	2,6
	Without predrill	90	2,1
TTUFS6.0X90	With predrill	100	2,6
	Without predrill	100	2,1
TTUFS6.0X100	With predrill	120	2,6
	Without predrill	120	2,1
TTUFS6.0X120	With predrill	140	2,6
	Without predrill	140	2,1
TTUFS6.0X140	With predrill	150	2,6
	Without predrill	150	2,1
TTUFS6.0X160	With predrill	170	2,6
	Without predrill	170	2,1
TTUFS6.0X180	With predrill	190	2,6
	Without predrill	190	2,1

For dimensions and calculation parameters see p. 40.

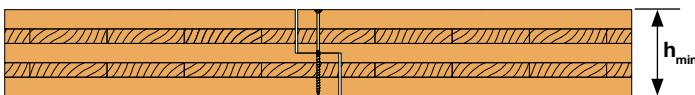
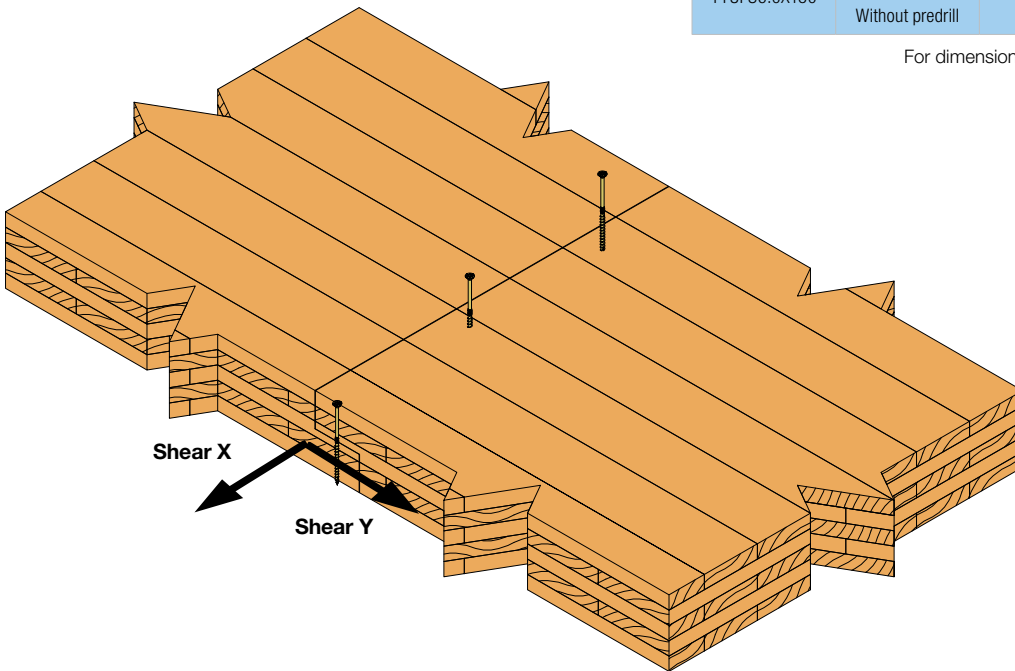

### 3.3.3 CLT Half-Lap Connection

## Solid-Drive™ SWW Washer-Head WOOD Screw for Half-Lap CLT Connection

Yellow Zinc Plated  
C2 acc. to EN ISO 12944-2  
SC2 - 50 years acc. to EC5



ETA-21/0670

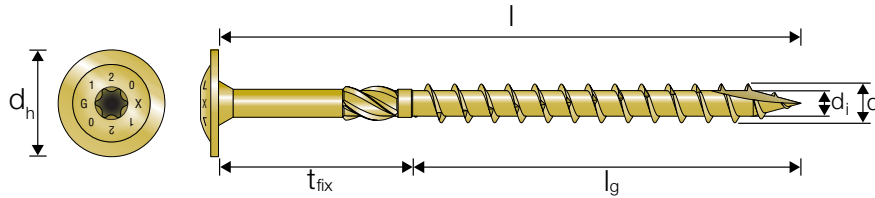

SWW - Half-Lap Connection - Screws at 90°  
CLT to CLT  $\rho_k = 350 \text{ kg/m}^3$

Product Reference	Predrilling	Minimum Thickness of the Panel	Shear (X or Y) Capacity $R_{v,k}$ [kN] - Screws at 90°
		$h_{min}$	
SWW6.0X80	With predrill	100	2,9
	Without predrill	100	2,3
SWW6.0X90	With predrill	100	2,9
	Without predrill	100	2,5
SWW6.0X100	With predrill	110	2,9
	Without predrill	110	2,5
SWW6.0X120	With predrill	130	2,9
	Without predrill	130	2,5
SWW6.0X140	With predrill	150	2,9
	Without predrill	150	2,5
SWW6.0X160	With predrill	170	2,9
	Without predrill	170	2,5

Product Reference	Predrilling	Minimum Thickness of the Panel	Shear (X or Y) Capacity $R_{v,k}$ [kN] - Screws at 90°
		$h_{min}$	
SWW6.0X180	With predrill	190	2,9
	Without predrill	190	2,5
SWW6.0X200	With predrill	210	2,9
	Without predrill	210	2,5
SWW6.0X220	With predrill	230	2,9
	Without predrill	230	2,5
SWW6.0X240	With predrill	250	2,9
	Without predrill	250	2,5
SWW6.0X260	With predrill	270	2,9
	Without predrill	270	2,5
SWW6.0X280	With predrill	290	2,9
	Without predrill	290	2,5
SWW6.0X300	With predrill	310	2,9
	Without predrill	310	2,5

Table continues on next page.

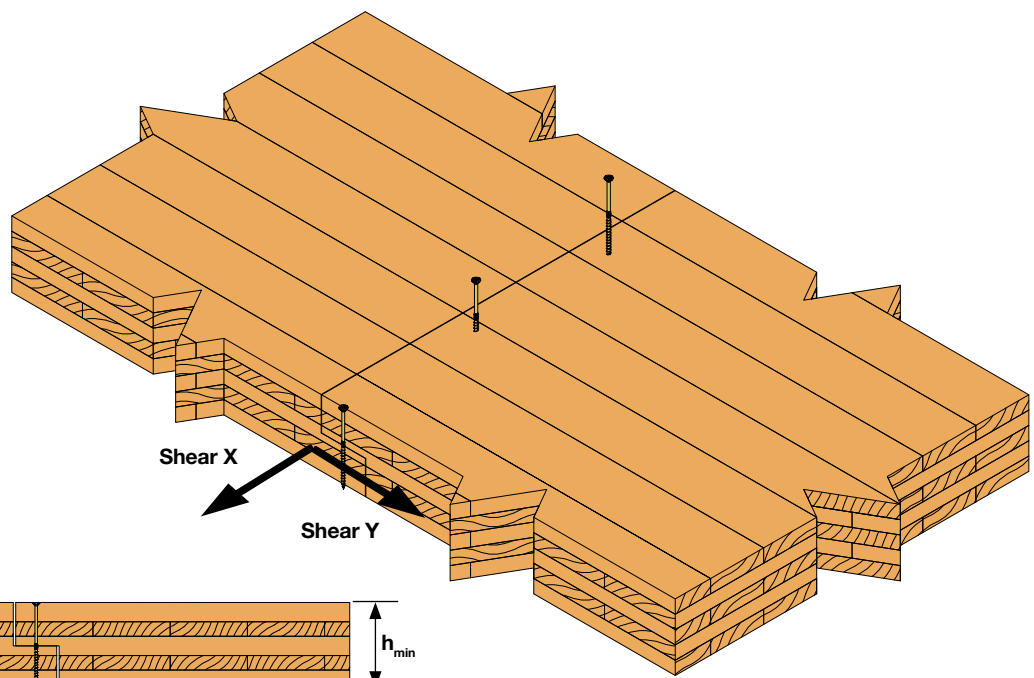

### 3.3.3 CLT Half-Lap Connection

SWW - Half-Lap Connection - Screws at 90°  
CLT to CLT  $\rho_k = 350 \text{ kg/m}^3$  (cont.)

Product Reference	Predrilling	Minimum Thickness of the Panel	Shear (X or Y) Capacity $R_{v,k}$ [kN] - Screws at 90°
		$h_{\min}$	
SWW8.0X80	With predrill	100	4,6
	Without predrill	100	3,3
SWW8.0X90	With predrill	100	5,1
	Without predrill	100	3,6
SWW8.0X100	With predrill	110	5,1
	Without predrill	110	3,8
SWW8.0X120	With predrill	160	5,1
	Without predrill	160	3,8
SWW8.0X140	With predrill	160	5,1
	Without predrill	160	4,2
SWW8.0X160	With predrill	170	5,1
	Without predrill	170	4,2
SWW8.0X180	With predrill	190	5,1
	Without predrill	190	4,2
SWW8.0X200	With predrill	210	5,1
	Without predrill	210	4,2
SWW8.0X220	With predrill	230	5,1
	Without predrill	230	4,2
SWW8.0X240	With predrill	250	5,1
	Without predrill	250	4,2
SWW8.0X260	With predrill	270	5,1
	Without predrill	270	4,2
SWW8.0X280	With predrill	290	5,1
	Without predrill	290	4,2
SWW8.0X300	With predrill	310	5,1
	Without predrill	310	4,2
SWW8.0X320	With predrill	330	5,1
	Without predrill	330	4,2
SWW8.0X340	With predrill	350	5,1
	Without predrill	350	4,2
SWW8.0X360	With predrill	370	5,1
	Without predrill	370	4,2
SWW8.0X380	With predrill	390	5,1
	Without predrill	390	4,2
SWW8.0X400	With predrill	410	5,1
	Without predrill	410	4,2

Product Reference	Predrilling	Minimum Thickness of the Panel	Shear (X or Y) Capacity $R_{v,t}$ [kN] - Screws at 90°
		$h_{\min}$	
SWW10.0X100	With predrill	110	6,9
	Without predrill	110	4,6
SWW10.0X120	With predrill	130	7,0
	Without predrill	130	5,1
SWW10.0X140	With predrill	160	7,1
	Without predrill	160	5,5
SWW10.0X160	With predrill	170	7,1
	Without predrill	170	5,7
SWW10.0X180	With predrill	190	7,1
	Without predrill	190	5,7
SWW10.0X200	With predrill	210	7,1
	Without predrill	210	5,7
SWW10.0X220	With predrill	230	7,1
	Without predrill	230	5,7
SWW10.0X240	With predrill	250	7,1
	Without predrill	250	5,7
SWW10.0X260	With predrill	270	7,1
	Without predrill	270	5,7
SWW10.0X280	With predrill	290	7,1
	Without predrill	290	5,7
SWW10.0X300	With predrill	310	7,1
	Without predrill	310	5,7
SWW10.0X320	With predrill	330	7,1
	Without predrill	330	5,7
SWW10.0X340	With predrill	350	7,1
	Without predrill	350	5,7
SWW10.0X360	With predrill	370	7,1
	Without predrill	370	5,7
SWW10.0X380	With predrill	390	7,1
	Without predrill	390	5,7
SWW10.0X400	With predrill	410	7,1
	Without predrill	410	5,7

For dimensions and calculation parameters see p. 44.

### 3.3.3 CLT Half-Lap Connection

## Solid-Drive™ SWC Countersunk WOOD Screw for Half-Lap CLT Connection

Yellow Zinc Plated  
C2 acc. to EN ISO 12944-2  
SC2 - 50 years acc. to EC5

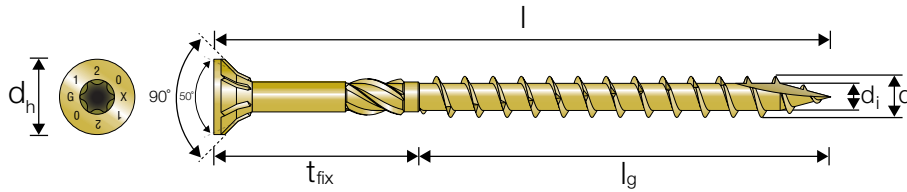

SWC - Half-Lap Connection - Screws at 90°  
CLT to CLT  $\rho_k = 350 \text{ kg/m}^3$

Product Reference	Predrilling	Minimum Thickness of the Panel	Shear (X or Y) Capacity $R_{v,k}$ [kN] - Screws at 90°
		$h_{min}$	
SWC6.0X60	With predrill	84	0,0
	Without predrill	84	0,0
SWC6.0X80	With predrill	100	2,5
	Without predrill	100	1,9
SWC6.0X90	With predrill	100	2,5
	Without predrill	100	2,1
SWC6.0X100	With predrill	110	2,5
	Without predrill	110	2,1
SWC6.0X120	With predrill	130	2,5
	Without predrill	130	2,1
SWC6.0X140	With predrill	150	2,5
	Without predrill	150	2,1
SWC6.0X160	With predrill	170	2,5
	Without predrill	170	2,1

Product Reference	Predrilling	Minimum Thickness of the Panel	Shear (X or Y) Capacity $R_{v,k}$ [kN] - Screws at 90°
		$h_{min}$	
SWC6.0X180	With predrill	190	2,5
	Without predrill	190	2,1
SWC6.0X200	With predrill	210	2,5
	Without predrill	210	2,1
SWC6.0X220	With predrill	230	2,5
	Without predrill	230	2,1
SWC6.0X240	With predrill	250	2,5
	Without predrill	250	2,1
SWC6.0X260	With predrill	270	2,5
	Without predrill	270	2,1
SWC6.0X280	With predrill	290	2,5
	Without predrill	290	2,1
SWC6.0X300	With predrill	310	2,5
	Without predrill	310	2,1

Table continues on next page.

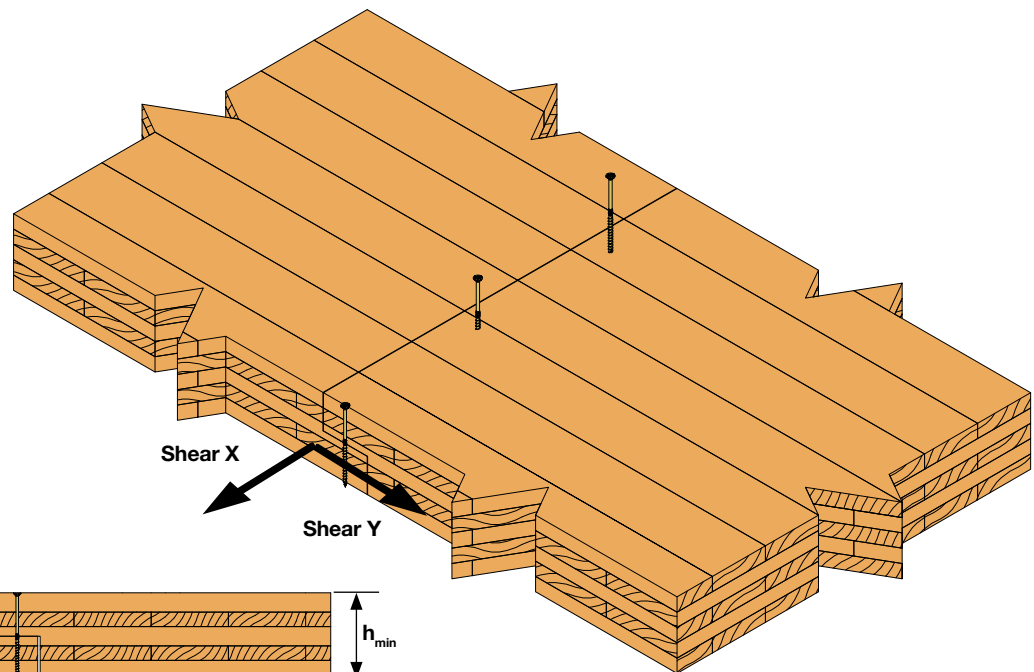



### 3.3.3 CLT Half-Lap Connection

SWC - Half-Lap Connection - Screws at 90°  
CLT to CLT  $\rho_k = 350 \text{ kg/m}^3$  (cont.)

Product Reference	Predrilling	Minimum Thickness of the Panel	Shear (X or Y) Capacity $R_{v,k}$ [kN] - Screws at 90°
		$h_{\min}$	
SWC8.0X80	With predrill	100	4,0
	Without predrill	100	2,7
SWC8.0X90	With predrill	100	4,5
	Without predrill	100	3,0
SWC8.0X100	With predrill	110	4,5
	Without predrill	110	3,2
SWC8.0X120	With predrill	160	4,5
	Without predrill	160	3,2
SWC8.0X140	With predrill	160	4,5
	Without predrill	160	3,6
SWC8.0X160	With predrill	170	4,5
	Without predrill	170	3,6
SWC8.0X180	With predrill	190	4,5
	Without predrill	190	3,6
SWC8.0X200	With predrill	210	4,5
	Without predrill	210	3,6
SWC8.0X220	With predrill	230	4,5
	Without predrill	230	3,6
SWC8.0X240	With predrill	250	4,5
	Without predrill	250	3,6
SWC8.0X260	With predrill	270	4,5
	Without predrill	270	3,6
SWC8.0X280	With predrill	290	4,5
	Without predrill	290	3,6
SWC8.0X300	With predrill	310	4,5
	Without predrill	310	3,6
SWC8.0X320	With predrill	330	4,5
	Without predrill	330	3,6
SWC8.0X340	With predrill	350	4,5
	Without predrill	350	3,6
SWC8.0X360	With predrill	370	4,5
	Without predrill	370	3,6
SWC8.0X380	With predrill	390	4,5
	Without predrill	390	3,6
SWC8.0X400	With predrill	410	4,5
	Without predrill	410	3,6

Product Reference	Predrilling	Minimum Thickness of the Panel	Shear (X or Y) Capacity $R_{v,t}$ [kN] - Screws at 90°
		$h_{\min}$	
SWC10.0X100	With predrill	110	6,2
	Without predrill	110	3,9
SWC10.0X120	With predrill	130	6,4
	Without predrill	130	4,5
SWC10.0X140	With predrill	160	6,4
	Without predrill	160	4,7
SWC10.0X160	With predrill	170	6,4
	Without predrill	170	5,0
SWC10.0X180	With predrill	190	6,4
	Without predrill	190	5,0
SWC10.0X200	With predrill	210	6,4
	Without predrill	210	5,0
SWC10.0X220	With predrill	230	6,4
	Without predrill	230	5,0
SWC10.0X240	With predrill	250	6,4
	Without predrill	250	5,0
SWC10.0X260	With predrill	270	6,4
	Without predrill	270	5,0
SWC10.0X280	With predrill	290	6,4
	Without predrill	290	5,0
SWC10.0X300	With predrill	310	6,4
	Without predrill	310	5,0
SWC10.0X320	With predrill	330	6,4
	Without predrill	330	5,0
SWC10.0X340	With predrill	350	6,4
	Without predrill	350	5,0
SWC10.0X360	With predrill	370	6,4
	Without predrill	370	5,0
SWC10.0X380	With predrill	390	6,4
	Without predrill	390	5,0
SWC10.0X400	With predrill	410	6,4
	Without predrill	410	5,0

For dimensions and calculation parameters see p. 48.

### 3.3.3 CLT Half-Lap Connection

#### Minimum Distances for Screws CLT Half-Lap Connection

##### TTUFS

Dimensions	$a_{3,c}$
4.5xℓ	27
5.0xℓ	30
6.0xℓ	36

##### SWW

Dimensions	$a_{3,c}$
6.0xℓ	36
8.0xℓ	48
10.0xℓ	60

##### SWC

Dimensions	$a_{3,c}$
6.0xℓ	36
8.0xℓ	48
10.0xℓ	60

Valid for both pre-drilled and non pre-drilled

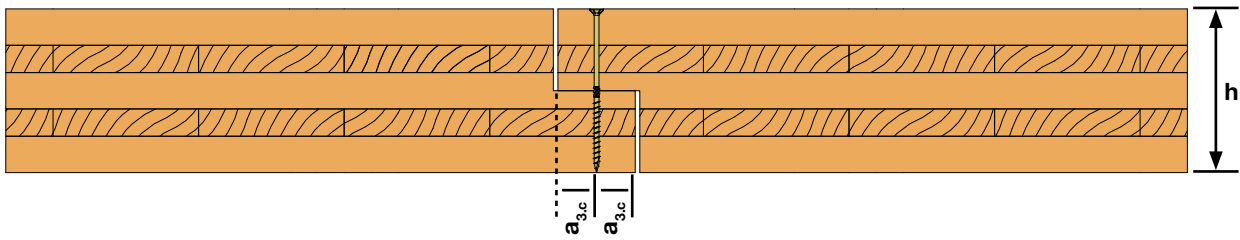

### 3.3.3 CLT Half-Lap Connection

## Solid-Drive™ SWD Double Threaded WOOD Screw for Half-Lap CLT Connection

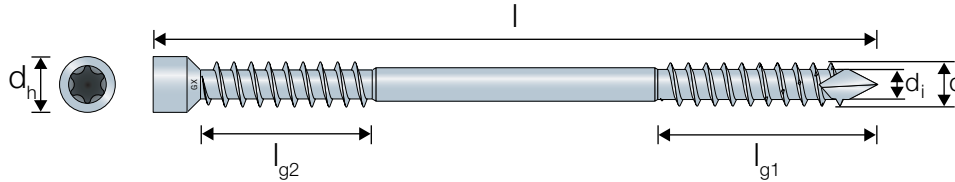

SWD - Half-Lap Connection - Per Pair  $R_{v,k}$  [kN] =  $\min(R_{w,k, pair}; R_{buck,k, pair})$  - 45° Cross Pairs  
CLT to CLT  $\rho_k = 350 \text{ kg/m}^3$

Product Reference	Minimum Thickness of the Panel	Shear (X) Characteristic Capacity per Pair $R_{v,k}$ [kN] - Cross Pairs of Screws	
	$h_{min}$	$R_{w,k, pair}$	$R_{buck,k, pair}$
SWD6.5X65	51	3,5	$14.59 + 13.99 / k_{mod}$
SWD6.5X90	69	5,0	$14.59 + 13.99 / k_{mod}$
SWD6.5X130	97	5,0	$14.59 + 13.99 / k_{mod}$
SWD6.5X160	118	8,2	$14.59 + 13.99 / k_{mod}$
SWD6.5X190	139	10,1	$14.59 + 13.99 / k_{mod}$
SWD6.5X220	161	12,0	$14.59 + 13.99 / k_{mod}$
SWD8.0X90	69	5,9	$14.59 + 13.99 / k_{mod}$
SWD8.0X130	97	5,9	$14.59 + 13.99 / k_{mod}$
SWD8.0X160	118	9,6	$14.59 + 13.99 / k_{mod}$
SWD8.0X190	139	11,9	$14.59 + 13.99 / k_{mod}$
SWD8.0X220	161	14,1	$14.59 + 13.99 / k_{mod}$
SWD8.0X245	178	15,9	$14.59 + 13.99 / k_{mod}$
SWD8.0X275	199	15,9	$14.59 + 13.99 / k_{mod}$
SWD8.0X300	217	20,0	$14.59 + 13.99 / k_{mod}$
SWD8.0X330	238	20,0	$14.59 + 13.99 / k_{mod}$

For dimensions and calculation parameters see p. 50.

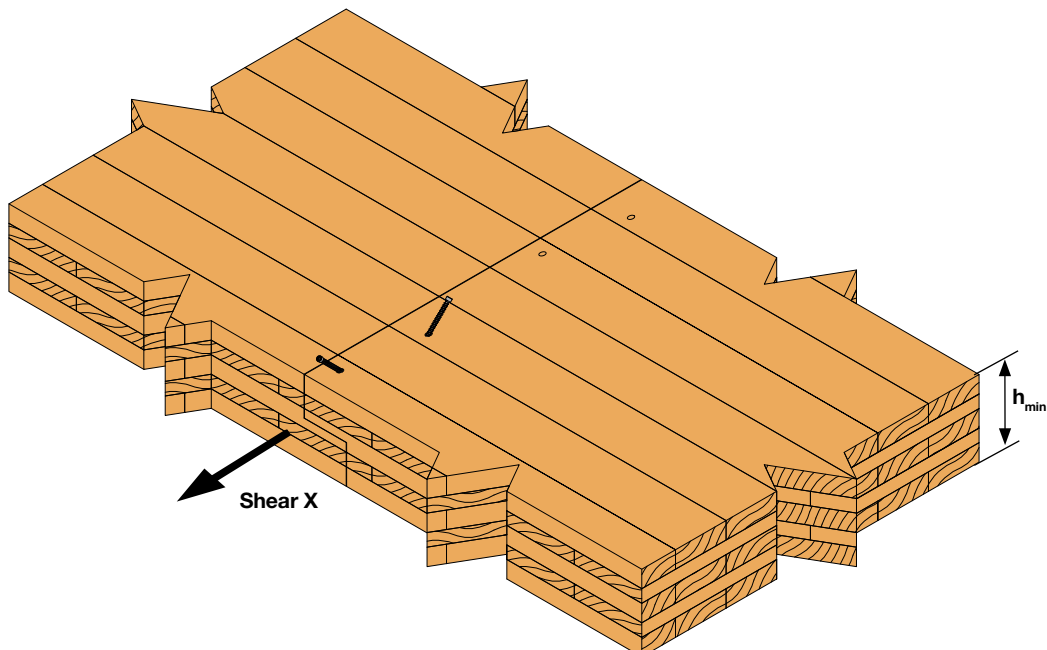

### 3.3.3 CLT Half-Lap Connection

## Solid-Drive™ ESCRFTZ Full Threaded WOOD Screw for Half-Lap CLT Connection

Yellow Zinc Plated  
C2 acc. to EN ISO 12944-2  
SC2 - 50 years acc. to EC5



ETA-13/0796

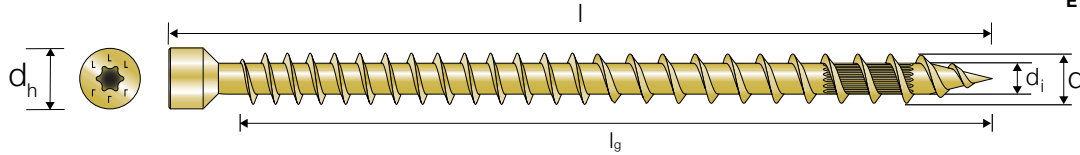

ESCRFTZ - Half-Lap Connection - Per Pair  $R_{v,k}$  [kN] =  $\min(R_{w,k, pair}; R_{buck,k, pair})$  - 45° Cross Pairs  
CLT to CLT  $\rho_k = 350 \text{ kg/m}^3$

Product Reference	Minimum Thickness of the Panel	Shear (X) Characteristic Capacity per Pair $R_{v,k}$ [kN] - Cross Pairs of Screws	
	$h_{min}$	$R_{w,k, pair}$	$R_{buck,k, pair}$
ESCRFTZ8.0X120	90	7,4	$14.59 + 13.99 / k_{mod}$
ESCRFTZ8.0X140	104	8,9	$14.59 + 13.99 / k_{mod}$
ESCRFTZ8.0X160	118	10,4	$14.59 + 13.99 / k_{mod}$
ESCRFTZ8.0X180	132	11,9	$14.59 + 13.99 / k_{mod}$
ESCRFTZ8.0X200	146	13,3	$14.59 + 13.99 / k_{mod}$
ESCRFTZ8.0X220	161	14,8	$14.59 + 13.99 / k_{mod}$
ESCRFTZ8.0X240	175	16,3	$14.59 + 13.99 / k_{mod}$
ESCRFTZ8.0X260	189	17,8	$14.59 + 13.99 / k_{mod}$
ESCRFTZ8.0X280	203	19,3	$14.59 + 13.99 / k_{mod}$
ESCRFTZ8.0X300	217	20,7	$14.59 + 13.99 / k_{mod}$
ESCRFTZ8.0X350	252	24,5	$14.59 + 13.99 / k_{mod}$
ESCRFTZ8.0X400	288	28,2	$14.59 + 13.99 / k_{mod}$

For dimensions and calculation parameters see p. 58.

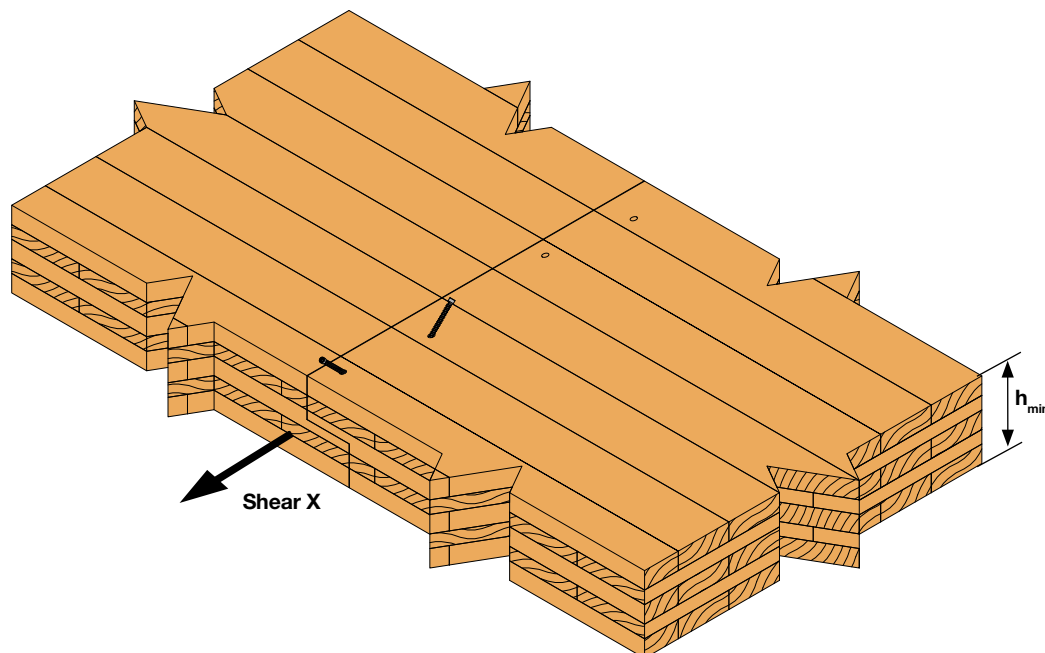

### 3.3.3 CLT Half-Lap Connection

## Solid-Drive™ ESCRFT Full Thread WOOD Screw for Half-Lap CLT Connection

Yellow Zinc Plated  
C2 acc. to EN ISO 12944-2  
SC2 - 50 years acc. to EC5

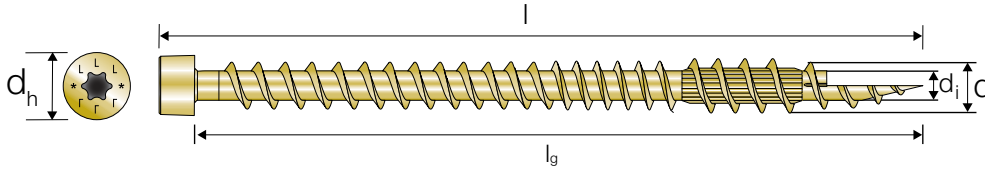

ESCRFT - Half-Lap Connection - Per Pair  $R_{v,k}$  [kN] =  $\min (R_{w,k, pair}; R_{buck,k, pair})$  - 45° Cross Pairs  
CLT to CLT  $\rho_k = 350 \text{ kg/m}^3$

Product Reference	Minimum Thickness of the Panel	Shear (X) Characteristic Capacity per Pair $R_{v,k}$ [kN] - Cross Pairs of Screws	
	$h_{min}$	$R_{w,k, pair}$	$R_{buck,k, pair}$
ESCRFT8.0X450	323	29,2	$14.59 + 13.99 / k_{mod}$
ESCRFT8.0X500	359	32,9	$14.59 + 13.99 / k_{mod}$
ESCRFT8.0X600	429	34,1	$14.59 + 13.99 / k_{mod}$
ESCRFT10.0X450	323	34,3	$14.59 + 13.99 / k_{mod}$
ESCRFT10.0X500	359	38,7	$14.59 + 13.99 / k_{mod}$
ESCRFT10.0X600	429	47,6	$14.59 + 13.99 / k_{mod}$
ESCRFT10.0X800	571	56,6	$14.59 + 13.99 / k_{mod}$
ESCRFT10.0X1000	711	56,6	$14.59 + 13.99 / k_{mod}$

For dimensions and calculation parameters see p. 60.

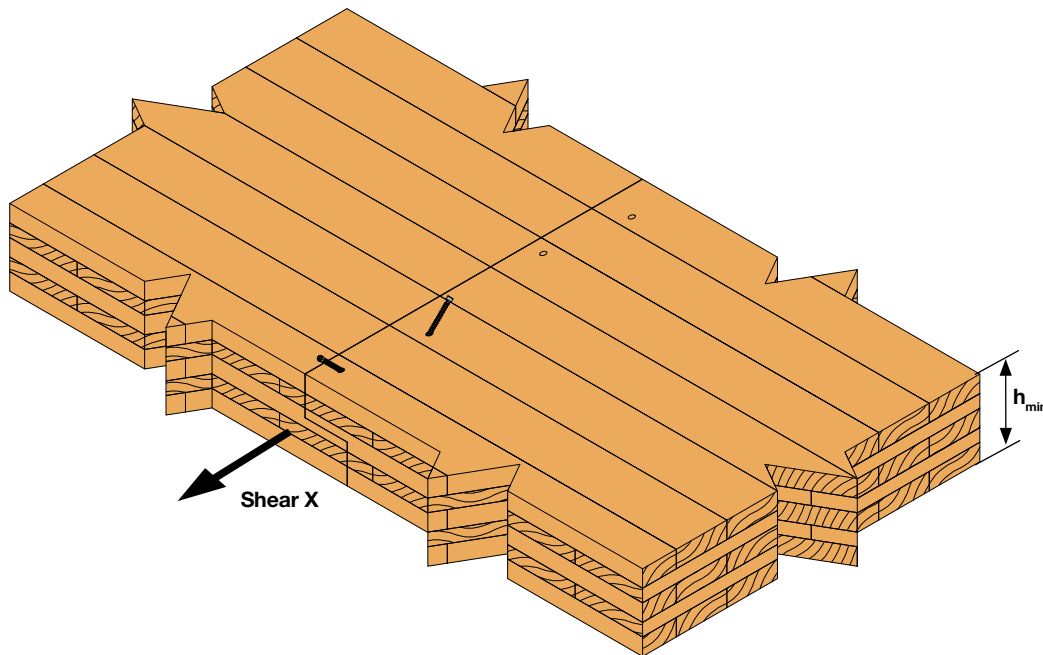

### 3.3.3 CLT Half-Lap Connection

#### Minimum Distances for Screws Half-Lap Connection - 45° Cross Pairs

##### SWD

Product Reference	$a_{1,red}$	$a_{3,c}$
6.5xℓ	10	39
8.0xℓ	12	48

##### ESCRFTZ/ESCRFT

Product Reference	$a_{1,red}$	$a_{3,c}$
8.0xℓ	12	48
10.0xℓ	15	60

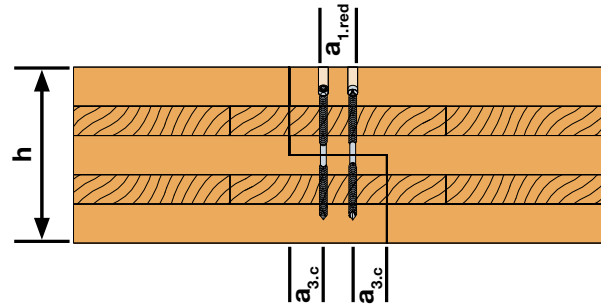

### 3.3.4 CLT Butt-Joint Connection

## Solid-Drive™ SWD Double Threaded WOOD Screw for Butt-Joint CLT Connection

Protec® +

C3 acc. to EN ISO 12944-2  
SC2 - 50 years acc. to EC5

UK  
CA



ETA-21/0670

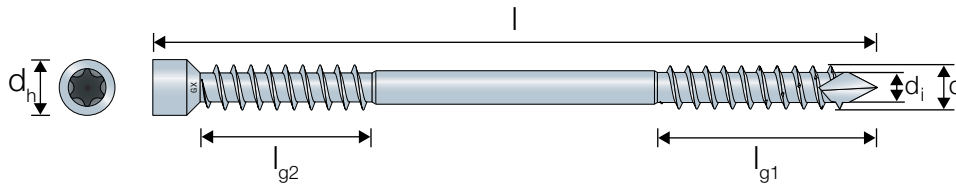

SWD - Butt-Joint Connection - Per Pair  $R_{v,k}$  [kN] =  $\min(R_{w,k, pair}; R_{buck,k, pair})$  - 45° Cross Pair  
CLT to CLT  $\rho_k = 350 \text{ kg/m}^3$

Product Reference	Panel Thickness Min. Height $h_{min}$ [mm]	Shear Characteristic Capacity per Pair $R_{v,k}$ [kN] - Cross Pairs of Screws	
		$R_{v,k, pair}$ [kN] = $\min(R_{ax,k}; R_{buck,k})$	
		$R_{w,k, pair}$ (Tension)	$R_{buck,k, pair}$ (Compression)
SWD6.5X90	69	2,8	$1.39 + 5.51 / k_{mod}$
SWD6.5X130	97	2,8	$1.39 + 5.51 / k_{mod}$
SWD6.5X160	118	4,9	$2.43 + 5.51 / k_{mod}$
SWD6.5X190	139	6,1	$3.05 + 5.51 / k_{mod}$
SWD6.5X220	161	7,4	$3.67 + 5.51 / k_{mod}$
SWD8.0X90	69	3,1	$1.54 + 10.22 / k_{mod}$
SWD8.0X130	97	3,1	$1.54 + 10.22 / k_{mod}$
SWD8.0X160	118	5,5	$2.76 + 10.22 / k_{mod}$
SWD8.0X190	139	7,0	$3.49 + 10.22 / k_{mod}$
SWD8.0X220	161	8,5	$4.22 + 10.22 / k_{mod}$
SWD8.0X245	178	9,7	$4.84 + 10.22 / k_{mod}$
SWD8.0X275	199	9,7	$4.84 + 10.22 / k_{mod}$
SWD8.0X300	217	12,4	$6.18 + 10.22 / k_{mod}$
SWD8.0X330	238	12,4	$6.18 + 10.22 / k_{mod}$

For dimensions and calculation parameters see p. 50.

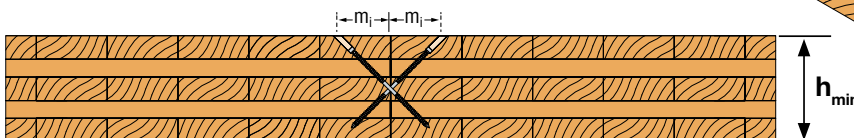
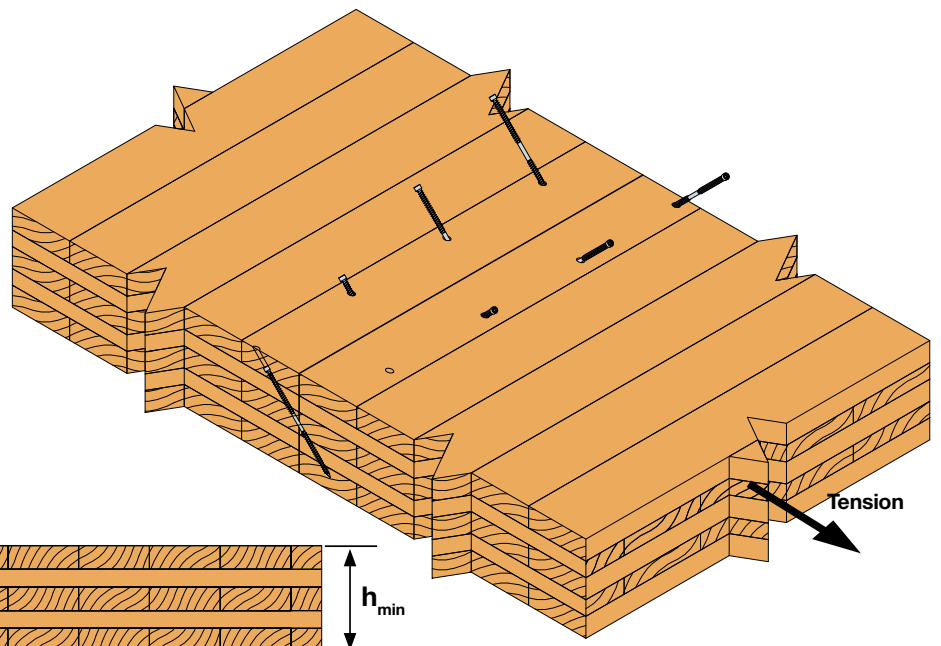

For explanation of  $m_1$  see page 26.



### 3.3.4 CLT Butt-Joint Connection

## Solid-Drive™ ESCRFTZ Full Threaded WOOD Screw for Butt-Joint CLT Connection

Yellow Zinc Plated  
C2 acc. to EN ISO 12944-2  
SC2 - 50 years acc. to EC5

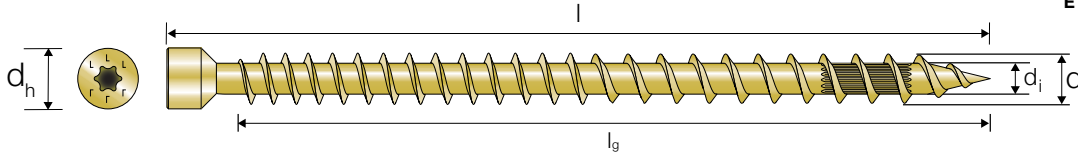

ESCRFTZ - Butt-Joint Connection - Per Pair  $R_{v,k} [kN] = \min (R_{w,k, pair}; R_{buck,k, pair})$  - 45° Cross Pair  
CLT to CLT  $\rho_k = 350 \text{ kg/m}^3$

Product Reference	Panel Thickness Min. Height $h_{min}$ [mm]	Shear Characteristic Capacity per Pair $R_{v,k} [kN]$ - Cross Pairs of Screws	
		$R_{v,k, pair} [kN] = \min(R_{ax,k}; R_{buck,k})$	
		$R_{w,k, pair}$ (Tension)	$R_{buck,k, pair}$ (Compression)
ESCRFTZ8.0X120	90	4,4	$2.2 + 9.23 / k_{mod}$
ESCRFTZ8.0X140	104	5,4	$2.68 + 9.23 / k_{mod}$
ESCRFTZ8.0X160	118	6,4	$3.17 + 9.23 / k_{mod}$
ESCRFTZ8.0X180	132	7,3	$3.66 + 9.23 / k_{mod}$
ESCRFTZ8.0X200	146	8,3	$4.15 + 9.23 / k_{mod}$
ESCRFTZ8.0X220	161	9,3	$4.64 + 9.23 / k_{mod}$
ESCRFTZ8.0X240	175	10,3	$5.13 + 9.23 / k_{mod}$
ESCRFTZ8.0X260	189	11,2	$5.62 + 9.23 / k_{mod}$
ESCRFTZ8.0X280	203	12,2	$6.11 + 9.23 / k_{mod}$
ESCRFTZ8.0X300	217	13,2	$6.6 + 9.23 / k_{mod}$
ESCRFTZ8.0X350	252	15,6	$7.82 + 9.23 / k_{mod}$
ESCRFTZ8.0X400	288	18,1	$9.04 + 9.23 / k_{mod}$

For dimensions and calculation parameters see p. 58.

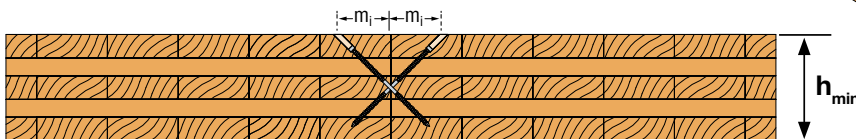
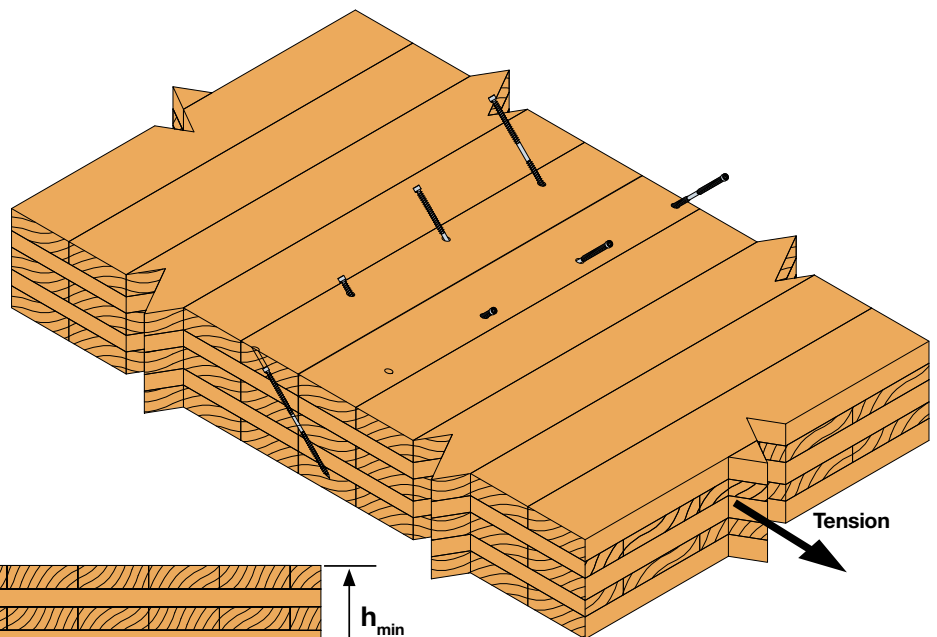

For explanation of  $m_1$  see page 26.

### 3.3.4 CLT Butt-Joint Connection

## Solid-Drive™ ESCRFT Full Threaded WOOD Screw for Butt-Joint CLT Connection

Yellow Zinc Plated  
C2 acc. to EN ISO 12944-2  
SC2 - 50 years acc. to EC5



ETA-13/0796

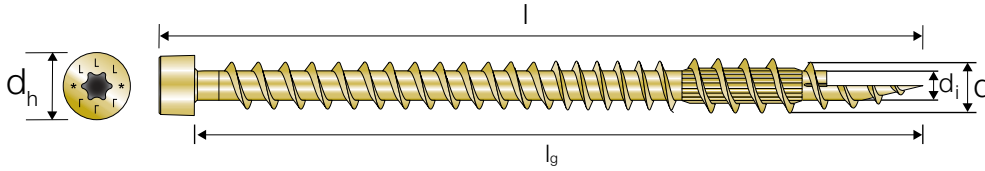

ESCRFT - Butt-Joint Connection - Per Pair  $R_{v,k}$  [kN] =  $\min(R_{w,k, pair}; R_{buck,k, pair})$  - 45° Cross Pair  
CLT to CLT  $\rho_k = 350 \text{ kg/m}^3$

Product Reference	Panel Thickness Min. Height $h_{min}$ [mm]	Shear Characteristic Capacity per Pair $R_{v,k}$ [kN] - Cross Pairs of Screws	
		$R_{v,k, pair}$ [kN] = $\min(R_{ax,k}; R_{buck,k})$	
		$R_{w,k, pair}$ (Tension)	$R_{buck,k, pair}$ (Compression)
ESCRFT10.0x450	323	22,0	$11.02 + 12.95 / k_{mod}$
ESCRFT10.0x500	359	25,0	$12.47 + 12.95 / k_{mod}$

For dimensions and calculation parameters see p. 60.

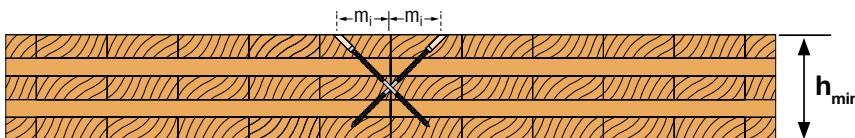
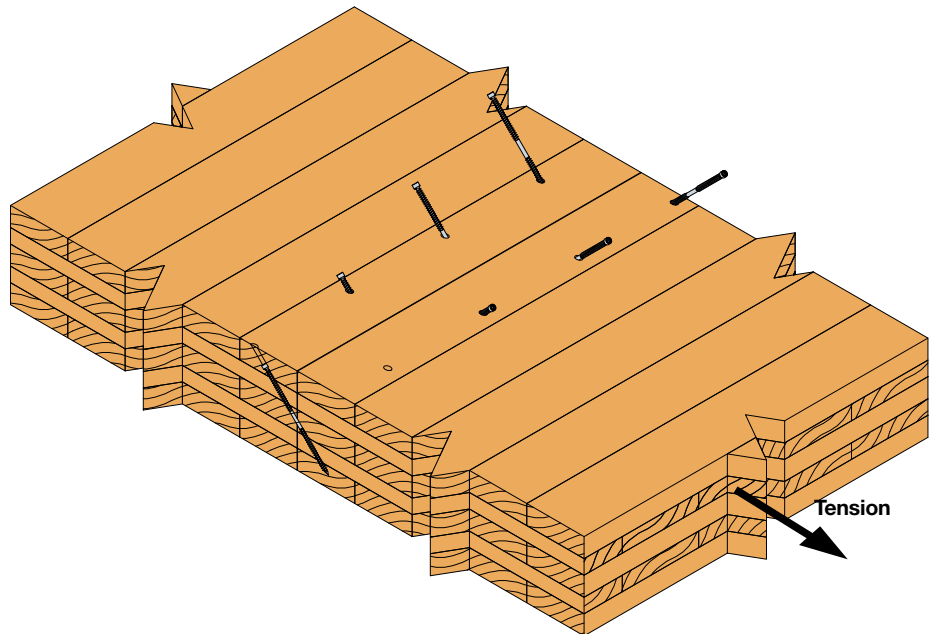

For explanation of  $m_1$  see page 26.

### 3.3.4 CLT Butt-Joint Connection

## Solid-Drive™ SWD Double Threaded WOOD Screw for Butt-Joint CLT Connection

Protec® +  
C3 acc. to EN ISO 12944-2  
SC2 - 50 years acc. to EC5

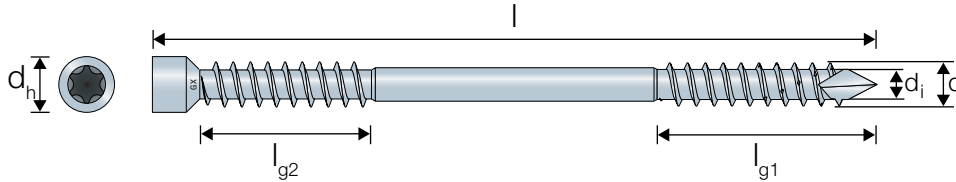

SWD - Butt-Joint Connection with Angled Cross Pairs - Per Pair  $R_{v,k} [kN] = \min(R_{w,k, pair}; R_{buck,k, pair})$   
CLT to CLT  $\rho_k = 350 \text{ kg/m}^3$

Product Reference	Panel Thickness Min. Height $h_{min}$ [mm]	Characteristic capacity (Shear X = Shear Z = Tension) - CLT	
		$R_{v,k, pair} [kN] = \min(R_{ax,k}; R_{buck,k})$	
		$R_{w,k, pair}$ (Tension)	$R_{buck,k, pair}$ (Compression)
SWD6.5x90	104	3,94	$1.96 + 5.51 / k_{mod}$
SWD6.5x130	104	3,94	$1.96 + 5.51 / k_{mod}$
SWD6.5x160	126	6,87	$3.43 + 5.51 / k_{mod}$
SWD6.5x190	147	8,64	$4.31 + 5.51 / k_{mod}$
SWD6.5x220	168	10,40	$5.19 + 5.51 / k_{mod}$
SWD8x90	128	4,36	$2.17 + 10.22 / k_{mod}$
SWD8x130	128	4,36	$2.17 + 10.22 / k_{mod}$
SWD8x160	128	7,81	$3.9 + 10.22 / k_{mod}$
SWD8x190	147	9,89	$4.94 + 10.22 / k_{mod}$
SWD8x220	168	11,96	$5.98 + 10.22 / k_{mod}$
SWD8x245	186	13,69	$6.84 + 10.22 / k_{mod}$
SWD8x275	207	13,69	$6.84 + 10.22 / k_{mod}$
SWD8x300	225	17,49	$8.74 + 10.22 / k_{mod}$
SWD8x330	246	17,49	$8.74 + 10.22 / k_{mod}$

For dimensions and calculation parameters see p. 50.

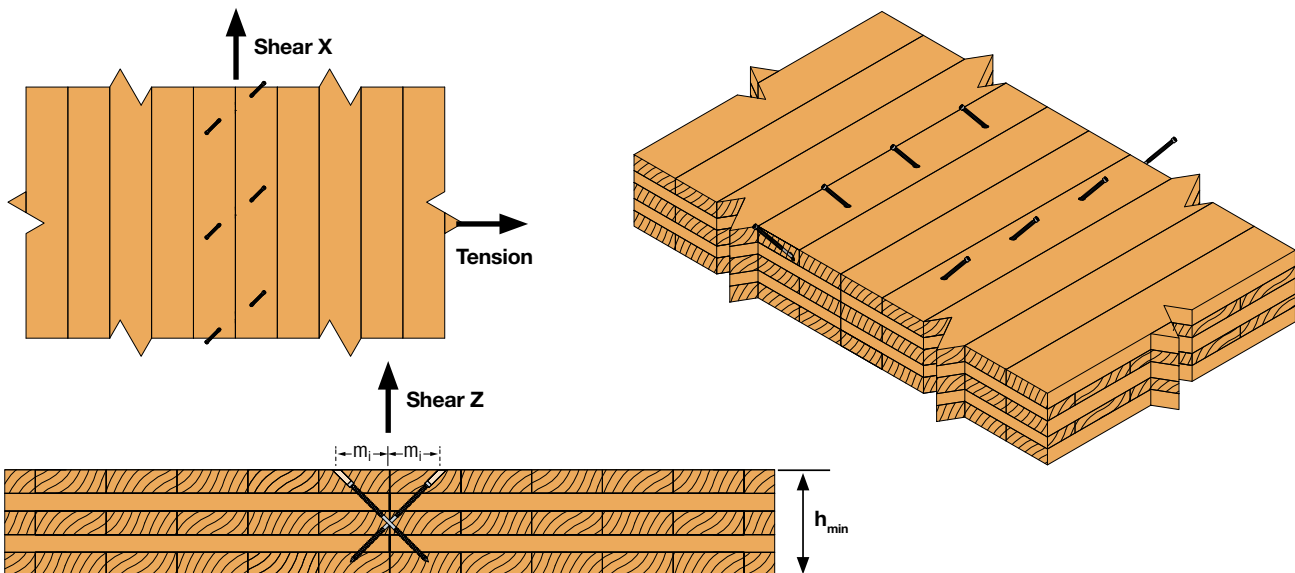

For explanation of  $m_i$  see page 26.

### 3.3.4 CLT Butt-Joint Connection

## Solid-Drive™ ESCRFTZ Full Threaded WOOD Screw for Butt-Joint CLT Connection

Yellow Zinc Plated  
C2 acc. to EN ISO 12944-2  
SC2 - 50 years acc. to EC5



ETA-13/0796

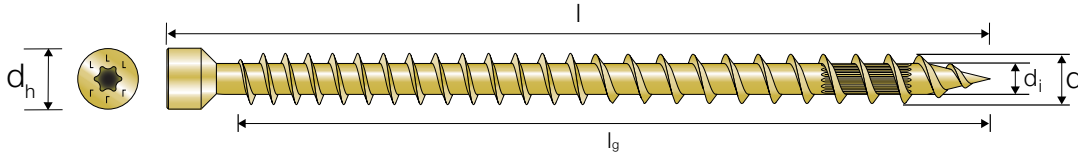

ESCRFTZ - Butt-Joint Connection with Angled Cross Pairs - Per Pair  $R_{v,k}$  [kN] =  $\min(R_{w,k, pair}; R_{buck,k, pair})$   
CLT to CLT  $\rho_k = 350 \text{ kg/m}^3$

Product Reference	Panel Thickness Min. Height $h_{min}$ [mm]	Characteristic capacity (Shear X = Shear Z = Tension) - CLT	
		$R_{v,k, pair}$ [kN] = $\min(R_{ax,k}; R_{buck,k})$	
		$R_{w,k, pair}$ (Tension)	$R_{buck,k, pair}$ (Compression)
ESCRFTZ8.0X120	128	6,22	$3.11 + 9.23 / k_{mod}$
ESCRFTZ8.0X140	128	7,61	$3.8 + 9.23 / k_{mod}$
ESCRFTZ8.0X160	128	8,99	$4.49 + 9.23 / k_{mod}$
ESCRFTZ8.0X180	140	10,37	$5.18 + 9.23 / k_{mod}$
ESCRFTZ8.0X200	154	11,75	$5.87 + 9.23 / k_{mod}$
ESCRFTZ8.0X220	168	13,14	$6.56 + 9.23 / k_{mod}$
ESCRFTZ8.0X240	182	14,52	$7.25 + 9.23 / k_{mod}$
ESCRFTZ8.0X260	196	15,90	$7.95 + 9.23 / k_{mod}$
ESCRFTZ8.0X280	210	17,29	$8.64 + 9.23 / k_{mod}$
ESCRFTZ8.0X300	225	18,67	$9.33 + 9.23 / k_{mod}$
ESCRFTZ8.0X350	260	22,13	$11.06 + 9.23 / k_{mod}$
ESCRFTZ8.0X400	295	25,58	$12.79 + 9.23 / k_{mod}$

For dimensions and calculation parameters see p. 58.

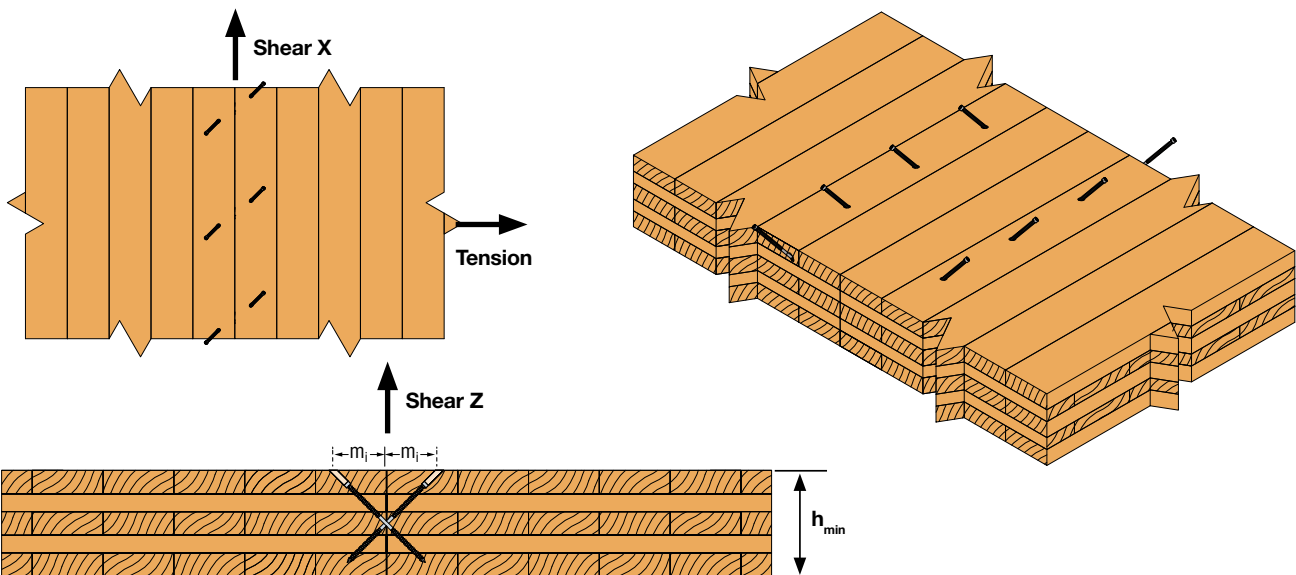

For explanation of  $m_1$  see page 26.

### 3.3.4 CLT Butt-Joint Connection

## Solid-Drive™ ESCRFT Full Threaded WOOD Screw for Butt-Joint CLT Connection

Yellow Zinc Plated  
C2 acc. to EN ISO 12944-2  
SC2 - 50 years acc. to EC5

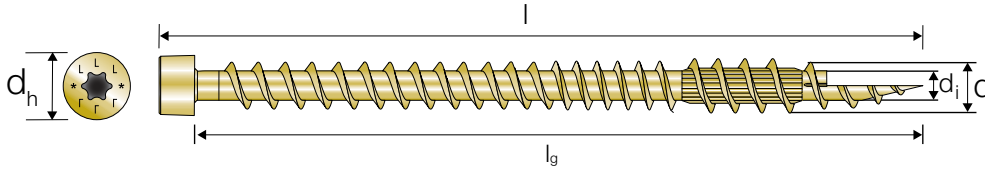

ESCRFTZ - Butt-Joint Connection with Angled Cross Pairs - Per Pair  $R_{v,k}$  [kN] =  $\min(R_{w,k, pair}; R_{buck,k, pair})$   
CLT to CLT  $\rho_k = 350 \text{ kg/m}^3$

Product Reference	Panel Thickness Min. Height $h_{min}$ [mm]	Characteristic capacity (Shear X = Shear Z = Tension) - CLT	
		$R_{v,k, pair}$ [kN] = $\min(R_{ax,k}; R_{buck,k})$	
		$R_{w,k, pair}$ (Tension)	$R_{buck,k, pair}$ (Compression)
ESCRFT10.0x450	331	31,17	$15.58 + 12.95 / k_{mod}$

For dimensions and calculation parameters see p. 60.

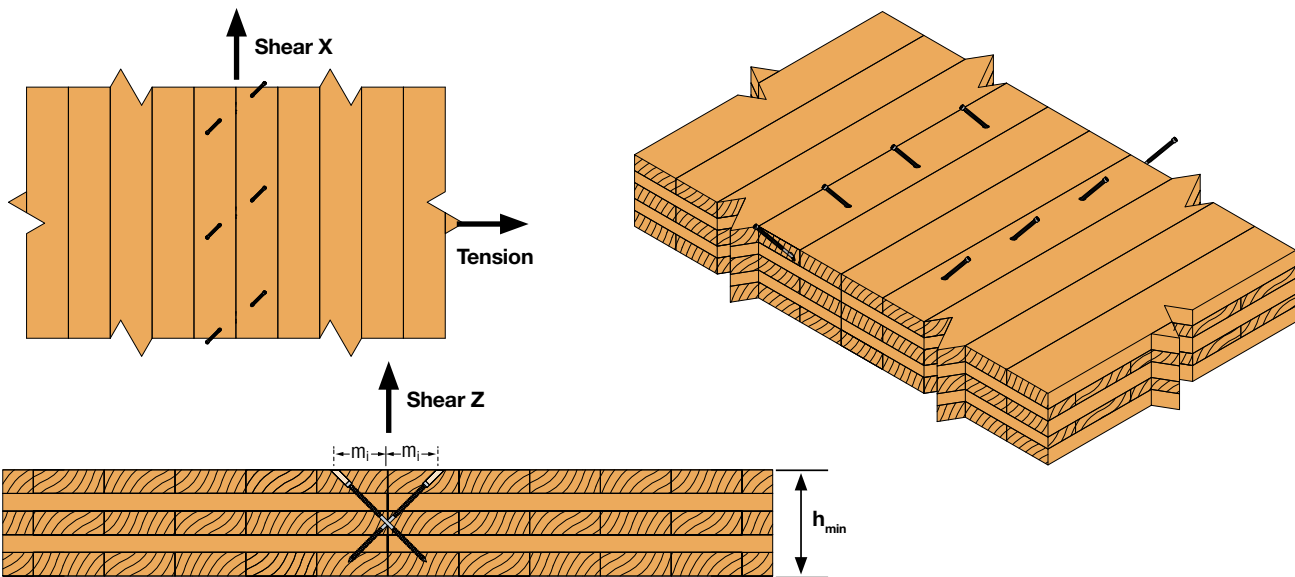

For explanation of  $m_i$  see page 26.

### 3.3.5 CLT Spline Connection

## Solid-Drive™ TTUFS Structural Countersunk WOOD Screw for CLT Spline Connection

Electro Galvanised  
C1 acc. to EN ISO 12944-2  
SC2 - 50 years acc. to EC5

UK  
CA



ETA-21/0670

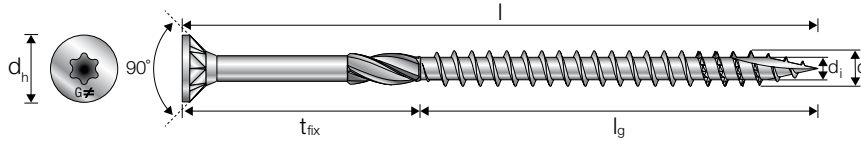

TTUFS - CLT Spline Connection  
Plywood Board  $\rho_k = 490 \text{ kg/m}^3$  to CLT  $\rho_k = 350 \text{ kg/m}^3$

Product Reference	Characteristic Shear (X or Y) Capacity for Plywood ( $\rho_k \geq 490 \text{ kg/m}^3$ ) to CLT ( $\rho_k \geq 350 \text{ kg/m}^3$ ) Connection Depending of the Thickness of the Panel $t_p$				
	15	18	22	25	30
	$R_{v,90,k.15}$	$R_{v,90,k.18}$	$R_{v,90,k.22}$	$R_{v,90,k.25}$	$R_{v,90,k.30}$
TTUFS4.5X40	0,97	-	-	-	-
TTUFS4.5X45	1,01	1,07	-	-	-
TTUFS4.5X50	1,01	1,08	1,41	1,37	-
TTUFS4.5X60	1,01	1,08	1,44	1,44	1,44
TTUFS4.5X70	1,01	1,08	1,44	1,46	1,46
TTUFS4.5X80	1,01	1,08	1,44	1,51	1,51
TTUFS5.0X40	1,08	-	-	-	-
TTUFS5.0X50	1,20	1,28	1,59	1,56	-
TTUFS5.0X60	1,20	1,28	1,69	1,78	1,74
TTUFS5.0X70	1,20	1,28	1,69	1,78	1,93
TTUFS5.0X80	1,20	1,28	1,69	1,78	1,93
TTUFS5.0X90	1,20	1,28	1,69	1,78	1,95
TTUFS5.0X100	1,20	1,28	1,69	1,78	1,95
TTUFS5.0X120	1,20	1,28	1,69	1,78	1,95

Table continues on next page.

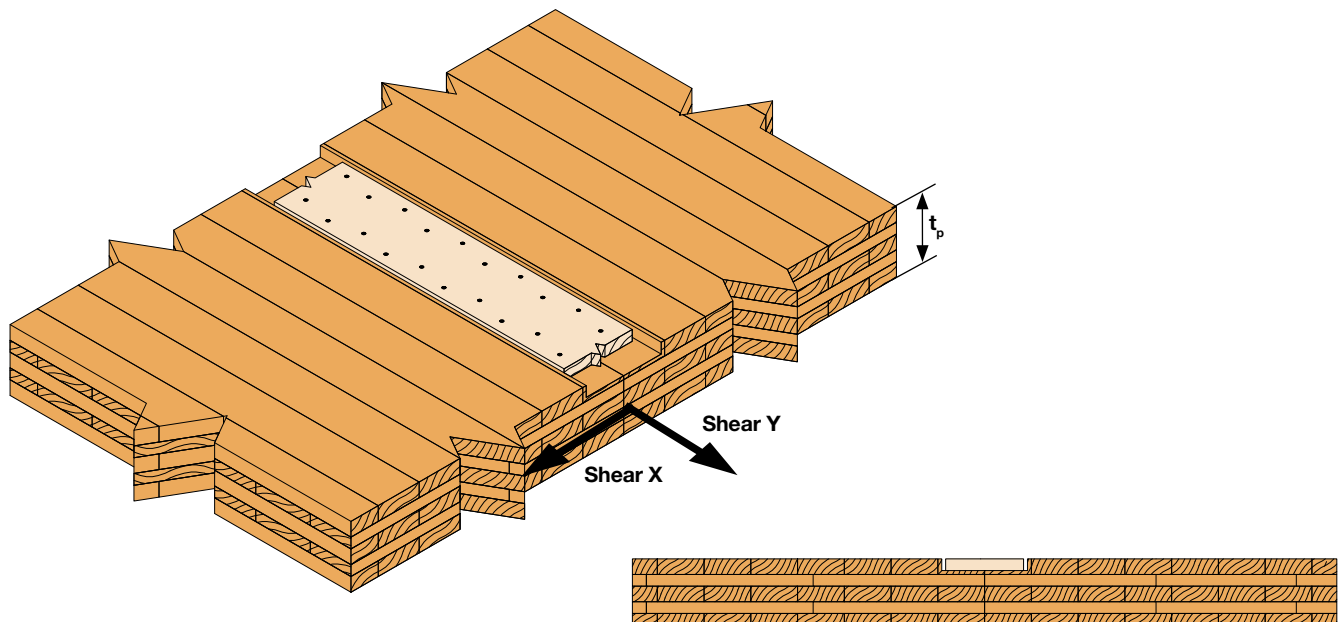

### 3.3.5 CLT Spline Connection

TTUFS - CLT Spline Connection

Plywood Board  $\rho_k = 490 \text{ kg/m}^3$  to

CLT  $\rho_k = 350 \text{ kg/m}^3$  (cont)

Product Reference	Characteristic Shear (X or Y) Capacity for Plywood ( $\rho_k \geq 490 \text{ kg/m}^3$ ) to CLT ( $\rho_k \geq 350 \text{ kg/m}^3$ ) Connection Depending of the Thickness of the Panel $t_p$				
	15	18	22	25	30
	$R_{v,90,k,15}$	$R_{v,90,k,18}$	$R_{v,90,k,22}$	$R_{v,90,k,25}$	$R_{v,90,k,30}$
TTUFS6.0X40	1,31	-	-	-	-
TTUFS6.0X50	1,53	1,56	1,74	1,71	-
TTUFS6.0X60	1,53	1,61	2,05	2,11	2,01
TTUFS6.0X70	1,53	1,61	2,15	2,25	2,43
TTUFS6.0X80	1,53	1,61	2,15	2,25	2,43
TTUFS6.0X90	1,53	1,61	2,17	2,27	2,45
TTUFS6.0X100	1,53	1,61	2,17	2,27	2,45
TTUFS6.0X120	1,53	1,61	2,17	2,27	2,45
TTUFS6.0X140	1,53	1,61	2,17	2,27	2,45
TTUFS6.0X160	1,53	1,61	2,17	2,27	2,45
TTUFS6.0X180	1,53	1,61	2,17	2,27	2,45

For dimensions and calculation parameters see p. 40.

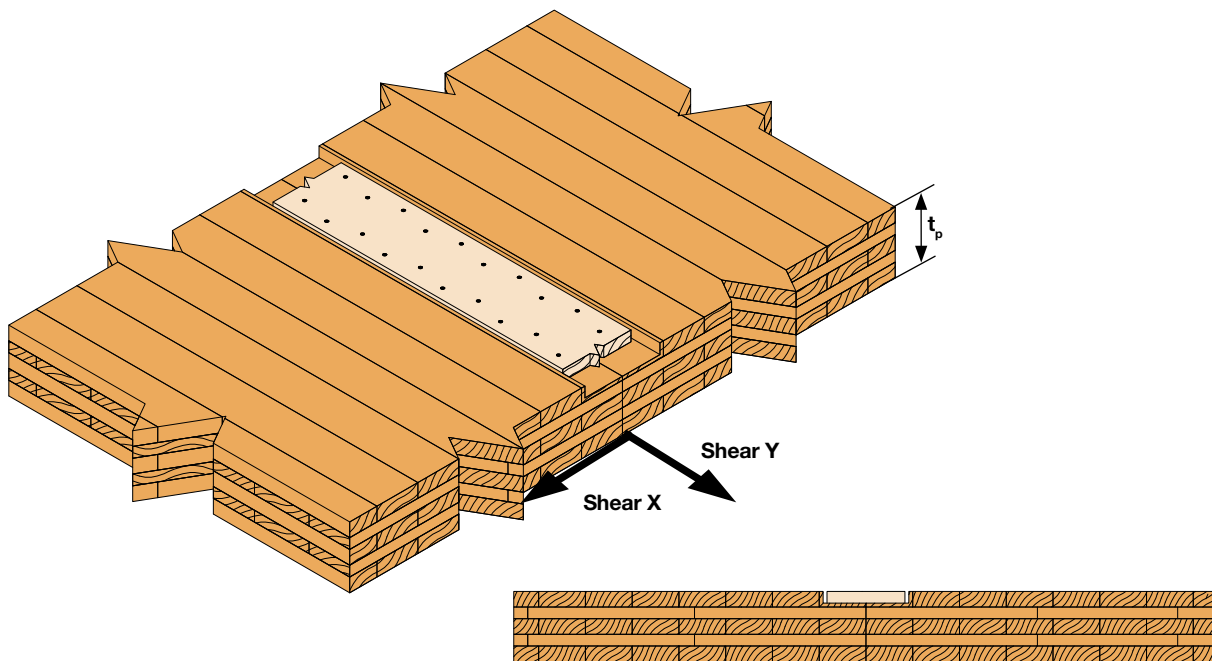



### 3.3.5 CLT Spline Connection

## Solid-Drive™ WSV Collated Countersunk WOOD Screw for CLT Spline Connection

Yellow Zinc Plated  
C2 acc. to EN ISO 12944-2  
SC2 - 50 years acc. to EC5

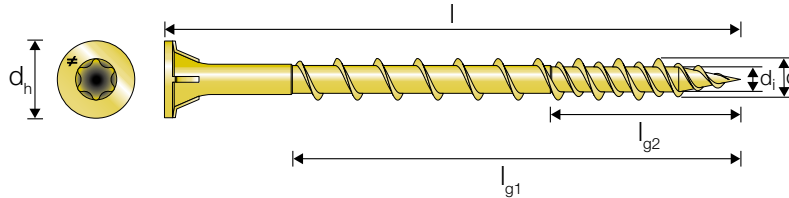

WSV - CLT Spline Connection  
Plywood Board  $\rho_k = 490 \text{ kg/m}^3$  to CLT  $\rho_k = 350 \text{ kg/m}^3$

Product Reference	Characteristic Shear (X or Y) Capacity for Plywood ( $\rho_k \geq 490 \text{ kg/m}^3$ ) to CLT ( $\rho_k \geq 350 \text{ kg/m}^3$ ) Connection Depending of the Thickness of the Panel $t_p$				
	15	18	22	25	30
	$R_{v,90,k.15}$	$R_{v,90,k.18}$	$R_{v,90,k.22}$	$R_{v,90,k.25}$	$R_{v,90,k.30}$
WSV44E (4.6x44)	0,78	0,82	0,75	0,69	-
WSV51E (4.6x51)	0,78	0,87	0,89	0,83	0,73
WSV64E (4.6x64)	1,20	1,20	1,00	1,10	1,00
WSV76E (4.6x76)	1,23	1,23	1,23	1,23	1,23

For dimensions and calculation parameters see p. 68.

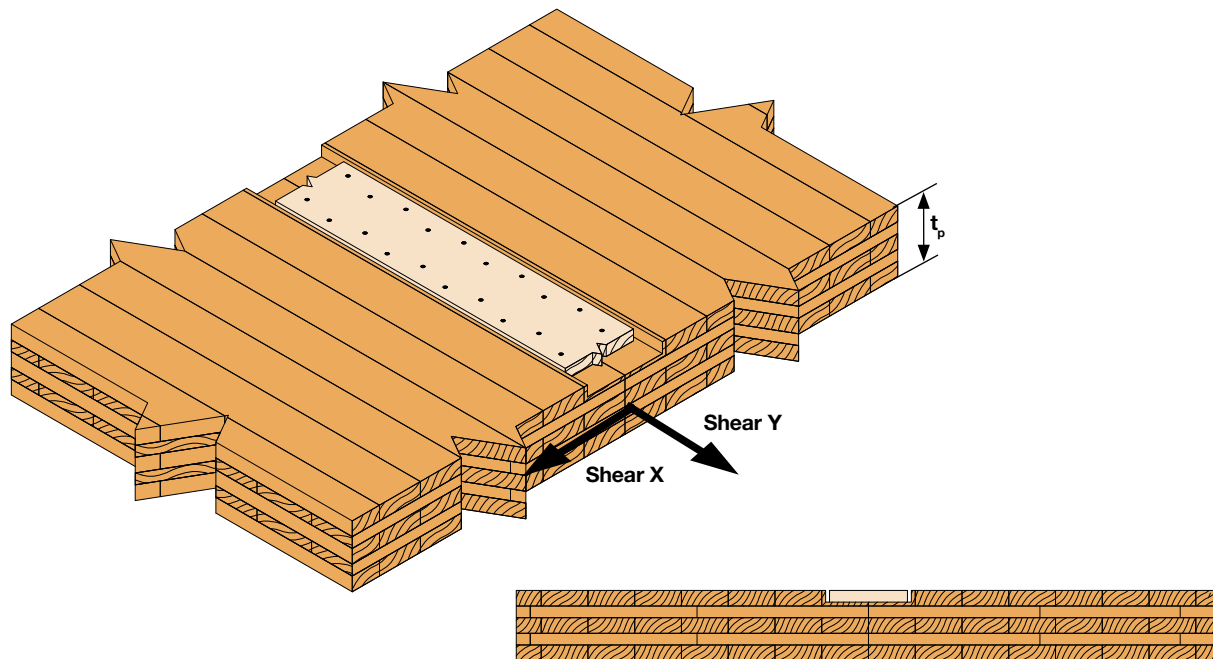

### 3.3.5 CLT Spline Connection

#### Minimum Distances for Screws CLT Spline Connection

##### TTUFS

Dimension	Angle Between the Load and the Grain 0°			
	$a_1$	$a_2$	$a_{3,c}$	$a_{3,cp}$
4.5xℓ	18	18	28	14
5.0xℓ	20	20	30	15
6.0xℓ	24	24	36	18

##### WSV

Dimension	Angle Between the Load and the Grain 0°			
	$a_1$	$a_2$	$a_{3,c}$	$a_{3,cp}$
4.6xℓ	18	18	28	14

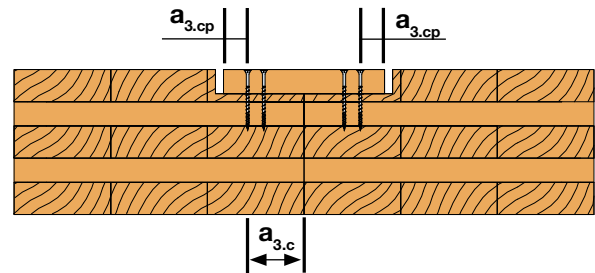



## Calculating fasteners for wood has never been easier

In just four simple steps, Solid Wood helps you calculate and select fastening solutions suitable for the specific wood structure at hand, according to Eurocode 5 and our ETA.

- **Time saving** - Quicker and easier than manual calculations
- **Safety** - Removes any doubt in the precision of your manual calculations
- **Product guide** - Helps you find the correct product for your application

The software generates a PDF-report that can be used as documentation for the project.

[solidwood.strongtie.eu](http://solidwood.strongtie.eu)



Calculation in four simple steps.

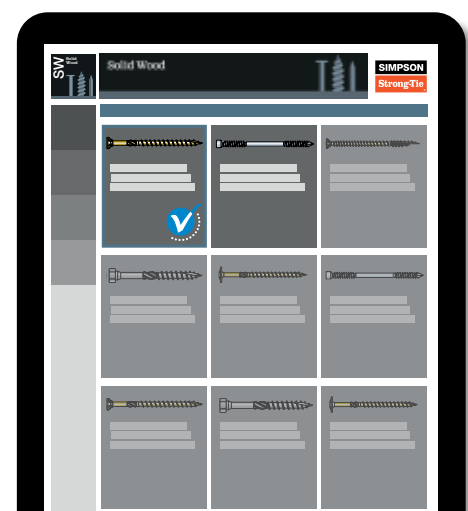



Solid-Drive™ SSH Connector Screw

**We help you build safer,  
stronger structures.**



The logo consists of the word "SIMPSON" in white, uppercase letters on a black rectangular background.The logo consists of the words "Strong-Tie" in white, with "Strong" and "Tie" in a sans-serif font and "Tie" in a script font, on a red rectangular background.The title "Steel to Timber Fastening" is written in a large, white, sans-serif font against a solid blue background. The background of the entire page features a photograph of a building's exterior with light-colored horizontal siding and a window frame, with a circular inset showing a close-up of wood grain.

**Steel to Timber Fastening**

SSH .....	230
SSF .....	234
CSA .....	236
CSA-Z .....	237
CSA-S .....	237
CNA .....	239
CNA-G .....	240
CNA-S .....	240
TTUFS .....	242
TTZNFS .....	244
TTSFS .....	246
SWC .....	248
ESCRFTC .....	251

## 4. Steel to Timber Fastening

# Solid-Drive™ SSH Structural Hex-Head CONNECTOR Screw for Steel to Timber

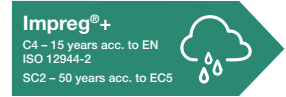

ETA-21/0670

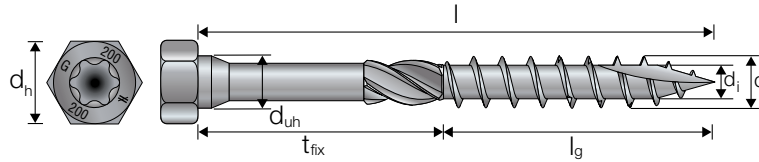

### SSH – Characteristic Capacity Steel to Timber C24

Product Reference	Tension Capacity - C24 – $R_{ax,k}$ [kN] <sup>1)</sup>	Shear Capacity – C24 – [kN]					
		Thin Steel <sup>2)</sup>			Thick Steel <sup>3)</sup>		
		Maximum Thickness [mm]	$R_{v,0^\circ,k}$	$R_{v,90^\circ,k}$	Minimum Thickness [mm]	$R_{v,0^\circ,k}$	$R_{v,90^\circ,k}$
SSH6.0x40 <sup>4)</sup>	1,8	3,0	2,40	2,40	6,0	3,16	3,16
			1,49	1,49			2,29
SSH6.0x50 <sup>4)</sup>	2,6	3,0	2,77	2,77	6,0	3,64	3,64
			1,89	1,89			2,82
SSH6.0x60 <sup>4)</sup>	3,4	3,0	2,95	2,95	6,0	3,82	3,82
			2,29	2,29			3,19
SSH6.0x75 <sup>4)</sup>	3,4	3,0	2,95	2,95	6,0	3,82	3,82
			2,50	2,50			3,19
SSH6.0x90 <sup>4)</sup>	3,4	3,0	2,95	2,95	6,0	3,82	3,82
			2,50	2,50			3,19
SSH6.0x120 <sup>4)</sup>	6,0	3,0	3,61	3,61	6,0	4,48	4,48
			3,16	3,16			3,85

<sup>1)</sup> For steel thickness  $\leq d$

<sup>2)</sup> Thin plate: thickness  $\leq 0.5xd$

<sup>3)</sup> Thick plate: thickness  $\geq d$

<sup>4)</sup> 6.0mm screws have a different head design – see page 52.

For intermediate steel thicknesses, the strength can be obtained by interpolation.

For recommended hole diameter in steel see page 29.

Characteristic capacities	4,48	With pre-drill
	3,85	Without pre-drill

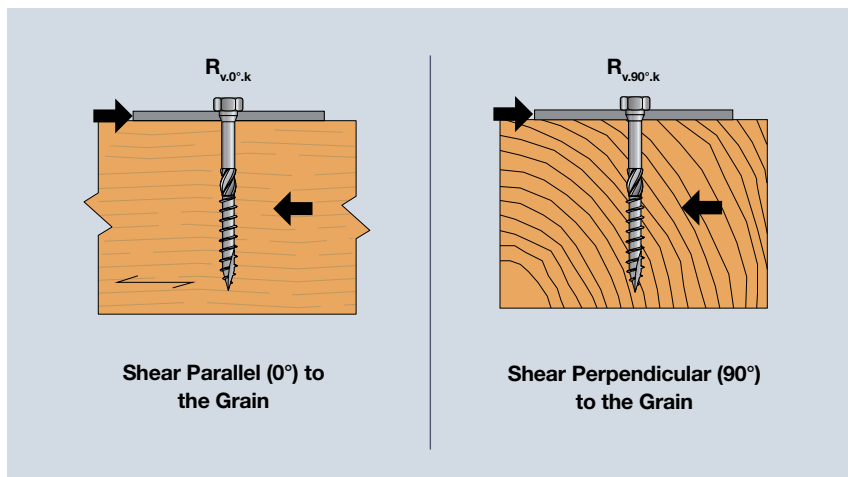

## 4. Steel to Timber Fastening

### SSH – Characteristic Capacity Steel to Timber C24 (cont.)

Product Reference	Tension Capacity – C24 – $R_{ax,k}$ [kN] <sup>1)</sup>	Shear Capacity – C24 – [kN]					
		Thin Steel <sup>2)</sup>			Thick Steel <sup>3)</sup>		
		Maximum Thickness [mm]	$R_{v,0^\circ,k}$	$R_{v,90^\circ,k}$	Minimum Thickness [mm]	$R_{v,0^\circ,k}$	$R_{v,90^\circ,k}$
SSH8.0X40	3,6	4,0	3,04	3,04	8,0	4,75	4,75
			1,77	1,77		3,54	3,54
SSH8.0X50	4,7	4,0	3,89	3,89	8,0	5,67	5,67
			2,26	2,26		4,12	4,12
SSH8.0x60	4,7	4,0	4,73	4,73	8,0	6,39	6,39
			2,76	2,76		4,48	4,48
SSH8.0x70	4,7	4,0	4,93	4,93	8,0	6,48	6,48
			3,25	3,25		4,89	4,89
SSH8.0X80	4,7	4,0	4,93	4,93	8,0	6,48	6,48
			3,74	3,74		5,23	5,23
SSH8.0X90	4,7	4,0	4,93	4,93	8,0	6,48	6,48
			4,04	4,04		5,23	5,23
SSH8.0X100	6,1	4,0	5,29	5,29	8,0	6,85	6,85
			4,40	4,40		5,59	5,59
SSH8.0X120	9,5	4,0	6,12	6,12	8,0	7,68	7,68
			5,23	5,23		6,42	6,42
SSH8.0X140	9,5	4,0	6,12	6,12	8,0	7,68	7,68
			5,23	5,23		6,42	6,42
SSH8.0X160	12,2	4,0	6,82	6,82	8,0	8,38	8,38
			5,74	5,74		7,12	7,12
SSH8.0X180	12,2	4,0	6,82	6,82	8,0	8,38	8,38
			5,74	5,74		7,12	7,12
SSH8.0X200	12,2	4,0	6,82	6,82	8,0	8,38	8,38
			5,74	5,74		7,12	7,12
SSH8.0X240	12,2	4,0	6,82	6,82	8,0	8,38	8,38
			5,74	5,74		7,12	7,12
SSH8.0X260	12,2	4,0	6,82	6,82	8,0	8,38	8,38
			5,74	5,74		7,12	7,12
SSH8.0X280	12,2	4,0	6,82	6,82	8,0	8,38	8,38
			5,74	5,74		7,12	7,12
SSH8.0X300	12,2	4,0	6,82	6,82	8,0	8,38	8,38
			5,74	5,74		7,12	7,12
SSH10.0X50	3,9	5,0	3,62	3,62	10,0	5,87	5,87
			2,59	2,59		4,92	4,92
SSH10.0X60	5,1	5,0	5,68	5,68	10,0	7,68	7,68
			3,16	3,16		5,29	5,29
SSH10.0X80	5,1	5,0	6,41	6,41	10,0	8,54	8,54
			4,32	4,32		6,20	6,20
SSH10.0X90	5,1	5,0	6,41	6,41	10,0	8,54	8,54
			4,89	4,89		6,70	6,70
SSH10.0X100	6,7	5,0	6,81	6,81	10,0	8,94	8,94
			5,47	5,47		7,09	7,09
SSH10.0X120	10,3	5,0	7,71	7,71	10,0	9,84	9,84
			6,41	6,41		8,00	8,00
SSH10.0X140	10,3	5,0	7,71	7,71	10,0	9,84	9,84
			6,41	6,41		8,00	8,00
SSH10.0X160	13,3	5,0	8,47	8,47	10,0	10,60	10,60
			7,16	7,16		8,75	8,75
SSH10.0X180	13,3	5,0	8,47	8,47	10,0	10,60	10,60
			7,16	7,16		8,75	8,75
SSH10.0X200	13,3	5,0	8,47	8,47	10,0	10,60	10,60
			7,16	7,16		8,75	8,75
SSH10.0X240	15,1	5,0	8,92	8,92	10,0	11,05	11,05
			7,62	7,62		9,21	9,21
SSH10.0X280	15,1	5,0	8,92	8,92	10,0	11,05	11,05
			7,62	7,62		9,21	9,21

<sup>1)</sup> For steel thickness  $\leq d$

<sup>2)</sup> Thin plate: thickness  $\leq 0.5xd$

<sup>3)</sup> Thick plate: thickness  $\geq d$

For intermediate steel thicknesses, the strength can be obtained by interpolation.  
For recommended hole diameter in steel see page 29.

Characteristic capacities	11,05	With pre-drill
	9,21	Without pre-drill



## 4. Steel to Timber Fastening

### SSH – Characteristic Capacity Steel to Timber C24 (cont.)

Product Reference	Tension Capacity – C24 – $R_{ax,k}$ [kN] <sup>1)</sup>	Shear Capacity – C24 – [kN]					
		Thin Steel <sup>2)</sup>			Thick Steel <sup>3)</sup>		
		Maximum Thickness [mm]	$R_{v,0^\circ,k}$	$R_{v,90^\circ,k}$	Minimum Thickness [mm]	$R_{v,0^\circ,k}$	$R_{v,90^\circ,k}$
SSH12.0X60	7,0	6,0	6,55	6,55	12,0	9,27	9,27
			3,53	3,53		6,45	6,45
SSH12.0X80	7,0	6,0	8,23	8,23	12,0	10,91	10,91
			4,84	4,84		7,41	7,41
SSH12.0X90	7,0	6,0	8,23	8,23	12,0	10,91	10,91
			5,49	5,49		7,96	7,96
SSH12.0X100	8,1	6,0	8,49	8,49	12,0	11,17	11,17
			6,14	6,14		8,74	8,74
SSH12.0X120	12,4	6,0	9,59	9,59	12,0	12,27	12,27
			7,45	7,45		9,84	9,84
SSH12.0X140	12,4	6,0	9,59	9,59	12,0	12,27	12,27
			7,87	7,87		9,84	9,84
SSH12.0X160	16,1	6,0	10,50	10,50	12,0	13,18	13,18
			8,78	8,78		10,75	10,75
SSH12.0X180	16,1	6,0	10,50	10,50	12,0	13,18	13,18
			8,78	8,78		10,75	10,75
SSH12.0X200	16,1	6,0	10,50	10,50	12,0	13,18	13,18
			8,78	8,78		10,75	10,75

<sup>1)</sup> For steel thickness  $\leq d$

<sup>2)</sup> Thin plate: thickness  $\leq 0.5xd$

<sup>3)</sup> Thick plate: thickness  $\geq d$

For intermediate steel thicknesses, the strength can be obtained by interpolation.

For recommended hole diameter in steel see page 29.

Characteristic capacities	13,18	With pre-drill
	10,75	Without pre-drill

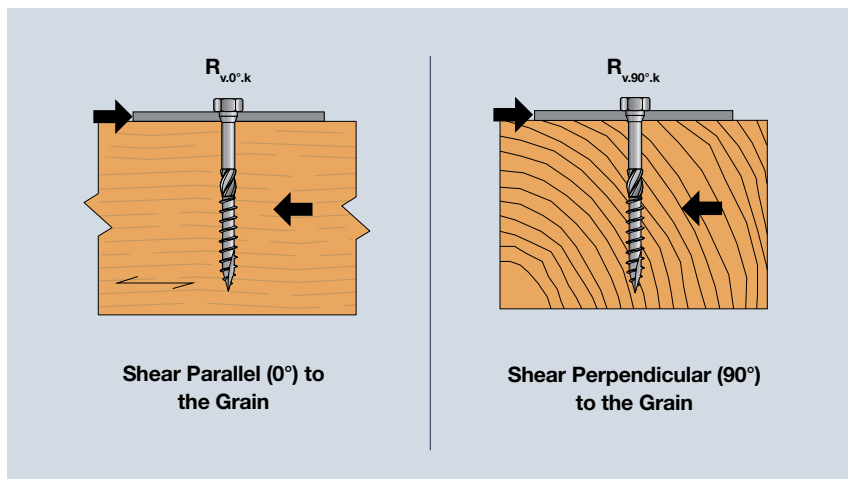

## 4. Steel to Timber Fastening

### SSH – Minimum Distances for Screws in Shear or Combined Loads<sup>1)</sup> Timber to Timber C24

Outer Thread Diameter d [mm]	Pre-drill	Angle Between Load Direction and Screw = 0°						Angle Between Load Direction and Screw = 90°					
		a <sub>1</sub>	a <sub>2</sub>	a <sub>3,c</sub>	a <sub>3,t</sub>	a <sub>4,c</sub>	a <sub>4,t</sub>	a <sub>1</sub>	a <sub>2</sub>	a <sub>3,c</sub>	a <sub>3,t</sub>	a <sub>4,c</sub>	a <sub>4,t</sub>
6.0	With pre-drill	20	12	32	54	14	14	16	16	32	23	14	32
	Without pre-drill	39	20	45	68	23	23	20	20	45	45	23	32
8.0	With pre-drill	22	13	35	60	15	15	17	17	35	25	15	35
	Without pre-drill	51	22	50	75	25	25	22	22	50	50	25	35
10.0	With pre-drill	26	16	42	72	18	18	21	21	42	30	18	42
	Without pre-drill	62	26	60	90	30	30	26	26	60	60	30	42
12.0	With pre-drill	42	26	59	101	26	26	34	34	59	42	26	59
	Without pre-drill	101	42	84	126	42	42	42	42	84	84	42	84

<sup>1)</sup> Minimum distances comply with EN 1995-1-1 (Eurocode 5) and ETA21/0670

<sup>2)</sup> Values given in the table is based on the  $\rho_k \leq 350 \text{ kg/m}^3$

<sup>3)</sup> Minimum distances from the unloaded edge perpendicular to the grain may be reduced to  $a_{4,c} = 3 \times d$  if the spacing parallel to the grain ( $a_1$ ) and the end distance ( $a_{3,t}$ ) is at least  $25 \times d$ .

### SSH – Minimum Distances for Axially Loaded Screws Timber to Timber C24

Outer Thread Diameter d [mm]	a <sub>1</sub>	a <sub>2</sub>	a <sub>3,c</sub>	a <sub>4,c</sub>
6.0	30	21	60	24
8.0	40	28	80	32
10.0	49	35	100	40
12.0	59	42	120	48

\*Valid if the applied centre distances comply with  $a_1, a_2 \geq 25d^2$ .  
Calculation according to EN1995-1-1:2004+A2:2014.

For axially loaded screws installed perpendicular to the surface  $a_{3,t}$  and  $a_{4,t}$  are not relevant. For more info see General Introduction page 24.

See explanation of  $\alpha$  in General Introduction page 23.

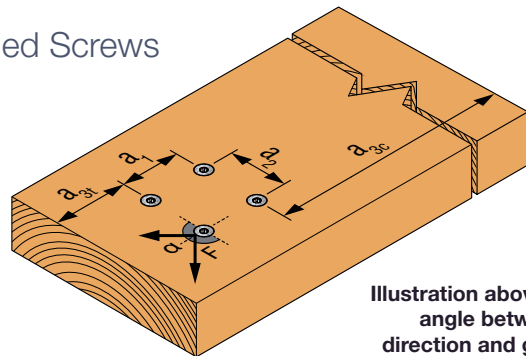

Illustration above shows angle between load direction and grain = 0°

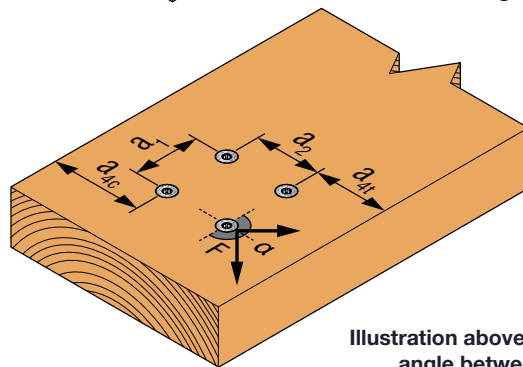

Illustration above shows angle between load direction and grain = 90°

### SSH – Minimum Distances in the Steel Plate

Outer Thread Diameter d [mm]	a <sub>1</sub> *	a <sub>2</sub> *	e <sub>1</sub> *	e <sub>2</sub> *
6.0	14	15	8	8
8.0	18	20	10	10
10.0	22	24	12	12
12.0	27	29	15	15

\*According to EN 1993-1-8 §3.5

Once you have the spacing and edge distance in steel and timber, you pick the maximum for each dimension between steel and timber.

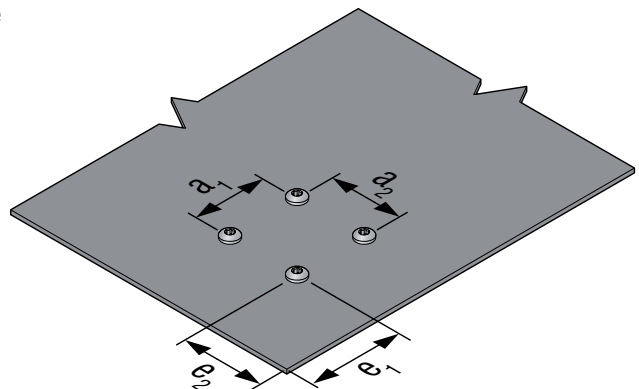

## 4. Steel to Timber Fastening

### **Solid-Drive™** SSF Structural Flat Round Head **CONNECTOR** Screw for Steel to Timber

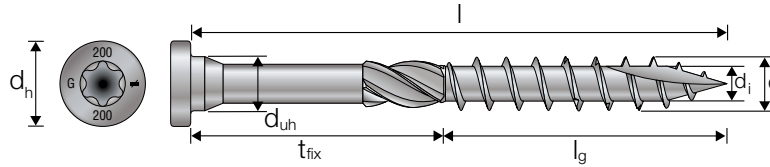
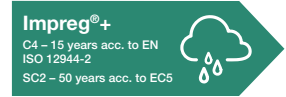

#### SSF – Characteristic Capacity Steel to Timber C24

Product Reference	Tension Capacity – C24 – $R_{ax,k}$ [kN] <sup>1)</sup>	Shear Capacity – C24 – [kN]					
		Thin Steel <sup>2)</sup>			Thick Steel <sup>3)</sup>		
		Maximum Thickness [mm]	$R_{v,0^\circ,k}$	$R_{v,90^\circ,k}$	Minimum Thickness [mm]	$R_{v,0^\circ,k}$	$R_{v,90^\circ,k}$
SSF8.0X40	3,6	4,0	3,04	3,04	8,0	4,75	4,75
			1,77	1,77		3,54	3,54
SSF8.0x60	4,7	4,0	4,73	4,73	8,0	6,39	6,39
			2,76	2,76		4,48	4,48
SSF8.0X80	4,7	4,0	4,93	4,93	8,0	6,48	6,48
			3,74	3,74		5,23	5,23
SSF10.0X60	5,1	5,0	5,68	5,68	10,0	7,68	7,68
			3,16	3,16		5,29	5,29
SSF10.0X80	5,1	5,0	6,41	6,41	10,0	8,54	8,54
			4,32	4,32		6,20	6,20

<sup>1)</sup> For steel thickness  $\leq d$

<sup>2)</sup> Thin plate thickness  $\leq 0.5 \times d$

<sup>3)</sup> Thick plate thickness  $\geq d$

For intermediate steel thicknesses, the strength can be obtained by interpolation.

For recommended hole diameter in steel see page 29.

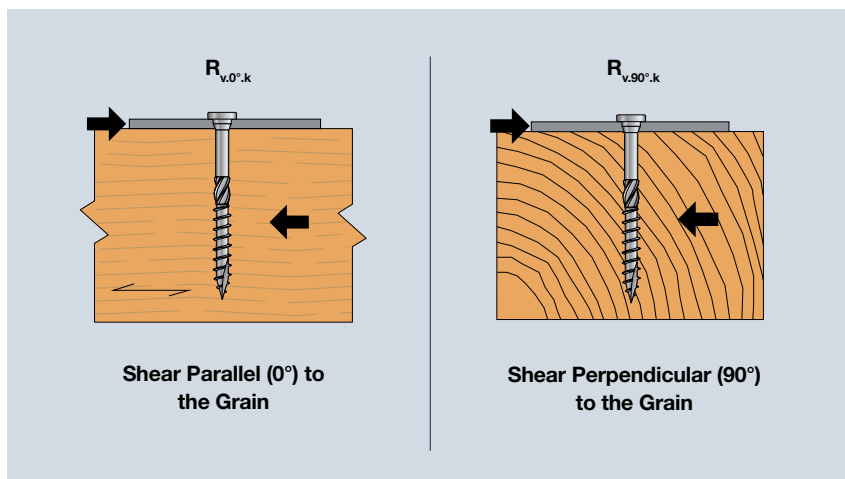
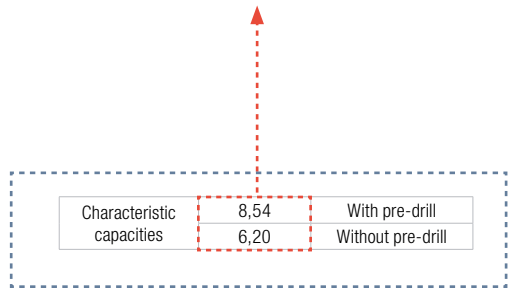

## 4. Steel to Timber Fastening

### SSF – Minimum Distances for Screws in Shear or Combined Loads<sup>1)</sup> Timber to Timber C24

Outer Thread Diameter d [mm]	Pre-drill	Angle between load and grain direction = 0°						Angle between load and grain direction = 90°					
		a <sub>1</sub>	a <sub>2</sub>	a <sub>3,c</sub>	a <sub>3,t</sub>	a <sub>4,c</sub>	a <sub>4,t</sub>	a <sub>1</sub>	a <sub>2</sub>	a <sub>3,c</sub>	a <sub>3,t</sub>	a <sub>4,c</sub>	a <sub>4,t</sub>
8.0	With pre-drill	28	17	56	96	24	24	23	23	56	40	24	56
	Without pre-drill	68	28	80	120	40	40	28	28	80	80	40	80
10.0	With pre-drill	35	21	70	120	30	30	28	28	70	50	30	70
	Without pre-drill	84	35	100	150	50	50	35	35	100	100	50	100

<sup>1)</sup> Minimum distances comply with EN 1995-1-1 (Eurocode 5) and ETA21/0670

<sup>2)</sup> Values given in the table is based on the  $\rho_k \leq 350 \text{ kg/m}^3$

<sup>3)</sup> Minimum distances from the unloaded edge perpendicular to the grain may be reduced to  $a_{4,c} = 3 \times d$  if the spacing parallel to the grain ( $a_1$ ) and the end distance ( $a_{3,t}$ ) is at least  $25 \times d$ .

### SSF – Minimum Distances for Axially Loaded Screws Timber to Timber C24

Outer Thread Diameter d [mm]	a <sub>1</sub>	a <sub>2</sub>	a <sub>3,c</sub>	a <sub>4,c</sub>
8.0	40	28	80	32
10.0	49	35	100	40

\*Valid if the applied centre distances comply with  $a_1, a_2 \geq 25d^2$ .  
Calculation according to EN1995-1-1:2004+A2:2014.

For axially loaded screws installed perpendicular to the surface  $a_{3,t}$  and  $a_{4,t}$  are not relevant. For more info see General Introduction page 24.

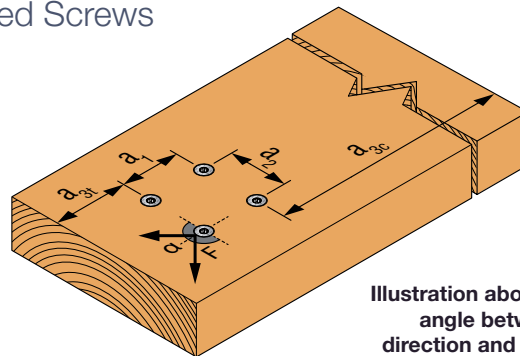

Illustration above shows angle between load direction and grain = 0°

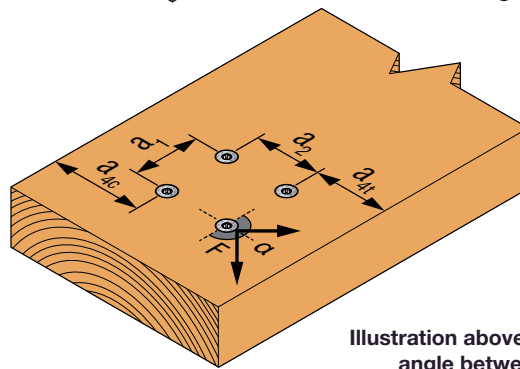

Illustration above shows angle between load direction and grain = 90°

See explanation of  $\alpha$  in General Introduction page 23.

### SSF – Minimum Distances in the Steel Plate

Outer Thread Diameter d [mm]	a <sub>1</sub> *	a <sub>2</sub> *	e <sub>1</sub> *	e <sub>2</sub> *
8.0	18	20	10	10
10.0	22	24	12	12

\*According to EN 1993-1-8 §3.5

Once you have the spacing and edge distance in steel and timber, you pick the maximum for each dimension between steel and timber.

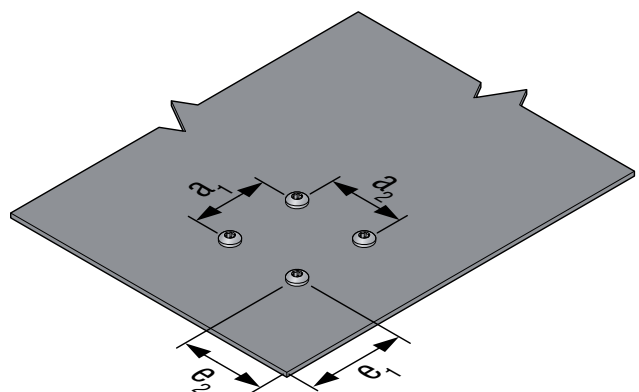

## 4. Steel to Timber Fastening

### **Solid-Drive™** CSA/CSA-Z/CSA-S Structural **CONNECTOR** Screw for Steel to Timber

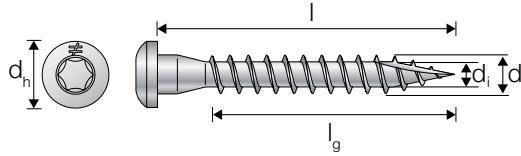

**Electro Galvanised**  
C1 acc. to EN ISO 12944-2  
SC2 – 50 years acc. to EC5

CSA – Characteristic Capacity  
1,0-4,0 mm Steel to Timber C24

Product Reference	Tension Capacity – C24 – $R_{ax,k}$ [kN]	Shear Capacity Parallel and Perpendicular to the Grain – C24 – $R_{v,k}$ [kN]
CSA4.0X30	1,28	1,36
CSA5.0X25	1,38	1,49
CSA5.0X35	2,11	1,99
CSA5.0X40	2,47	2,25
CSA5.0X50	3,20	2,63
CSA5.0X80	5,38	3,50

For recommended hole diameter in steel see page 29.

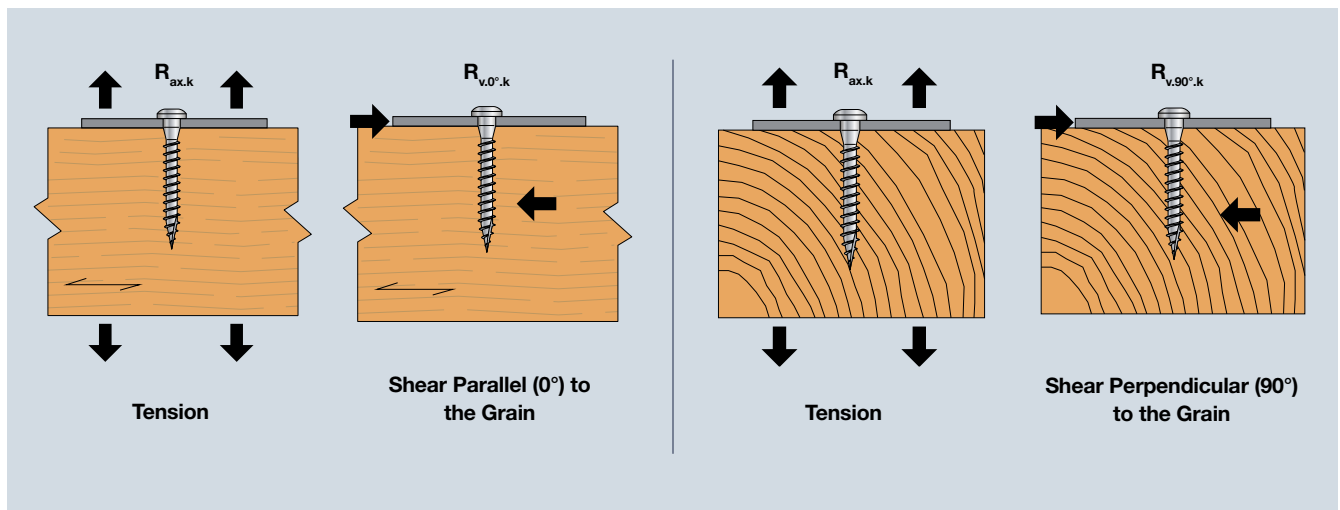

## 4. Steel to Timber Fastening

### **Solid-Drive™** CSA/CSA-Z/CSA-S Structural **CONNECTOR** Screw for Steel to Timber

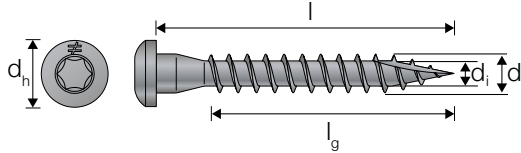

#### CSA-Z – Characteristic Capacity 1,0-4,0 mm Steel to Timber C24

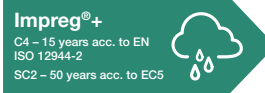

Product Reference	Tension Capacity – C24 – $R_{ax,k}$ [kN]	Shear Capacity Parallel and Perpendicular to the Grain – C24 – $R_{v,k}$ [kN]
CSA5.0X35-Z	2,11	1,99
CSA5.0X40-Z	2,47	2,25
CSA5.0X50-Z	3,20	2,63

For recommended hole diameter in steel see page 29.

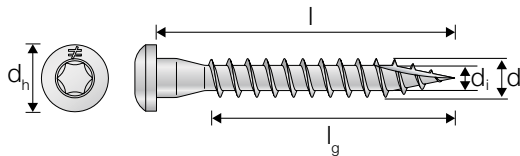

#### CSA-S – Characteristic Capacity 1,0-4,0 mm Steel to Timber C24



Product Reference	Tension Capacity – C24 – $R_{ax,k}$ [kN]	Shear Capacity Parallel and Perpendicular to the Grain – C24 – $R_{v,k}$ [kN]
CSA5.0X25S	1,38	1,49
CSA5.0X35S	2,11	1,99
CSA5.0X40S	2,47	2,25

For recommended hole diameter in steel see page 29.

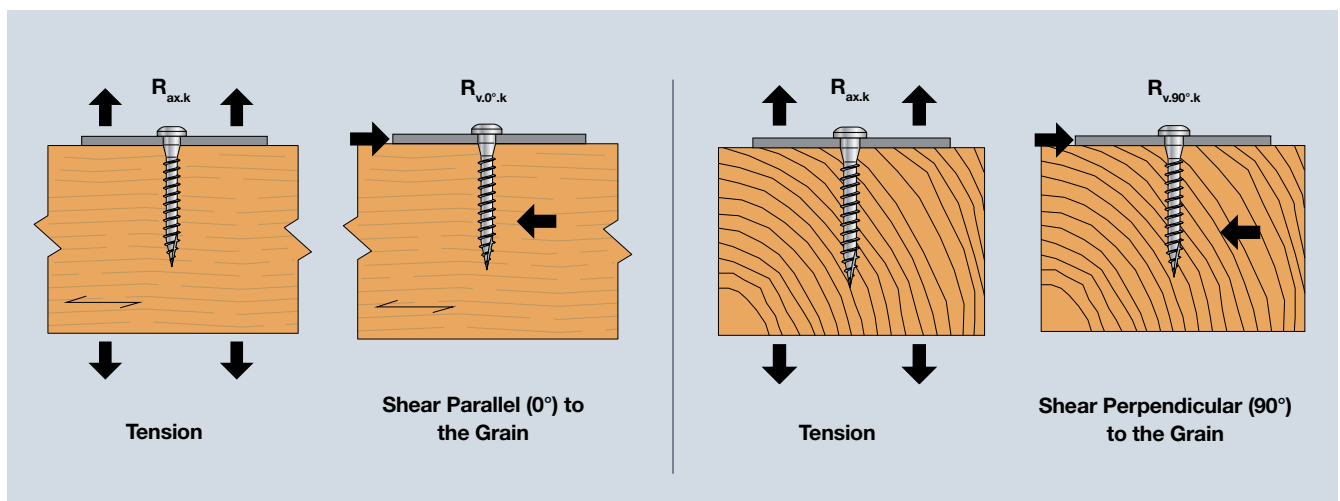

## 4. Steel to Timber Fastening

### CSA – Diameter Selection

Product Reference	Nominal Hole Diameter $d_{f, nom}$ [mm]
CSA4,0	4,0
CSA5,0	5,0

### CSA – Minimum Distances for Screws in Shear or Combined Loads<sup>1)</sup>

#### Timber to Timber C24

Outer Thread Diameter d [mm]	Pre-drill	Angle Between Load Direction and Screw = 0°						Angle Between Load Direction and Screw = 90°					
		$a_1$	$a_2$	$a_{3,c}$	$a_{3,t}$	$a_{4,c}$	$a_{4,t}$	$a_1$	$a_2$	$a_{3,c}$	$a_{3,t}$	$a_{4,c}$	$a_{4,t}$
5.0	With pre-drill	18	11	35	60	15	15	14	14	35	25	15	35
	Without pre-drill	42	18	50	75	25	25	18	18	50	35	25	50

<sup>1)</sup> Minimum distances comply with EN 1995-1-1 (Eurocode 5) and ETA-04/0013

<sup>2)</sup> Values given in the table is based on the  $\rho_k \leq 350 \text{ kg/m}^3$

<sup>3)</sup> Minimum distances from the unloaded edge perpendicular to the grain may be reduced to  $a_{4,c} = 3 \times d$  if the spacing parallel to the grain ( $a_1$ ) and the end distance ( $a_{3,t}$ ) is at least  $25 \times d$ .

### CSA – Minimum Distances for Axially Loaded Screws

#### Timber to Timber C24

Outer Thread Diameter d [mm]	$a_1$	$a_2$	$a_{3,c}$	$a_{4,c}$
5.0	25	18	50	20

\*Valid if the applied centre distances comply with  $a_1, a_2 \geq 25d^2$ . Calculation according to EN1995-1-1:2004+A2:2014.

For axially loaded screws installed perpendicular to the surface  $a_{3,t}$  and  $a_{4,t}$  are not relevant. For more info see General Introduction page 24.

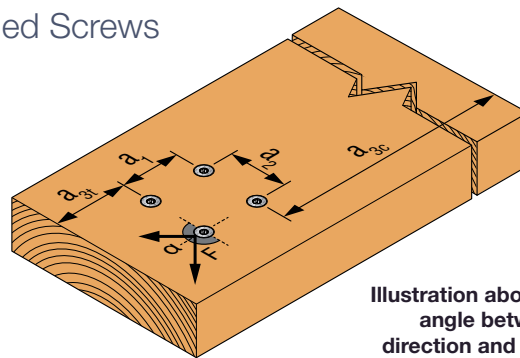

Illustration above shows angle between load direction and grain = 0°

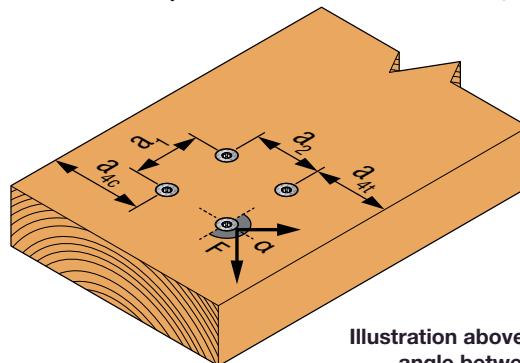

Illustration above shows angle between load direction and grain = 90°

See explanation of  $\alpha$  in General Introduction page 23.

### CSA – Minimum Distances in the Steel Plate

Outer Thread Diameter d [mm]	$a_1^*$	$a_2^*$	$e_1^*$	$e_2^*$
5.0	11	12	6	6

\*According to EN 1993-1-8 §3.5

Once you have the spacing and edge distance in steel and timber, you pick the maximum for each dimension between steel and timber.

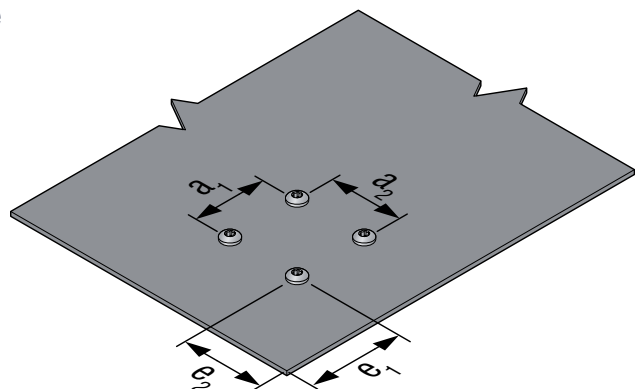



## 4. Steel to Timber Fastening

### **Solid-Drive™** CNA/CNA-G/CNA-S Structural **CONNECTOR** Nail for Steel to Timber

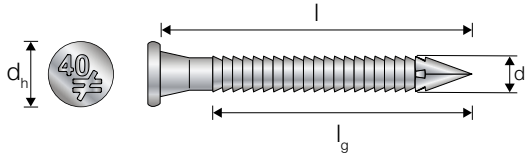

**Electro Galvanised**

C1 acc. to EN ISO 12944-2  
SC2 - 50 years acc. to EC5

CNA – Characteristic Capacity  
1,0-4,0 mm Steel to Timber C24

Product Reference	Tension Capacity – C24 – $R_{ax,k}$ [kN]	Shear Capacity – C24 – $R_{v,k}$ [kN]
CNA4.0X35	0,61	1,66
CNA4.0X40	0,74	1,85
CNA4.0X50	0,98	2,22
CNA4.0X60	1,23	2,36
CNA4.0X75	1,45	2,50
CNA4.0X100	1,43	2,48
CNA6.0X80	2,15	4,47
CNA6.0X100	2,15	4,47

For recommended hole diameter in steel see page 29.

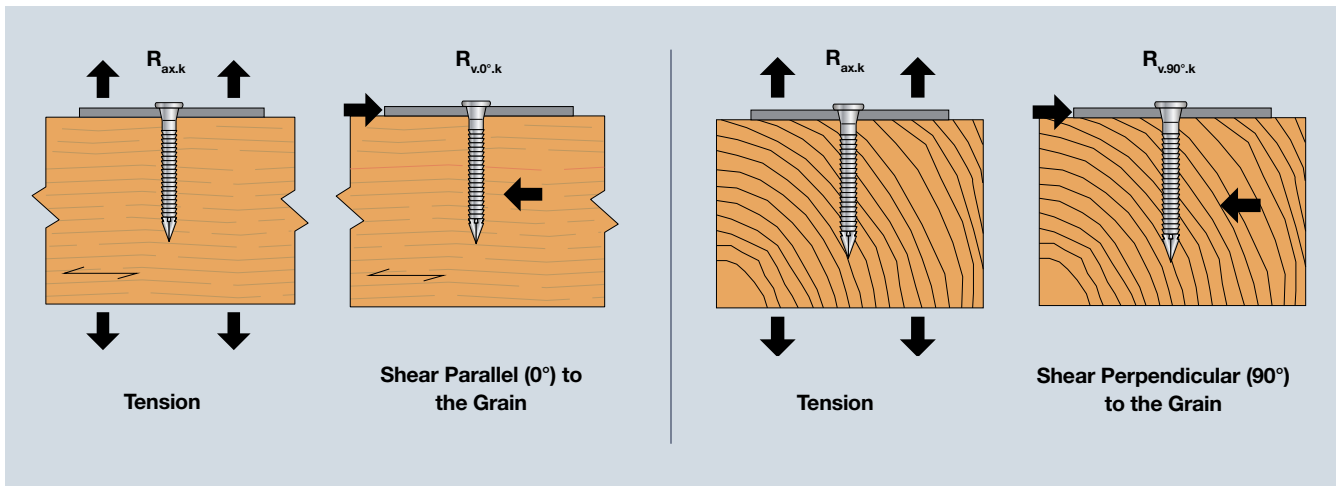

## 4. Steel to Timber Fastening

### **Solid-Drive™** CNA/CNA-G/CNA-S Structural **CONNECTOR** Nail for Steel to Timber

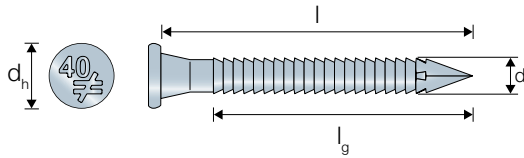

#### CNA-G – Characteristic Capacity 1,0-4,0 mm Steel to Timber C24

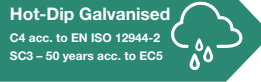

Product Reference	Tension Capacity – C24 – $R_{ax,k}$ [kN]	Shear Capacity – C24 – $R_{v,k}$ [kN]
CNA4.0X40G	0,74	1,86

For recommended hole diameter in steel see page 29.

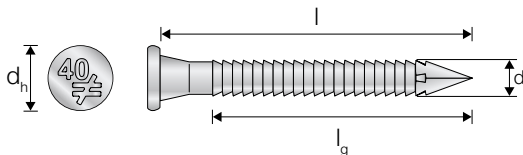

#### CNA-S – Characteristic Capacity 1,0-4,0 mm Steel to Timber C24



Product Reference	Tension Capacity – C24 – $R_{ax,k}$ [kN]	Shear Capacity – C24 – $R_{v,k}$ [kN]
CNA4.0X35S	0,64	1,66
CNA4.0X40S	0,76	1,85
CNA4.0X50S	1,00	2,23
CNA4.0X60S	1,25	2,38

For recommended hole diameter in steel see page 29.



## 4. Steel to Timber Fastening

### CNA – Minimum Distances for Screws in Shear or Combined Loads<sup>1)</sup> Timber to Timber C24

Outer Thread Diameter d [mm]	Pre-drill	Angle Between Load Direction and Screw = 0°						Angle Between Load Direction and Screw = 90°					
		a <sub>1</sub>	a <sub>2</sub>	a <sub>3,c</sub>	a <sub>3,t</sub>	a <sub>4,c</sub>	a <sub>4,t</sub>	a <sub>1</sub>	a <sub>2</sub>	a <sub>3,c</sub>	a <sub>3,t</sub>	a <sub>4,c</sub>	a <sub>4,t</sub>
4.0	With pre-drill	14	9	28	48	12	12	12	12	28	20	12	28
	Without pre-drill	34	14	40	60	20	20	14	14	40	28	20	40

<sup>1)</sup> Minimum distances comply with EN 1995-1-1 (Eurocode 5) and ETA-04/0013

<sup>2)</sup> Values given in the table is based on the  $\rho_k \leq 350 \text{ kg/m}^3$

<sup>3)</sup> Minimum distances from the unloaded edge perpendicular to the grain may be reduced to  $a_{4,c} = 3 \times d$  if the spacing parallel to the grain ( $a_1$ ) and the end distance ( $a_{3,t}$ ) is at least  $25 \times d$ .

### CNA – Minimum Distances for Axially Loaded Screws Timber to Timber C24

Outer Thread Diameter d [mm]	a <sub>1</sub>	a <sub>2</sub>	a <sub>3,c</sub>	a <sub>4,c</sub>
4.0	20	14	40	16

\*Valid if the applied centre distances comply with  $a_1 a_2 \geq 25d^2$ .  
Calculation according to EN1995-1-1:2004+A2:2014.

For axially loaded screws installed perpendicular to the surface  $a_{3,t}$  and  $a_{4,t}$  are not relevant. For more info see General Introduction page 24.

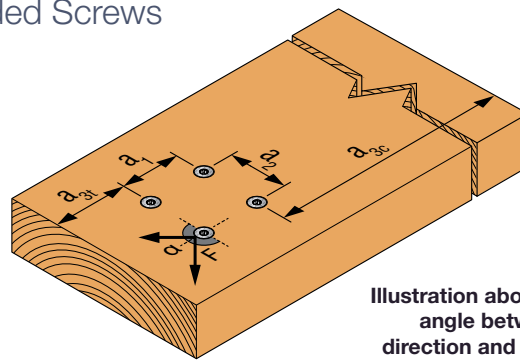

Illustration above shows angle between load direction and grain = 0°

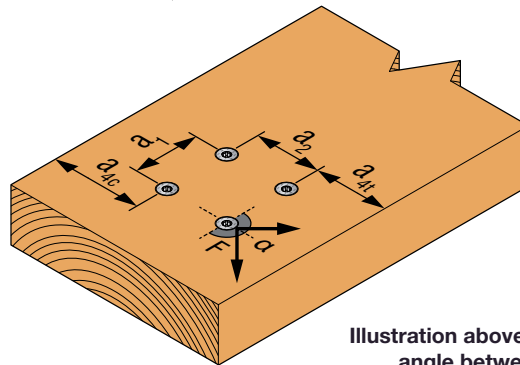

Illustration above shows angle between load direction and grain = 90°

See explanation of  $\alpha$  in General Introduction page 23.

### CNA – Minimum Distances in the Steel Plate

Outer Thread Diameter d [mm]	a <sub>1</sub> *	a <sub>2</sub> *	e <sub>1</sub> *	e <sub>2</sub> *
4.0	9	10	5	5

\*According to EN 1993-1-8 §3.5

Once you have the spacing and edge distance in steel and timber, you pick the maximum for each dimension between steel and timber.

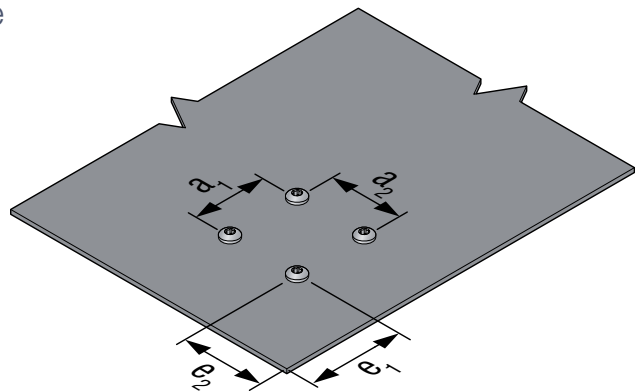

## 4. Steel to Timber Fastening

### Solid-Drive™ TTUFS Countersunk WOOD Screw for Steel to Timber

**Electro Galvanised**  
C1 acc. to EN ISO 12944-2  
SC2 – 50 years acc. to EC5



ETA-21/0670

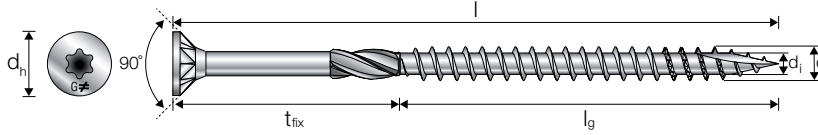

#### TTUFS – Characteristic Capacity Steel to Timber C24

Product Reference	Tension Capacity – C24 – $R_{ax,k}$ [kN] <sup>1)</sup>	Shear Capacity – C24 – [kN]					
		Thin Steel <sup>2)</sup>			Thick Steel <sup>3)</sup>		
		Maximum Thickness [mm]	$R_{v,0°;k}$	$R_{v,90°;k}$	Minimum Thickness [mm]	$R_{v,0°;k}$	$R_{v,90°;k}$
TTUFS4.5X25	1,3	2,25	1,12	1,12	4,5	1,69	1,69
			0,75	0,75			1,33
TTUFS4.5X30	1,7	2,25	1,37	1,37	4,5	1,97	1,97
			0,91	0,91			1,53
TTUFS4.5X35	2,0	2,25	1,62	1,62	4,5	2,24	2,24
			1,08	1,08			1,75
TTUFS4.5X40	2,3	2,25	1,81	1,81	4,5	2,32	2,32
			1,24	1,24			1,97
TTUFS4.5X45	1,9	2,25	1,71	1,71	4,5	2,22	2,22
			1,41	1,41			1,90
TTUFS4.5X50	2,0	2,25	1,73	1,73	4,5	2,24	2,24
			1,50	1,50			1,92
TTUFS4.5X60	2,3	2,25	1,81	1,81	4,5	2,32	2,32
			1,59	1,59			2,00
TTUFS4.5X70	2,6	2,25	1,89	1,89	4,5	2,41	2,41
			1,67	1,67			2,09
TTUFS4.5X80	3,3	2,25	2,06	2,06	4,5	2,57	2,57
			1,83	1,83			2,25

<sup>1)</sup> For steel thickness  $\leq d$

<sup>2)</sup> Thin plate thickness  $\leq 0.5xd$

<sup>3)</sup> Thick plate thickness  $\geq d$

For intermediate steel thicknesses, the strength can be obtained by interpolation.  
For recommended hole diameter in steel see page 29.

Characteristic capacities	2,57	With pre-drill
	2,25	Without pre-drill

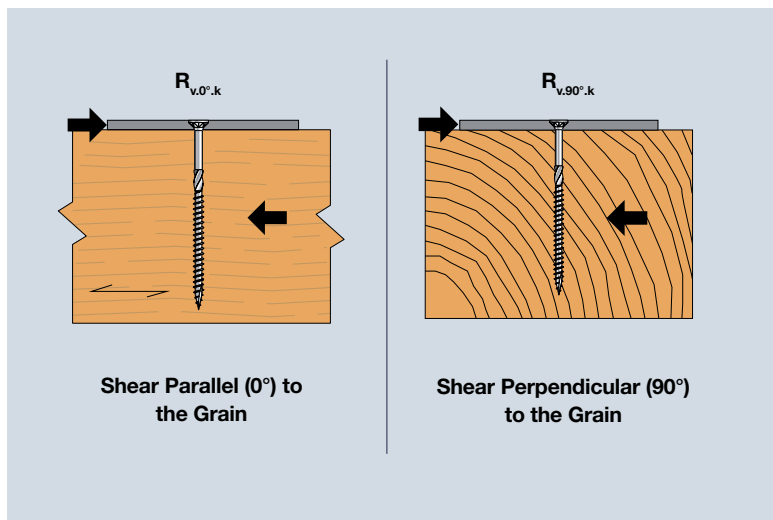

## 4. Steel to Timber Fastening

### TTUFS – Characteristic Capacity Steel to Timber C24 (cont.)

Product Reference	Tension Capacity – C24 – $R_{ax,k}$ [kN] <sup>1)</sup>	Shear Capacity – C24 – [kN]					
		Thin Steel <sup>2)</sup>			Thick Steel <sup>3)</sup>		
		Maximum Thickness [mm]	$R_{v,0^\circ,k}$	$R_{v,90^\circ,k}$	Minimum Thickness [mm]	$R_{v,0^\circ,k}$	$R_{v,90^\circ,k}$
TTUFS5.0X30	1,9	2,5	1,50	1,50	5	2,25	2,25
			0,97	0,97		1,75	1,75
TTUFS5.0X40	2,6	2,5	2,04	2,04	5	2,86	2,86
			1,33	1,33		2,20	2,20
TTUFS5.0X50	2,3	2,5	2,12	2,12	5	2,76	2,76
			1,68	1,68		2,34	2,34
TTUFS5.0X60	2,6	2,5	2,21	2,21	5	2,86	2,86
			1,91	1,91		2,43	2,43
TTUFS5.0X70	3,0	2,5	2,31	2,31	5	2,95	2,95
			2,00	2,00		2,52	2,52
TTUFS5.0X80	3,0	2,5	2,31	2,31	5	2,95	2,95
			2,00	2,00		2,52	2,52
TTUFS5.0X90	3,4	2,5	2,40	2,40	5	3,05	3,05
			2,10	2,10		2,62	2,62
TTUFS5.0X100	4,5	2,5	2,68	2,68	5	3,33	3,33
			2,38	2,38		2,90	2,90
TTUFS5.0X120	4,5	2,5	2,68	2,68	5	3,33	3,33
			2,38	2,38		2,90	2,90
TTUFS6.0X40	2,6	3	2,40	2,40	6	3,30	3,30
			1,49	1,49		2,43	2,43
TTUFS6.0X50	2,3	3	2,58	2,58	6	3,41	3,41
			1,89	1,89		2,69	2,69
TTUFS6.0X60	2,6	3	2,67	2,67	6	3,51	3,51
			2,25	2,25		2,90	2,90
TTUFS6.0X70	3,0	3	2,77	2,77	6	3,60	3,60
			2,34	2,34		3,00	3,00
TTUFS6.0X80	3,0	3	2,77	2,77	6	3,60	3,60
			2,34	2,34		3,00	3,00
TTUFS6.0X90	3,4	3	2,86	2,86	6	3,70	3,70
			2,43	2,43		3,09	3,09
TTUFS6.0X100	4,5	3	3,14	3,14	6	3,98	3,98
			2,71	2,71		3,37	3,37
TTUFS6.0X120	5,3	3	3,33	3,33	6	4,16	4,16
			2,90	2,90		3,56	3,56
TTUFS6.0X140	5,3	3	3,33	3,33	6	4,16	4,16
			2,90	2,90		3,56	3,56
TTUFS6.0X160	5,3	3	3,33	3,33	6	4,16	4,16
			2,90	2,90		3,56	3,56
TTUFS6.0X180	5,3	3	3,33	3,33	6	4,16	4,16
			2,90	2,90		3,56	3,56

<sup>1)</sup> For steel thickness  $\leq d$

<sup>2)</sup> Thin plate thickness  $\leq 0.5xd$

<sup>3)</sup> Thick plate thickness  $\geq d$

For intermediate steel thicknesses, the strength can be obtained by interpolation.  
For recommended hole diameter in steel see page 29.

Characteristic capacities	4,16	With pre-drill
	3,56	Without pre-drill

## 4. Steel to Timber Fastening

### **Solid-Drive™** TTZNFS Impreg® + Coated Countersunk **WOOD** Screw for Steel to Timber

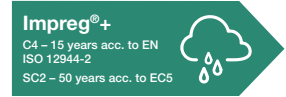

ETA-21/0670

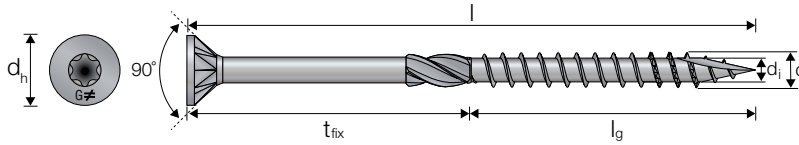

#### TTZNFS – Characteristic Capacity Steel to Timber C24

Product Reference	Tension Capacity – C24 – $R_{ax,k}$ [kN] <sup>1)</sup>	Shear Capacity – C24 – [kN]					
		Thin Steel <sup>2)</sup>			Thick Steel <sup>3)</sup>		
		Maximum Thickness [mm]	$R_{v,0°k}$	$R_{v,90°k}$	Minimum Thickness [mm]	$R_{v,0°k}$	$R_{v,90°k}$
TTZNFS4.5X25	1,3	2,25	1,12	1,12	4,5	1,69	1,69
			0,75	0,75			1,33
TTZNFS4.5X30	1,7	2,25	1,37	1,37	4,5	1,97	1,97
			0,91	0,91			1,53
TTZNFS4.5X35	2,0	2,25	1,62	1,62	4,5	2,24	2,24
			1,08	1,08			1,75
TTZNFS4.5X40	2,3	2,25	1,81	1,81	4,5	2,32	2,32
			1,24	1,24			1,97
TTZNFS4.5X45	1,9	2,25	1,71	1,71	4,5	2,22	2,22
			1,41	1,41			1,90
TTZNFS4.5X50	2,0	2,25	1,73	1,73	4,5	2,24	2,24
			1,50	1,50			1,92
TTZNFS4.5X60	2,3	2,25	1,81	1,81	4,5	2,32	2,32
			1,59	1,59			2,00
TTZNFS4.5X70	2,6	2,25	1,89	1,89	4,5	2,41	2,41
			1,67	1,67			2,09
TTZNFS4.5X80	3,3	2,25	2,06	2,06	4,5	2,57	2,57
			1,83	1,83			2,25

<sup>1)</sup> For steel thickness  $\leq d$

<sup>2)</sup> Thin plate thickness  $\leq 0.5x d$

<sup>3)</sup> Thick plate thickness  $\geq d$

For intermediate steel thicknesses, the strength can be obtained by interpolation.  
For recommended hole diameter in steel see page 29.

Characteristic capacities	2,57	With pre-drill
	2,25	Without pre-drill

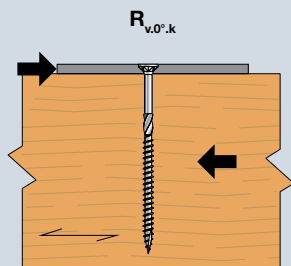

Shear Parallel (0°) to the Grain

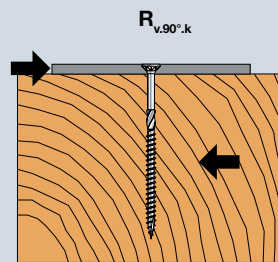

Shear Perpendicular (90°) to the Grain

## 4. Steel to Timber Fastening

### TTZNFS – Characteristic Capacity Steel to Timber C24 (cont.)

Product Reference	Tension Capacity – C24 – $R_{ax,k}$ [kN] <sup>1)</sup>	Shear Capacity – C24 – [kN]					
		Thin Steel <sup>2)</sup>			Thick Steel <sup>3)</sup>		
		Maximum Thickness [mm]	$R_{v,0^\circ,k}$	$R_{v,90^\circ,k}$	Minimum Thickness [mm]	$R_{v,0^\circ,k}$	$R_{v,90^\circ,k}$
TTZNFS5.0X30	1,9	2,5	1,50	1,50	5	2,25	2,25
			0,97	0,97		1,75	1,75
TTZNFS5.0X40	2,6	2,5	2,04	2,04	5	2,86	2,86
			1,33	1,33		2,20	2,20
TTZNFS5.0X50	2,3	2,5	2,12	2,12	5	2,76	2,76
			1,68	1,68		2,34	2,34
TTZNFS5.0X60	2,6	2,5	2,21	2,21	5	2,86	2,86
			1,91	1,91		2,43	2,43
TTZNFS5.0X70	3,0	2,5	2,31	2,31	5	2,95	2,95
			2,00	2,00		2,52	2,52
TTZNFS5.0X80	3,0	2,5	2,31	2,31	5	2,95	2,95
			2,00	2,00		2,52	2,52
TTZNFS5.0X90	3,4	2,5	2,40	2,40	5	3,05	3,05
			2,10	2,10		2,62	2,62
TTZNFS5.0X100	4,5	2,5	2,68	2,68	5	3,33	3,33
			2,38	2,38		2,90	2,90
TTZNFS5.0X120	4,5	2,5	2,68	2,68	5	3,33	3,33
			2,38	2,38		2,90	2,90
TTZNFS6.0X40	2,6	3	2,40	2,40	6	3,30	3,30
			1,49	1,49		2,43	2,43
TTZNFS6.0X50	2,3	3	2,58	2,58	6	3,41	3,41
			1,89	1,89		2,69	2,69
TTZNFS6.0X60	2,6	3	2,67	2,67	6	3,51	3,51
			2,25	2,25		2,90	2,90
TTZNFS6.0X70	3,0	3	2,77	2,77	6	3,60	3,60
			2,34	2,34		3,00	3,00
TTZNFS6.0X80	3,0	3	2,77	2,77	6	3,60	3,60
			2,34	2,34		3,00	3,00
TTZNFS6.0X90	3,4	3	2,86	2,86	6	3,70	3,70
			2,43	2,43		3,09	3,09
TTZNFS6.0X100	4,5	3	3,14	3,14	6	3,98	3,98
			2,71	2,71		3,37	3,37
TTZNFS6.0X120	5,3	3	3,33	3,33	6	4,16	4,16
			2,90	2,90		3,56	3,56
TTZNFS6.0X140	5,3	3	3,33	3,33	6	4,16	4,16
			2,90	2,90		3,56	3,56
TTZNFS6.0X160	5,3	3	3,33	3,33	6	4,16	4,16
			2,90	2,90		3,56	3,56
TTZNFS6.0X180	5,3	3	3,33	3,33	6	4,16	4,16
			2,90	2,90		3,56	3,56

<sup>1)</sup> For steel thickness  $\leq d$

<sup>2)</sup> Thin plate thickness  $\leq 0.5xd$

<sup>3)</sup> Thick plate thickness  $\geq d$

For intermediate steel thicknesses, the strength can be obtained by interpolation.

For recommended hole diameter in steel see page 29.

Characteristic capacities	4,16	With pre-drill
	3,56	Without pre-drill



## 4. Steel to Timber Fastening

### Solid-Drive™ TTSFS Stainless Steel A4 Countersunk WOOD Screw for Steel to Timber

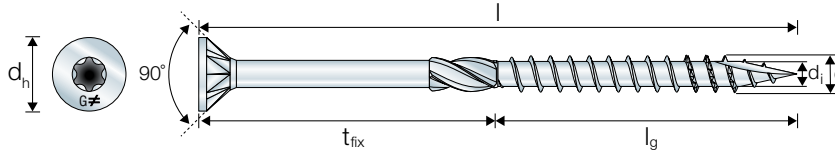

#### TTSFS – Characteristic Capacity Steel to Timber C24

Product Reference	Tension Capacity – C24 – $R_{ax,k}$ [kN] <sup>1)</sup>	Shear Capacity – C24 – [kN]					
		Thin Steel <sup>2)</sup>			Thick Steel <sup>3)</sup>		
		Maximum Thickness [mm]	$R_{v,0^\circ,k}$	$R_{v,90^\circ,k}$	Minimum Thickness [mm]	$R_{v,0^\circ,k}$	$R_{v,90^\circ,k}$
TTSFS5.0x60	2,4	2,5	1,90	1,90	5	2,44	2,44
			1,65	1,65			2,08
TTSFS5.0x70	2,6	2,5	1,96	1,96	5	2,49	2,49
			1,70	1,70			2,14
TTSFS5.0x80	3,0	2,5	2,05	2,05	5	2,59	2,59
			1,80	1,80			2,23
TTSFS5.0x90	3,4	2,5	2,14	2,14	5	2,68	2,68
			1,89	1,89			2,32
TTSFS5.0x100	4,1	2,5	2,33	2,33	5	2,87	2,87
			2,07	2,07			2,51
TTSFS5.0x120	4,5	2,5	2,42	2,42	5	2,96	2,96
			2,10	2,10			2,60
TTSFS6.0x70	2,9	3	2,63	2,63	6	3,42	3,42
			2,22	2,22			2,85
TTSFS6.0x80	3,3	3	2,73	2,73	6	3,52	3,52
			2,33	2,33			2,95
TTSFS6.0x90	3,7	3	2,83	2,83	6	3,63	3,63
			2,43	2,43			3,05
TTSFS6.0x100	4,5	3	3,04	3,04	6	3,83	3,83
			2,63	2,63			3,26
TTSFS6.0x120	4,9	3	3,14	3,14	6	3,93	3,93
			2,73	2,73			3,36
TTSFS6.0x140	5,3	3	3,24	3,24	6	4,03	4,03
			2,84	2,84			3,46

<sup>1)</sup> For steel thickness  $\leq d$

<sup>2)</sup> Thin plate thickness  $\leq 0.5 \times d$

<sup>3)</sup> Thick plate thickness  $\geq d$

For intermediate steel thicknesses, the strength can be obtained by interpolation.  
For recommended hole diameter in steel see page 29.

Characteristic capacities	4,03	With pre-drill
	3,46	Without pre-drill

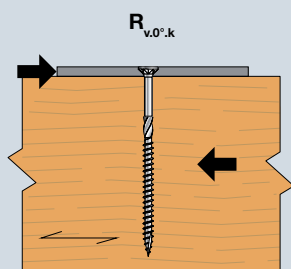

Shear Parallel (0°) to the Grain

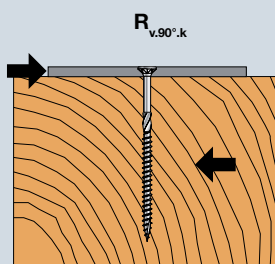

Shear Perpendicular (90°) to the Grain

## 4. Steel to Timber Fastening

### TTUFS/TTZNFS/TTSFS – Minimum Distances for Screws in Shear or Combined Loads<sup>1)</sup> Timber to Timber C24

Outer Thread Diameter d [mm]	Pre-drill	Angle Between Load Direction and Screw = 0°						Angle Between Load Direction and Screw = 90°					
		a <sub>1</sub>	a <sub>2</sub>	a <sub>3,c</sub>	a <sub>3,t</sub>	a <sub>4,c</sub>	a <sub>4,t</sub>	a <sub>1</sub>	a <sub>2</sub>	a <sub>3,c</sub>	a <sub>3,t</sub>	a <sub>4,c</sub>	a <sub>4,t</sub>
4.5	With pre-drill	16	10	32	54	14	14	13	13	32	23	14	32
	Without pre-drill	38	16	45	68	23	23	16	16	45	32	23	45
5.0	With pre-drill	18	11	35	60	15	15	14	14	35	25	15	35
	Without pre-drill	42	18	50	75	25	25	18	18	50	35	25	50
6.0	With pre-drill	21	13	42	72	18	18	17	17	42	30	18	42
	Without pre-drill	51	21	60	90	30	30	21	21	60	42	30	60

<sup>1)</sup> Minimum distances comply with EN 1995-1-1 (Eurocode 5) and ETA21/0670

<sup>2)</sup> Values given in the table is based on the  $\rho_k \leq 350 \text{ kg/m}^3$

<sup>3)</sup> Minimum distances from the unloaded edge perpendicular to the grain may be reduced to  $a_{4,c} = 3 \times d$  if the spacing parallel to the grain ( $a_1$ ) and the end distance ( $a_{3,t}$ ) is at least  $25 \times d$ .

### TTUFS/TTZNFS/TTSFS – Minimum Distances for Axially Loaded Screws Timber to Timber C24

Outer Thread Diameter d [mm]	a <sub>1</sub>	a <sub>2</sub>	a <sub>3,c</sub>	a <sub>4,c</sub>
4.5	23	16	45	18
5.0	25	18	50	20
6.0	30	21	60	24

\*Valid if the applied centre distances comply with  $a_1 a_2 \geq 25d^2$ .  
Calculation according to EN1995-1-1:2004+A2:2014.

For axially loaded screws installed perpendicular to the surface  $a_{3,t}$  and  $a_{4,t}$  are not relevant. For more info see General Introduction page 24.

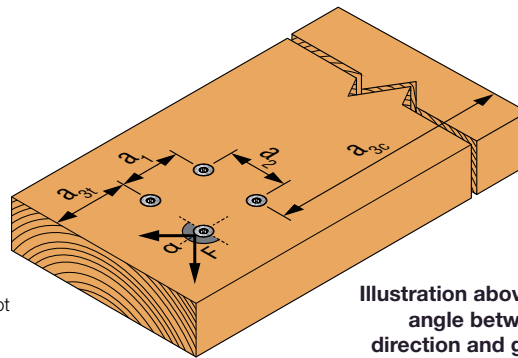

Illustration above shows angle between load direction and grain = 0°

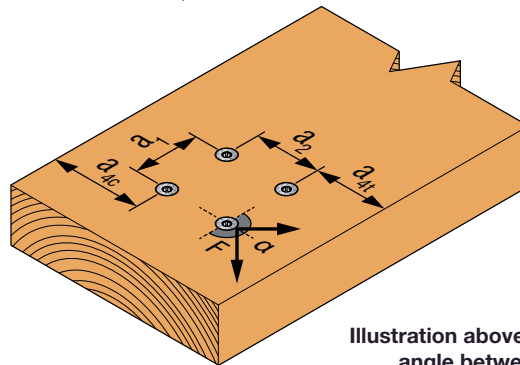

Illustration above shows angle between load direction and grain = 90°

See explanation of  $\alpha$  in General Introduction page 23.

### TTUFS/TTZNFS/TTSFS – Minimum Distances in the Steel Plate

Outer Thread Diameter d [mm]	a <sub>1</sub> *	a <sub>2</sub> *	e <sub>1</sub> *	e <sub>2</sub> *
4.5	10	11	6	6
5.0	11	12	6	6
6.0	14	15	8	8

\*According to EN 1993-1-8 §3.5

Once you have the spacing and edge distance in steel and timber, you pick the maximum for each dimension between steel and timber.

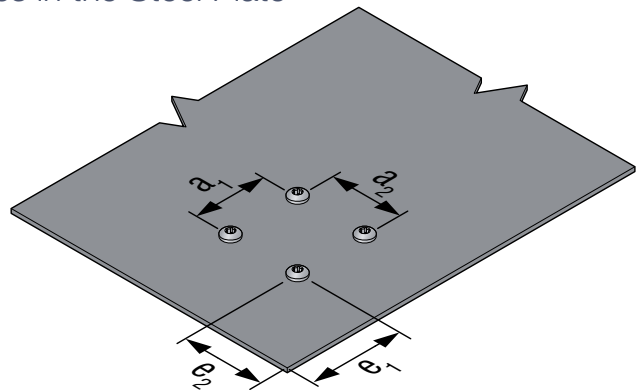

## 4. Steel to Timber Fastening

### Solid-Drive™ SWC Structural Countersunk WOOD Screw for Steel to Timber

Yellow Zinc Plated  
C2 acc. to EN ISO 12944-2  
SC2 – 50 years acc. to EC5

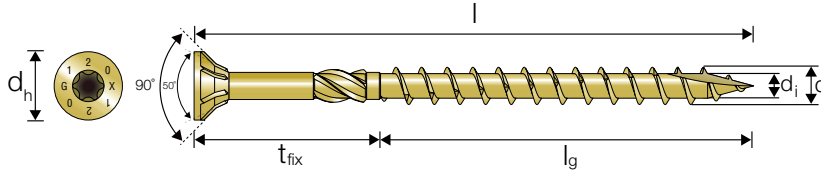

#### SWC – Characteristic Capacity Steel to Timber C24

Product Reference	Tension Capacity – C24 – $R_{ax,k}$ [kN] <sup>1)</sup>	Shear Capacity – C24 – [kN]					
		Thin Steel <sup>2)</sup>			Thick Steel <sup>3)</sup>		
		Maximum Thickness [mm]	$R_{v,0°k}$	$R_{v,90°k}$	Minimum Thickness [mm]	$R_{v,0°k}$	$R_{v,90°k}$
SWC6.0X200	5,5	3	3,49	3,49	6	4,36	4,36
	3,04		3,04	3,73		3,73	
SWC6.0X220	5,5	3	3,49	3,49	6	4,36	4,36
	3,04		3,04	3,73		3,73	
SWC6.0X240	5,5	3	3,49	3,49	6	4,36	4,36
	3,04		3,04	3,73		3,73	
SWC6.0X260	5,5	3	3,49	3,49	6	4,36	4,36
	3,04		3,04	3,73		3,73	
SWC6.0X280	5,5	3	3,49	3,49	6	4,36	4,36
	3,04		3,04	3,73		3,73	
SWC6.0X300	5,5	3	3,49	3,49	6	4,36	4,36
	3,04		3,04	3,73		3,73	

<sup>1)</sup> For steel thickness  $\leq d$

<sup>2)</sup> Thin plate thickness  $\leq 0.5xd$

<sup>3)</sup> Thick plate thickness  $\geq d$

For intermediate steel thicknesses, the strength can be obtained by interpolation.  
For recommended hole diameter in steel see page 29.

Characteristic capacities	4,36	With pre-drill
	3,73	Without pre-drill

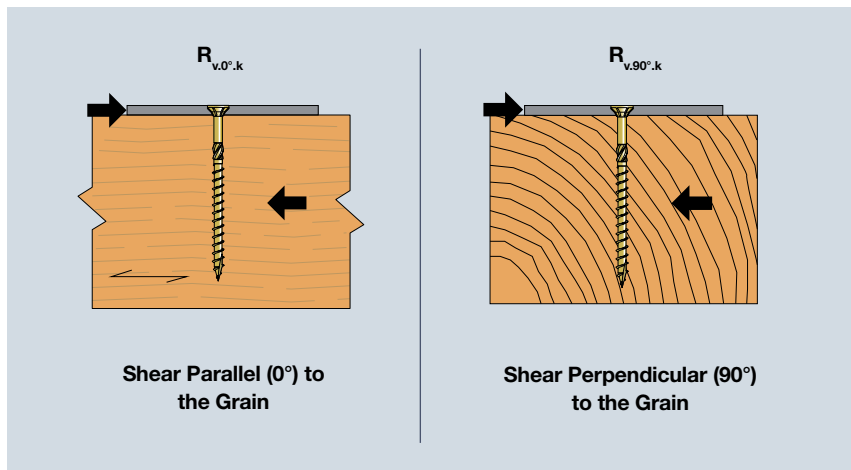

## 4. Steel to Timber Fastening

### SWC – Characteristic Capacity Steel to Timber C24 (cont.)

Product Reference	Tension Capacity – C24 – $R_{ax,k}$ [kN] <sup>1)</sup>	Shear Capacity – C24 – [kN]					
		Thin Steel <sup>2)</sup>			Thick Steel <sup>3)</sup>		
		Maximum Thickness [mm]	$R_{v,0^\circ,k}$	$R_{v,90^\circ,k}$	Minimum Thickness [mm]	$R_{v,0^\circ,k}$	$R_{v,90^\circ,k}$
SWC8.0X80	5,0	4	5,06	5,06	8	6,64	6,64
			3,74	3,74		5,37	5,37
SWC8.0X100	5,0	4	5,06	5,06	8	6,64	6,64
			4,16	4,16		5,37	5,37
SWC8.0X120	8,1	4	5,82	5,82	8	7,40	7,40
			4,92	4,92		6,12	6,12
SWC8.0X140	8,1	4	5,82	5,82	8	7,40	7,40
			4,92	4,92		6,12	6,12
SWC8.0X160	8,1	4	5,82	5,82	8	7,40	7,40
			4,92	4,92		6,12	6,12
SWC8.0X180	8,1	4	5,82	5,82	8	7,40	7,40
			4,92	4,92		6,12	6,12
SWC8.0X200	8,1	4	5,82	5,82	8	7,40	7,40
			4,92	4,92		6,12	6,12
SWC8.0X220	8,1	4	5,82	5,82	8	7,40	7,40
			4,92	4,92		6,12	6,12
SWC8.0X240	8,1	4	5,82	5,82	8	7,40	7,40
			4,92	4,92		6,12	6,12
SWC8.0X260	8,1	4	5,82	5,82	8	7,40	7,40
			4,92	4,92		6,12	6,12
SWC8.0X280	8,1	4	5,82	5,82	8	7,40	7,40
			4,92	4,92		6,12	6,12
SWC8.0X300	8,1	4	5,82	5,82	8	7,40	7,40
			4,92	4,92		6,12	6,12
SWC8.0X320	8,1	4	5,82	5,82	8	7,40	7,40
			4,92	4,92		6,12	6,12
SWC8.0X340	8,1	4	5,82	5,82	8	7,40	7,40
			4,92	4,92		6,12	6,12
SWC8.0X360	8,1	4	5,82	5,82	8	7,40	7,40
			4,92	4,92		6,12	6,12
SWC8.0X380	8,1	4	5,82	5,82	8	7,40	7,40
			4,92	4,92		6,12	6,12
SWC8.0X400	8,1	4	5,82	5,82	8	7,40	7,40
			4,92	4,92		6,12	6,12
SWC10.0X100	6,1	5	6,99	6,99	10	9,25	9,25
			5,47	5,47		7,29	7,29
SWC10.0X120	6,1	5	6,99	6,99	10	9,25	9,25
			5,60	5,60		7,29	7,29
SWC10.0X140	9,8	5	7,90	7,90	10	10,17	10,17
			6,52	6,52		8,21	8,21
SWC10.0X160	9,8	5	7,90	7,90	10	10,17	10,17
			6,52	6,52		8,21	8,21
SWC10.0X180	9,8	5	7,90	7,90	10	10,17	10,17
			6,52	6,52		8,21	8,21
SWC10.0X200	9,8	5	7,90	7,90	10	10,17	10,17
			6,52	6,52		8,21	8,21
SWC10.0X220	9,8	5	7,90	7,90	10	10,17	10,17
			6,52	6,52		8,21	8,21
SWC10.0X240	9,8	5	7,90	7,90	10	10,17	10,17
			6,52	6,52		8,21	8,21
SWC10.0X260	9,8	5	7,90	7,90	10	10,17	10,17
			6,52	6,52		8,21	8,21
SWC10.0X280	9,8	5	7,90	7,90	10	10,17	10,17
			6,52	6,52		8,21	8,21
SWC10.0X300	9,8	5	7,90	7,90	10	10,17	10,17
			6,52	6,52		8,21	8,21
SWC10.0X320	9,8	5	7,90	7,90	10	10,17	10,17
			6,52	6,52		8,21	8,21
SWC10.0X340	9,8	5	7,90	7,90	10	10,17	10,17
			6,52	6,52		8,21	8,21
SWC10.0X360	9,8	5	7,90	7,90	10	10,17	10,17
			6,52	6,52		8,21	8,21
SWC10.0X380	9,8	5	7,90	7,90	10	10,17	10,17
			6,52	6,52		8,21	8,21
SWC10.0X400	9,8	5	7,90	7,90	10	10,17	10,17
			6,52	6,52		8,21	8,21

<sup>1)</sup> For steel thickness  $\leq d$

<sup>2)</sup> Thin plate thickness  $\leq 0,5d$

<sup>3)</sup> Thick plate thickness  $\geq d$

For intermediate steel thicknesses, the strength can be obtained by interpolation.

For recommended hole diameter in steel see page 29.

## 4. Steel to Timber Fastening

### SWC – Minimum Distances for Screws in Shear or Combined Loads<sup>1)</sup> Timber to Timber C24

Outer Thread Diameter d [mm]	Pre-drill	Angle Between Load Direction and Screw = 0°						Angle Between Load Direction and Screw = 90°					
		a <sub>1</sub>	a <sub>2</sub>	a <sub>3,c</sub>	a <sub>3,t</sub>	a <sub>4,c</sub>	a <sub>4,t</sub>	a <sub>1</sub>	a <sub>2</sub>	a <sub>3,c</sub>	a <sub>3,t</sub>	a <sub>4,c</sub>	a <sub>4,t</sub>
6.0	With pre-drill	21	13	42	72	18	18	17	17	42	30	18	42
	Without pre-drill	51	21	60	90	30	30	21	21	60	42	30	60
8.0	With pre-drill	28	17	56	96	24	24	23	23	56	40	24	56
	Without pre-drill	68	28	80	120	40	40	28	28	80	80	40	80
10.0	With pre-drill	35	21	70	120	30	30	28	28	70	50	30	70
	Without pre-drill	84	35	100	150	50	50	35	35	100	100	50	100

<sup>1)</sup> Minimum distances comply with EN 1995-1-1 (Eurocode 5) and ETA21/0670

<sup>2)</sup> Values given in the table is based on the  $\rho_k \leq 350 \text{ kg/m}^3$

<sup>3)</sup> Minimum distances from the unloaded edge perpendicular to the grain may be reduced to  $a_{4,c} = 3 \times d$  if the spacing parallel to the grain ( $a_1$ ) and the end distance ( $a_{3,t}$ ) is at least  $25 \times d$ .

### SWC – Minimum Distances for Axially Loaded Screws Timber to Timber C24

Outer Thread Diameter d [mm]	a <sub>1</sub>	a <sub>2</sub>	a <sub>3c</sub>	a <sub>4c</sub>
6.0	30	21	60	24
8.0	40	28	80	32
10.0	49	35	100	40

\*Valid if the applied centre distances comply with  $a_1, a_2 \geq 25d^2$ .  
Calculation according to EN1995-1-1:2004+A2:2014.

For axially loaded screws installed perpendicular to the surface  $a_{3,t}$  and  $a_{4,t}$  are not relevant.  
For more info see General Introduction page 24.

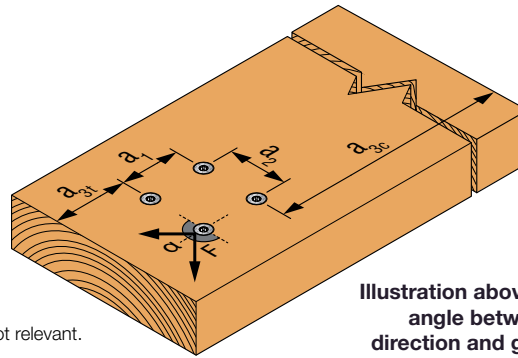

Illustration above shows angle between load direction and grain = 0°

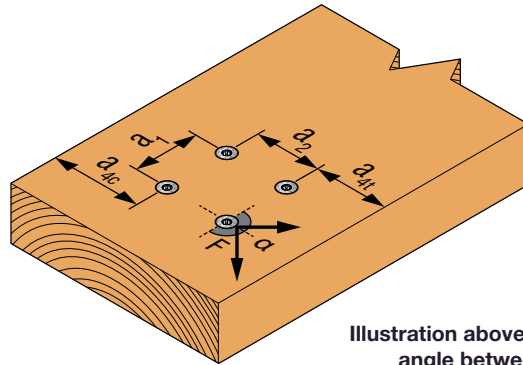

Illustration above shows angle between load direction and grain = 90°

See explanation of  $\alpha$  in General Introduction page 23.

### SWC – Minimum Distances in the Steel Plate

Outer Thread Diameter d [mm]	a <sub>1</sub> *	a <sub>2</sub> *	e <sub>1</sub> *	e <sub>2</sub> *
6.0	14	15	8	8
8.0	18	20	10	10
10.0	22	24	12	12

\*According to EN 1993-1-8 §3.5

Once you have the spacing and edge distance in steel and timber, you pick the maximum for each dimension between steel and timber.

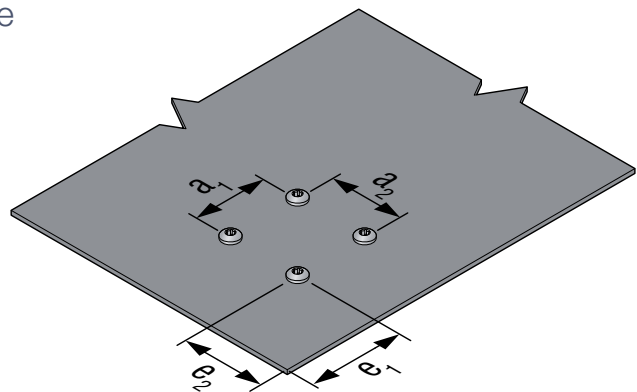

## 4. Steel to Timber Fastening

### **Solid-Drive™** ESCRFTC Full Threaded **WOOD** Screw for Steel to Timber

**Yellow Zinc Plated**  
C2 acc. to EN ISO 12944-2  
SC2 – 50 years acc. to EC5



ETA-13/0796

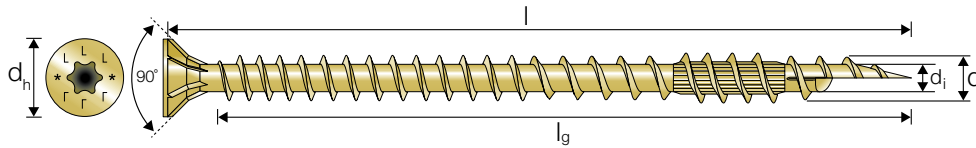

#### ESCRFTC – Characteristic Capacity Steel to Timber C24

Product Reference	Tension Capacity – C24 – $R_{ax,k}$ [kN] <sup>1)</sup>	Shear Capacity – C24 – [kN]					
		Thin Steel <sup>2)</sup>			Thick Steel <sup>3)</sup>		
		Maximum Thickness [mm]	$R_{v,0^\circ,k}$	$R_{v,90^\circ,k}$	Minimum Thickness [mm]	$R_{v,0^\circ,k}$	$R_{v,90^\circ,k}$
ESCRFTC8.0x120	11,5	4	6,25	6,25	8	7,64	7,64
			5,14	5,14		6,52	6,52
ESCRFTC8.0x140	13,6	4	6,74	6,74	8	8,17	8,17
			5,14	5,14		7,04	7,04
ESCRFTC8.0x160	15,7	4	6,74	6,74	8	8,69	8,69
			5,14	5,14		7,27	7,27
ESCRFTC8.0x180	17,8	4	6,74	6,74	8	9,22	9,22
			5,14	5,14		7,27	7,27
ESCRFTC8.0x200	19,9	4	6,74	6,74	8	9,53	9,53
			5,14	5,14		7,27	7,27
ESCRFTC8.0x220	22,0	4	6,74	6,74	8	9,53	9,53
			5,14	5,14		7,27	7,27
ESCRFTC8.0x240	24,1	4	6,74	6,74	8	9,53	9,53
			5,14	5,14		7,27	7,27
ESCRFTC8.0x260	24,1	4	6,74	6,74	8	9,53	9,53
			5,14	5,14		7,27	7,27
ESCRFTC8.0x280	24,1	4	6,74	6,74	8	9,53	9,53
			5,14	5,14		7,27	7,27
ESCRFTC8.0x300	24,1	4	6,74	6,74	8	9,53	9,53
			5,14	5,14		7,27	7,27
ESCRFTC8.0x350	24,1	4	6,74	6,74	8	9,53	9,53
			5,14	5,14		7,27	7,27
ESCRFTC8.0x400	24,1	4	6,74	6,74	8	9,53	9,53
			5,14	5,14		7,27	7,27
ESCRFTC8.0x450	24,1	4	6,74	6,74	8	9,53	9,53
			5,14	5,14		7,27	7,27

<sup>1)</sup> For steel thickness  $\leq d$

<sup>2)</sup> Thin plate thickness  $\leq 0.5 \times d$

<sup>3)</sup> Thick plate thickness  $\geq d$

For intermediate steel thicknesses, the strength can be obtained by interpolation.  
For recommended hole diameter in steel see page 29.

Characteristic capacities	9,53	With pre-drill
	7,27	Without pre-drill

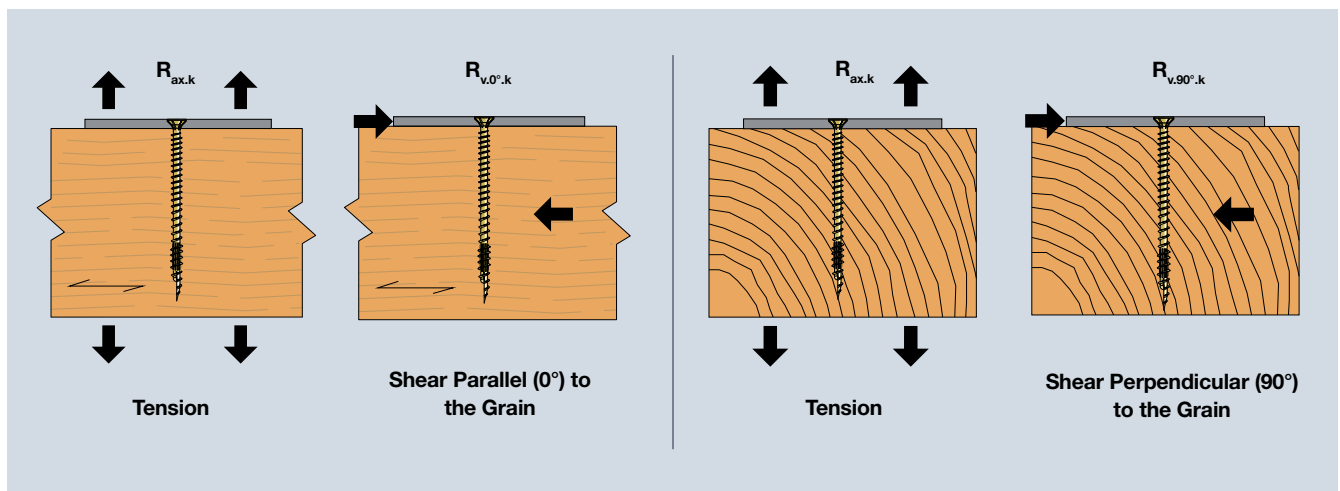

## 4. Steel to Timber Fastening

### ESCRFTC – Characteristic Capacity Steel to Timber C24 (cont.)

Product Reference	Tension Capacity – C24 – $R_{ax,k}$ [kN] <sup>1)</sup>	Shear Capacity – C24 – [kN]					
		Thin Steel <sup>2)</sup>			Thick Steel <sup>3)</sup>		
		Maximum Thickness [mm]	$R_{v,0^\circ,k}$	$R_{v,90^\circ,k}$	Minimum Thickness [mm]	$R_{v,0^\circ,k}$	$R_{v,90^\circ,k}$
ESCRFTC10.0x120	13,5	5	8,38	8,38	10	10,46	10,46
			6,62	6,62		8,66	8,66
ESCRFTC10.0x160	18,5	5	9,63	9,63	10	11,71	11,71
			7,47	7,47		9,91	9,91
ESCRFTC10.0x180	21,0	5	10,01	10,01	10	12,33	12,33
			7,47	7,47		10,53	10,53
ESCRFTC10.0x200	23,5	5	10,01	10,01	10	12,96	12,96
			7,47	7,47		10,57	10,57
ESCRFTC10.0x220	26,0	5	10,01	10,01	10	13,58	13,58
			7,47	7,47		10,57	10,57
ESCRFTC10.0x240	28,5	5	10,01	10,01	10	14,16	14,16
			7,47	7,47		10,57	10,57
ESCRFTC10.0x260	31,0	5	10,01	10,01	10	14,16	14,16
			7,47	7,47		10,57	10,57
ESCRFTC10.0x280	33,5	5	10,01	10,01	10	14,16	14,16
			7,47	7,47		10,57	10,57
ESCRFTC10.0x300	36,0	5	10,01	10,01	10	14,16	14,16
			7,47	7,47		10,57	10,57
ESCRFTC10.0x350	40,0	5	10,01	10,01	10	14,16	14,16
			7,47	7,47		10,57	10,57
ESCRFTC10.0x400	40,0	5	10,01	10,01	10	14,16	14,16
			7,47	7,47		10,57	10,57
ESCRFTC10.0x450	40,0	5	10,01	10,01	10	14,16	14,16
			7,47	7,47		10,57	10,57
ESCRFTC12.0x200	24,2	6	12,28	12,28	12	14,87	14,87
			9,16	9,16		12,52	12,52
ESCRFTC12.0x220	26,9	6	12,47	12,47	12	15,54	15,54
			9,16	9,16		12,95	12,95
ESCRFTC12.0x240	29,6	6	12,47	12,47	12	16,21	16,21
			9,16	9,16		12,95	12,95
ESCRFTC12.0x260	32,3	6	12,47	12,47	12	16,88	16,88
			9,16	9,16		12,95	12,95
ESCRFTC12.0x280	34,9	6	12,47	12,47	12	17,55	17,55
			9,16	9,16		12,95	12,95
ESCRFTC12.0x300	37,6	6	12,47	12,47	12	17,64	17,64
			9,16	9,16		12,95	12,95
ESCRFTC12.0x350	44,4	6	12,47	12,47	12	17,64	17,64
			9,16	9,16		12,95	12,95
ESCRFTC12.0x400	46,7	6	12,47	12,47	12	17,64	17,64
			9,16	9,16		12,95	12,95
ESCRFTC12.0x450	46,7	6	12,47	12,47	12	17,64	17,64
			9,16	9,16		12,95	12,95
ESCRFTC12.0x500	46,7	6	12,47	12,47	12	17,64	17,64
			9,16	9,16		12,95	12,95
ESCRFTC12.0x600	46,7	6	12,47	12,47	12	17,64	17,64
			9,16	9,16		12,95	12,95

<sup>1)</sup> For steel thickness  $\leq d$

<sup>2)</sup> Thin plate thickness  $\leq 0,5 \times d$

<sup>3)</sup> Thick plate thickness  $\geq d$

For intermediate steel thicknesses, the strength can be obtained by interpolation.

For recommended hole diameter in steel see page 29.



## 4. Steel to Timber Fastening

### ESCRFTC – Minimum Distances for Screws in Shear or Combined Loads<sup>1)</sup> Timber to Timber C24

Outer Thread Diameter d [mm]	Pre-drill	Angle Between Load Direction and Screw = 0°						Angle Between Load Direction and Screw = 90°					
		a <sub>1</sub>	a <sub>2</sub>	a <sub>3,c</sub>	a <sub>3,t</sub>	a <sub>4,c</sub>	a <sub>4,t</sub>	a <sub>1</sub>	a <sub>2</sub>	a <sub>3,c</sub>	a <sub>3,t</sub>	a <sub>4,c</sub>	a <sub>4,t</sub>
8.0	With pre-drill	28	17	56	96	24	24	23	23	56	40	24	56
	Without pre-drill	68	28	80	120	40	40	28	28	80	80	40	80
10.0	With pre-drill	35	21	70	120	30	30	28	28	70	50	30	70
	Without pre-drill	84	35	100	150	50	50	35	35	100	100	50	100
12.0	With pre-drill	42	26	84	144	36	36	34	34	84	60	36	84
	Without pre-drill	101	42	120	180	60	60	42	42	120	120	60	120

<sup>1)</sup> Minimum distances comply with EN 1995-1-1 (Eurocode 5) and ETA-13/0796

<sup>2)</sup> Values given in the table is based on the  $\rho_k \leq 350 \text{ kg/m}^3$

<sup>3)</sup> Minimum distances from the unloaded edge perpendicular to the grain may be reduced to  $a_{4,c} = 3 \times d$  if the spacing parallel to the grain ( $a_1$ ) and the end distance ( $a_{3,t}$ ) is at least  $25 \times d$ .

### ESCRFTC – Minimum Distances for Axially Loaded Screws Timber to Timber C24

Outer Thread Diameter d [mm]	a <sub>1</sub>	a <sub>2</sub>	a <sub>3,c</sub>	a <sub>4,c</sub>
8.0	40	28	80	32
10.0	49	35	100	40
12.0	59	42	120	48

\*Valid if the applied centre distances comply with  $a_1 a_2 \geq 25d^2$ .  
Calculation according to EN1995-1-1:2004+A2:2014.

For axially loaded screws installed perpendicular to the surface  $a_{3,t}$  and  $a_{4,t}$  are not relevant. For more info see General Introduction page 24.

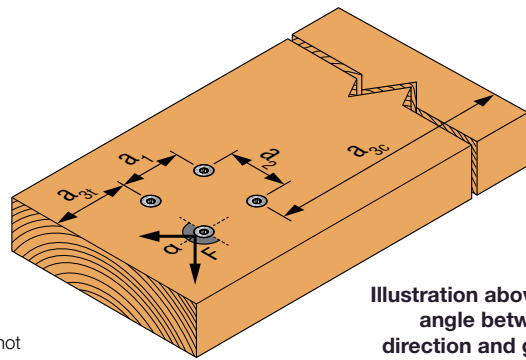

Illustration above shows angle between load direction and grain = 0°

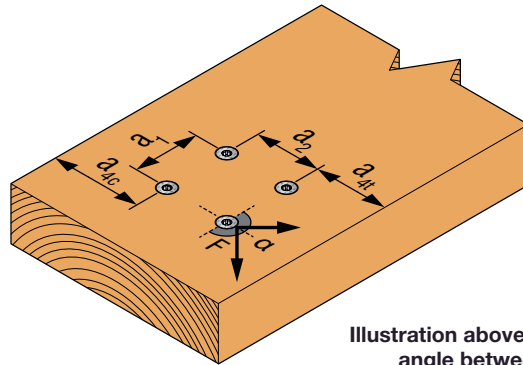

Illustration above shows angle between load direction and grain = 90°

See explanation of  $\alpha$  in General Introduction page 23.

### ESCRFTC – Minimum Distances in the Steel Plate

Outer Thread Diameter d [mm]	a <sub>1</sub> *	a <sub>2</sub> *	e <sub>1</sub> *	e <sub>2</sub> *
8.0	18	20	10	10
10.0	22	24	12	12
12.0	27	29	15	15

\*According to EN 1993-1-8 §3.5

Once you have the spacing and edge distance in steel and timber, you pick the maximum for each dimension between steel and timber.

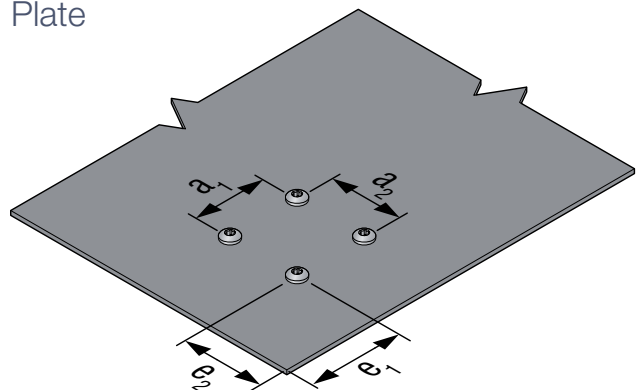



**Precision  
Engineered.**

WSV Quik Drive Collated Wood Screw



**SIMPSON**

**Strong-Tie**

# Boards to Timber Fastening



**Boards to Timber**

WSV .....	256
TTUFS .....	258
TTZNFS .....	260
TTSFS .....	262

## 5. Boards to Timber

### Solid-Drive™ WSV Countersunk WOOD Screw for Boards to Timber

Yellow Zinc Plated  
C2 acc. to EN ISO 12944-2  
SC2 - 50 years acc. to EC5

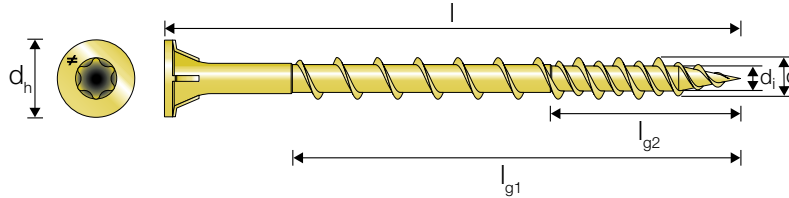

#### WSV - Characteristic Capacities OSB Board to Timber C24



Product Reference	Characteristic Capacity for Panel (OSB, Particle Board $\rho_k \geq 380 \text{ kg/m}^3$ ) to Timber C24 ( $\rho_k \geq 350 \text{ kg/m}^3$ ) Connection Depending of the Thickness of the Panel $t_p$																	
	$t_p = 12$			$t_p = 13$			$t_p = 15$			$t_p = 18$			$t_p = 22$			$t_p = 25$		
	$R_{ax,k.12}$	$R_{v,0^\circ,k.12}$	$R_{v,90^\circ,k.12}$	$R_{ax,k.13}$	$R_{v,0^\circ,k.13}$	$R_{v,90^\circ,k.13}$	$R_{ax,k.15}$	$R_{v,0^\circ,k.15}$	$R_{v,90^\circ,k.15}$	$R_{ax,k.18}$	$R_{v,0^\circ,k.18}$	$R_{v,90^\circ,k.18}$	$R_{ax,k.22}$	$R_{v,0^\circ,k.22}$	$R_{v,90^\circ,k.22}$	$R_{ax,k.25}$	$R_{v,0^\circ,k.25}$	$R_{v,90^\circ,k.25}$
WSV44E	2,03	1,19	1,19	2,03	1,21	1,21	0,00	0,76	0,76	0,00	0,81	0,81	0,00	0,75	0,75	0,00	0,70	0,70
WSV51E	2,42	1,28	1,28	2,42	1,31	1,31	2,42	1,37	1,37	2,23	1,42	1,42	0,00	0,89	0,89	0,00	0,83	0,83
WSV64E	2,42	1,28	1,28	2,42	1,31	1,31	2,42	1,37	1,37	2,42	1,46	1,46	2,42	1,51	1,51	0,00	0,91	0,91
WSV76E	2,42	1,28	1,28	2,42	1,31	1,31	2,42	1,37	1,37	2,42	1,46	1,46	2,42	1,51	1,51	2,42	1,51	1,51

#### WSV - Characteristic Capacities Plywood Board to Timber C24



Product Reference	Characteristic Capacity for Plywood ( $\rho_k \geq 490 \text{ kg/m}^3$ ) to Timber C24 ( $\rho_k \geq 350 \text{ kg/m}^3$ ) Connection Depending of the Thickness of the Panel $t_p$																	
	$t_p = 12$			$t_p = 15$			$t_p = 18$			$t_p = 22$			$t_p = 25$			$t_p = 30$		
	$R_{ax,k.12}$	$R_{v,0^\circ,k.12}$	$R_{v,90^\circ,k.12}$	$R_{ax,k.15}$	$R_{v,0^\circ,k.15}$	$R_{v,90^\circ,k.15}$	$R_{ax,k.18}$	$R_{v,0^\circ,k.18}$	$R_{v,90^\circ,k.18}$	$R_{ax,k.22}$	$R_{v,0^\circ,k.22}$	$R_{v,90^\circ,k.22}$	$R_{ax,k.25}$	$R_{v,0^\circ,k.25}$	$R_{v,90^\circ,k.25}$	$R_{ax,k.30}$	$R_{v,0^\circ,k.30}$	$R_{v,90^\circ,k.30}$
WSV44E	0,00	0,70	0,70	0,00	0,78	0,78	0,00	0,82	0,82	0,00	0,75	0,75	0,00	0,69	0,69	0,00	-	-
WSV51E	2,50	1,32	1,14	0,00	0,78	0,78	0,00	0,87	0,87	0,00	0,89	0,89	0,00	0,83	0,83	0,00	0,73	0,73
WSV64E	2,77	1,39	1,20	2,77	1,47	1,20	2,77	1,56	1,20	0,00	0,90	1,00	0,00	0,90	1,10	0,00	0,90	1,00
WSV76E	2,77	1,39	1,23	2,77	1,47	1,23	2,77	1,56	1,23	2,77	1,60	1,23	2,77	1,60	1,23	2,77	1,60	1,23

For dimensions and characteristic parameters see p. 68.

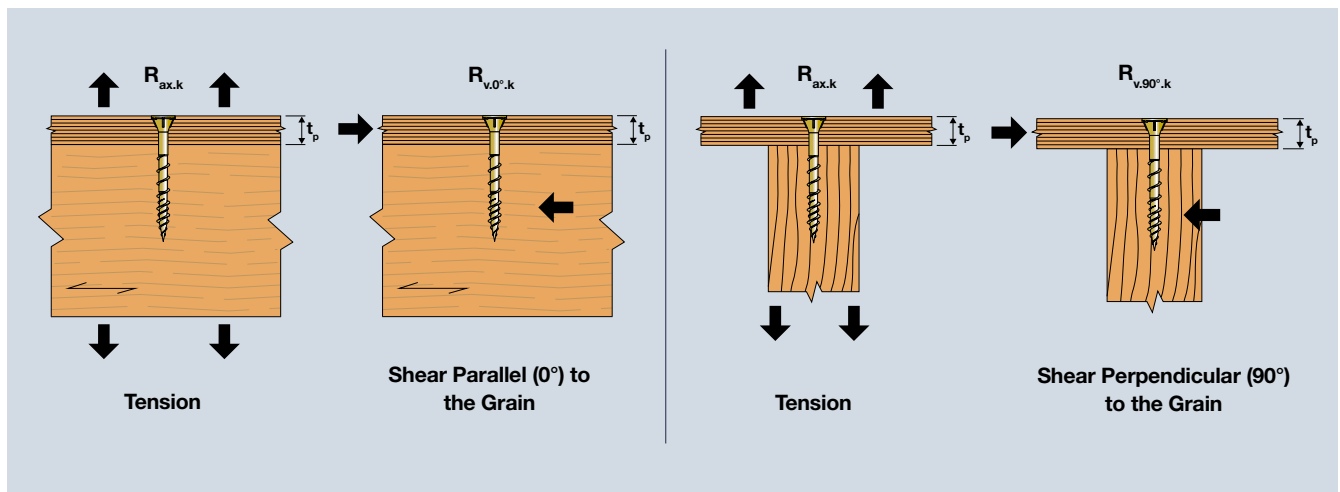

## 5. Boards to Timber

### WSV - Minimum Distances for Screws in Shear or Combined Loads<sup>1)</sup> OSB or Plywood Board to Timber C24

Outer Thread Diameter d [mm]	Pre-drill	Angle Between Load Direction and Screw = 0°						Angle Between Load Direction and Screw = 90°					
		a <sub>1</sub>	a <sub>2</sub>	a <sub>3,c</sub>	a <sub>3,t</sub>	a <sub>4,c</sub>	a <sub>4,t</sub>	a <sub>1</sub>	a <sub>2</sub>	a <sub>3,c</sub>	a <sub>3,t</sub>	a <sub>4,c</sub>	a <sub>4,t</sub>
4.6	With pre-drill	20	12	33	56	14	14	16	16	33	23	14	33
	Without pre-drill	40	20	46	69	23	23	20	20	46	46	23	33

<sup>1)</sup> Minimum distances comply with EN 1995-1-1 (Eurocode 5)

<sup>2)</sup> Values given in the table is based on the  $\rho_k \leq 380 \text{ kg/m}^3$  for OSB and  $\rho_k \leq 490 \text{ kg/m}^3$  for plywood

<sup>3)</sup> Minimum distances from the unloaded edge perpendicular to the grain may be reduced to  $a_{4,c} = 3 \times d$  if the spacing parallel to the grain ( $a_1$ ) and the end distance ( $a_{3,t}$ ) is at least  $25 \times d$ .

### WSV - Minimum Distances for Axially Loaded Screws OSB or Plywood Board to Timber C24

Outer Thread Diameter d [mm]	a <sub>1</sub>	a <sub>2</sub>	a <sub>3,c</sub>	a <sub>4,c</sub>
4.6	28	20	46	19

\*Valid if the applied centre distances comply with  $a_1 \times a_2 \geq 25d^2$ .  
Calculation according to EN1995-1-1:2004+A2:2014.

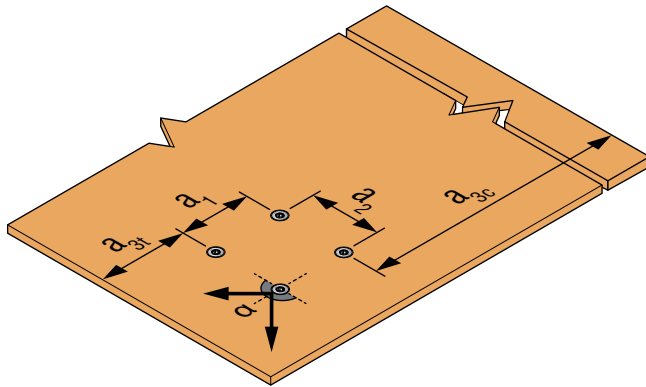

Illustration above shows angle between load direction and grain = 0°

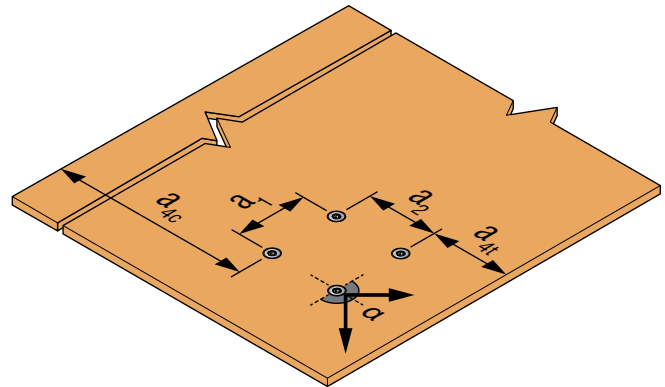

Illustration above shows angle between load direction and grain = 90°

See explanation of  $\alpha$  in General Introduction page 23.



#### Solid Wood Fastener Dimensioning Software

In just four simple steps, Solid Wood guides you through the calculation and selection of fastening solutions suitable for the specific wood structure at hand, all according to Eurocode 5 and our ETA.

Try Solid Wood today. Go to [solidwood.strongtie.eu](http://solidwood.strongtie.eu)

## 5. Boards to Timber

# Solid-Drive™ TTUFS Structural Countersunk WOOD Screw for Boards to Timber

**Electro Galvanised**  
C1 acc. to EN ISO 12944-2  
SC2 - 50 years acc. to EC5

UK  
CA



ETA-21/0670

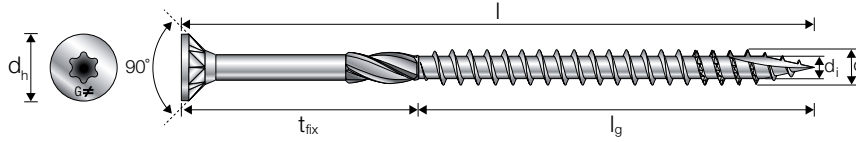

### TTUFS - Characteristic Capacities OSB Board to Timber C24

Product Reference	Characteristic Capacity for Panel (OSB, Particle Board $\rho_k \geq 380 \text{ kg/m}^3$ ) to Timber C24 ( $\rho_k \geq 350 \text{ kg/m}^3$ ) Connection Depending of the Thickness of the Panel $t_p$														
	$t_p = 12$			$t_p = 15$			$t_p = 18$			$t_p = 22$			$t_p = 25$		
	$R_{ax,k,12}$	$R_{v,0^\circ,k,12}$	$R_{v,90^\circ,k,12}$	$R_{ax,k,15}$	$R_{v,0^\circ,k,15}$	$R_{v,90^\circ,k,15}$	$R_{ax,k,18}$	$R_{v,0^\circ,k,18}$	$R_{v,90^\circ,k,18}$	$R_{ax,k,22}$	$R_{v,0^\circ,k,22}$	$R_{v,90^\circ,k,22}$	$R_{ax,k,25}$	$R_{v,0^\circ,k,25}$	$R_{v,90^\circ,k,25}$
TTUFS4.5X25	0,00	-	-	0,00	-	-	0,00	-	-	0,00	-	-	0,00	-	-
TTUFS4.5X30	0,56	-	-	0,56	-	-	0,00	-	-	0,00	-	-	0,00	-	-
TTUFS4.5X35	0,56	-	-	0,56	-	-	0,56	-	-	0,00	-	-	0,00	-	-
TTUFS4.5X40	0,56	0,84	0,84	0,56	0,88	0,88	0,56	-	-	0,71	-	-	0,71	-	-
TTUFS4.5X45	0,56	0,84	0,84	0,56	0,88	0,88	0,56	0,94	0,94	0,71	-	-	0,71	-	-
TTUFS4.5X50	0,56	0,84	0,84	0,56	0,88	0,88	0,56	0,94	0,94	0,71	1,06	1,06	0,71	1,06	1,06
TTUFS4.5X60	0,56	0,84	0,84	0,56	0,88	0,88	0,56	0,94	0,94	0,71	1,06	1,06	0,71	1,13	1,13
TTUFS4.5X70	0,56	0,84	0,84	0,56	0,88	0,88	0,56	0,94	0,94	0,71	1,06	1,06	0,71	1,13	1,13
TTUFS4.5X80	0,56	0,84	0,84	0,56	0,88	0,88	0,56	0,94	0,94	0,71	1,06	1,06	0,71	1,13	1,13
TTUFS5.0X30	0,72	-	-	0,00	-	-	0,00	-	-	0,00	-	-	0,00	-	-
TTUFS5.0X40	0,72	1,03	1,03	0,72	0,97	0,97	0,72	-	-	0,90	-	-	0,00	-	-
TTUFS5.0X50	0,72	1,03	1,03	0,72	1,06	1,06	0,72	1,11	1,11	0,90	1,19	1,19	0,90	1,18	1,18
TTUFS5.0X60	0,72	1,03	1,03	0,72	1,06	1,06	0,72	1,11	1,11	0,90	1,24	1,24	0,90	1,31	1,31
TTUFS5.0X70	0,72	1,03	1,03	0,72	1,06	1,06	0,72	1,11	1,11	0,90	1,24	1,24	0,90	1,31	1,31
TTUFS5.0X80	0,72	1,03	1,03	0,72	1,06	1,06	0,72	1,11	1,11	0,90	1,24	1,24	0,90	1,31	1,31
TTUFS5.0X90	0,72	1,03	1,03	0,72	1,06	1,06	0,72	1,11	1,11	0,90	1,24	1,24	0,90	1,31	1,31
TTUFS5.0X100	0,72	1,03	1,03	0,72	1,06	1,06	0,72	1,11	1,11	0,90	1,24	1,24	0,90	1,31	1,31
TTUFS5.0X120	0,72	1,03	1,03	0,72	1,06	1,06	0,72	1,11	1,11	0,90	1,24	1,24	0,90	1,31	1,31
TTUFS6.0X40	1,08	1,23	1,23	1,08	1,17	1,17	1,08	-	-	0,00	-	-	0,00	-	-
TTUFS6.0X50	1,08	1,31	1,31	1,08	1,36	1,36	1,08	1,41	1,41	1,35	1,43	1,43	1,35	1,42	1,42
TTUFS6.0X60	1,08	1,31	1,31	1,08	1,36	1,36	1,08	1,41	1,41	1,35	1,56	1,56	1,35	1,64	1,64
TTUFS6.0X70	1,08	1,31	1,31	1,08	1,36	1,36	1,08	1,41	1,41	1,35	1,56	1,56	1,35	1,64	1,64
TTUFS6.0X80	1,08	1,31	1,31	1,08	1,36	1,36	1,08	1,41	1,41	1,35	1,56	1,56	1,35	1,64	1,64
TTUFS6.0X90	1,08	1,31	1,31	1,08	1,36	1,36	1,08	1,41	1,41	1,35	1,56	1,56	1,35	1,64	1,64
TTUFS6.0X100	1,08	1,31	1,31	1,08	1,36	1,36	1,08	1,41	1,41	1,35	1,56	1,56	1,35	1,64	1,64
TTUFS6.0X120	1,08	1,31	1,31	1,08	1,36	1,36	1,08	1,41	1,41	1,35	1,56	1,56	1,35	1,64	1,64
TTUFS6.0X140	1,08	1,31	1,31	1,08	1,36	1,36	1,08	1,41	1,41	1,35	1,56	1,56	1,35	1,64	1,64
TTUFS6.0X160	1,08	1,31	1,31	1,08	1,36	1,36	1,08	1,41	1,41	1,35	1,56	1,56	1,35	1,64	1,64
TTUFS6.0X180	1,08	1,31	1,31	1,08	1,36	1,36	1,08	1,41	1,41	1,35	1,56	1,56	1,35	1,64	1,64

For dimensions and characteristic parameters see p. 40.

## 5. Boards to Timber

### TTUFS - Characteristic Capacities Plywood Board to Timber C24



Product Reference	Characteristic Capacity for Plywood ( $\rho_k \geq 490 \text{ kg/m}^3$ ) to Timber C24 ( $\rho_k \geq 350 \text{ kg/m}^3$ ) Connection Depending of the Thickness of the Panel $t_p$														
	$t_p = 12$			$t_p = 15$			$t_p = 18$			$t_p = 22$			$t_p = 25$		
	$R_{ax,k,12}$	$R_{v,0^\circ,k,12}$	$R_{v,90^\circ,k,12}$	$R_{ax,k,15}$	$R_{v,0^\circ,k,15}$	$R_{v,90^\circ,k,15}$	$R_{ax,k,18}$	$R_{v,0^\circ,k,18}$	$R_{v,90^\circ,k,18}$	$R_{ax,k,22}$	$R_{v,0^\circ,k,22}$	$R_{v,90^\circ,k,22}$	$R_{ax,k,25}$	$R_{v,0^\circ,k,25}$	$R_{v,90^\circ,k,25}$
TTUFS4.5X25	0,00	-	-	0,00	-	-	0,00	-	-	0,00	-	-	0,00	-	-
TTUFS4.5X30	0,00	-	-	0,00	-	-	0,00	-	-	0,00	-	-	0,00	-	-
TTUFS4.5X35	0,69	-	-	0,69	-	-	0,00	-	-	0,00	-	-	0,00	-	-
TTUFS4.5X40	0,69	0,94	0,94	0,69	0,97	0,97	0,69	-	-	0,00	-	-	0,00	-	-
TTUFS4.5X45	0,69	0,94	0,94	0,69	1,01	1,01	0,69	1,07	1,07	1,52	-	-	1,32	-	-
TTUFS4.5X50	0,69	0,94	0,94	0,69	1,01	1,01	0,69	1,08	1,08	1,64	1,41	1,41	1,64	1,37	1,37
TTUFS4.5X60	0,69	0,94	0,94	0,69	1,01	1,01	0,69	1,08	1,08	1,64	1,44	1,44	1,64	1,50	1,44
TTUFS4.5X70	0,69	0,94	0,94	0,69	1,01	1,01	0,69	1,08	1,08	1,64	1,44	1,44	1,64	1,50	1,46
TTUFS4.5X80	0,69	0,94	0,94	0,69	1,01	1,01	0,69	1,08	1,08	1,64	1,44	1,44	1,64	1,50	1,51
TTUFS5.0X30	0,00	-	-	0,00	-	-	0,00	-	-	0,00	-	-	0,00	-	-
TTUFS5.0X40	0,88	1,12	1,12	0,88	1,08	1,08	0,88	-	-	0,00	-	-	0,00	-	-
TTUFS5.0X50	0,88	1,14	1,14	0,88	1,20	1,20	0,88	1,28	1,28	2,07	1,59	1,59	1,88	1,56	1,56
TTUFS5.0X60	0,88	1,14	1,14	0,88	1,20	1,20	0,88	1,28	1,28	2,07	1,69	1,69	2,07	1,78	1,78
TTUFS5.0X70	0,88	1,14	1,14	0,88	1,20	1,20	0,88	1,28	1,28	2,07	1,69	1,69	2,07	1,78	1,78
TTUFS5.0X80	0,88	1,14	1,14	0,88	1,20	1,20	0,88	1,28	1,28	2,07	1,69	1,69	2,07	1,78	1,78
TTUFS5.0X90	0,88	1,14	1,14	0,88	1,20	1,20	0,88	1,28	1,28	2,07	1,69	1,69	2,07	1,78	1,78
TTUFS5.0X100	0,88	1,14	1,14	0,88	1,20	1,20	0,88	1,28	1,28	2,07	1,69	1,69	2,07	1,78	1,78
TTUFS5.0X120	0,88	1,14	1,14	0,88	1,20	1,20	0,88	1,28	1,28	2,07	1,69	1,69	2,07	1,78	1,78
TTUFS6.0X40	1,32	1,35	1,35	1,32	1,31	1,31	0,00	-	-	0,00	-	-	0,00	-	-
TTUFS6.0X50	1,32	1,48	1,48	1,32	1,53	1,53	1,32	1,56	1,56	2,10	1,74	1,74	1,88	1,71	1,71
TTUFS6.0X60	1,32	1,48	1,48	1,32	1,53	1,53	1,32	1,61	1,61	2,63	2,05	2,05	2,63	2,11	2,11
TTUFS6.0X70	1,32	1,48	1,48	1,32	1,53	1,53	1,32	1,61	1,61	3,00	2,15	2,15	3,00	2,25	2,25
TTUFS6.0X80	1,32	1,48	1,48	1,32	1,53	1,53	1,32	1,61	1,61	3,00	2,15	2,15	3,00	2,25	2,25
TTUFS6.0X90	1,32	1,48	1,48	1,32	1,53	1,53	1,32	1,61	1,61	3,10	2,17	2,17	3,10	2,27	2,27
TTUFS6.0X100	1,32	1,48	1,48	1,32	1,53	1,53	1,32	1,61	1,61	3,10	2,17	2,17	3,10	2,27	2,27
TTUFS6.0X120	1,32	1,48	1,48	1,32	1,53	1,53	1,32	1,61	1,61	3,10	2,17	2,17	3,10	2,27	2,27
TTUFS6.0X140	1,32	1,48	1,48	1,32	1,53	1,53	1,32	1,61	1,61	3,10	2,17	2,17	3,10	2,27	2,27
TTUFS6.0X160	1,32	1,48	1,48	1,32	1,53	1,53	1,32	1,61	1,61	3,10	2,17	2,17	3,10	2,27	2,27
TTUFS6.0X180	1,32	1,48	1,48	1,32	1,53	1,53	1,32	1,61	1,61	3,10	2,17	2,17	3,10	2,27	2,27

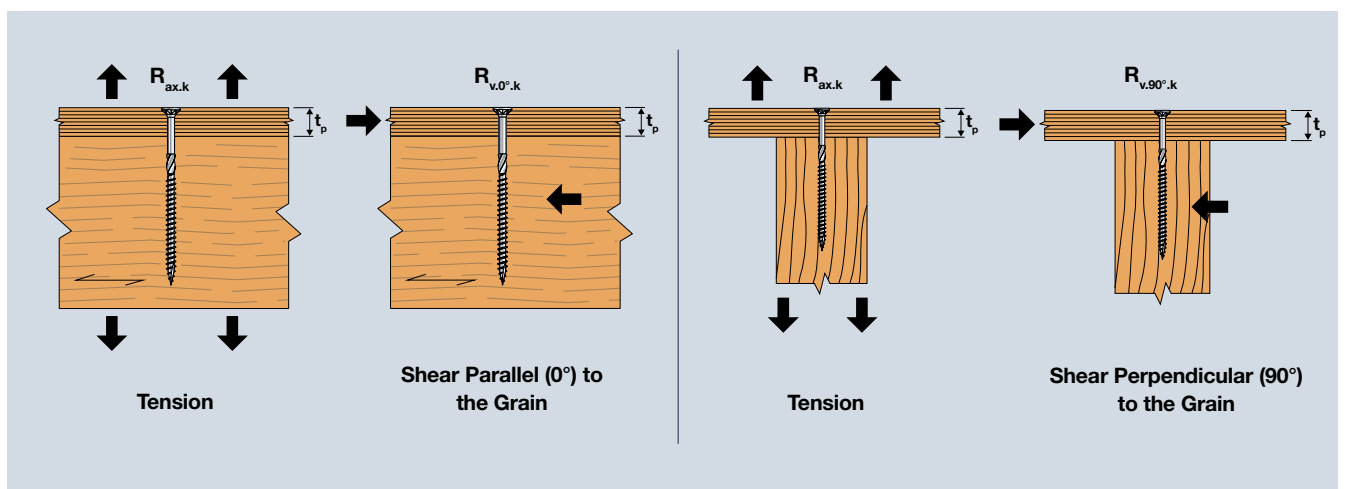



## 5. Boards to Timber

# Solid-Drive™ TTZNFS Structural Countersunk WOOD Screw for Boards to Timber

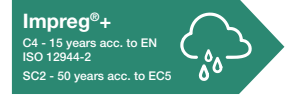

ETA-21/0670

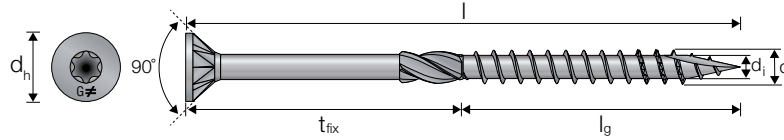

### TTZNFS - Characteristic Capacities OSB Board to Timber C24

Product Reference	Characteristic Capacity for Panel (OSB, Particle Board $\rho_k \geq 380 \text{ kg/m}^3$ ) to Timber C24 ( $\rho_k \geq 350 \text{ kg/m}^3$ ) Connection Depending of the Thickness of the Panel $t_p$														
	$t_p = 12$			$t_p = 15$			$t_p = 18$			$t_p = 22$			$t_p = 25$		
	$R_{ax,k,12}$	$R_{v,0^\circ,k,12}$	$R_{v,90^\circ,k,12}$	$R_{ax,k,15}$	$R_{v,0^\circ,k,15}$	$R_{v,90^\circ,k,15}$	$R_{ax,k,18}$	$R_{v,0^\circ,k,18}$	$R_{v,90^\circ,k,18}$	$R_{ax,k,22}$	$R_{v,0^\circ,k,22}$	$R_{v,90^\circ,k,22}$	$R_{ax,k,25}$	$R_{v,0^\circ,k,25}$	$R_{v,90^\circ,k,25}$
TTZNFS4.5X25	0,00	-	-	0,00	-	-	0,00	-	-	0,00	-	-	0,00	-	-
TTZNFS4.5X30	0,56	-	-	0,56	-	-	0,00	-	-	0,00	-	-	0,00	-	-
TTZNFS4.5X35	0,56	-	-	0,56	-	-	0,56	-	-	0,00	-	-	0,00	-	-
TTZNFS4.5X40	0,56	0,84	0,84	0,56	0,88	0,88	0,56	-	-	0,71	-	-	0,71	-	-
TTZNFS4.5X45	0,56	0,84	0,84	0,56	0,88	0,88	0,56	0,94	0,94	0,71	-	-	0,71	-	-
TTZNFS4.5X50	0,56	0,84	0,84	0,56	0,88	0,88	0,56	0,94	0,94	0,71	1,06	1,06	0,71	1,06	1,06
TTZNFS4.5X60	0,56	0,84	0,84	0,56	0,88	0,88	0,56	0,94	0,94	0,71	1,06	1,06	0,71	1,13	1,13
TTZNFS4.5X70	0,56	0,84	0,84	0,56	0,88	0,88	0,56	0,94	0,94	0,71	1,06	1,06	0,71	1,13	1,13
TTZNFS4.5X80	0,56	0,84	0,84	0,56	0,88	0,88	0,56	0,94	0,94	0,71	1,06	1,06	0,71	1,13	1,13
TTZNFS5.0X30	0,72	-	-	0,00	-	-	0,00	-	-	0,00	-	-	0,00	-	-
TTZNFS5.0X40	0,72	1,03	1,03	0,72	0,97	0,97	0,72	-	-	0,90	-	-	0,00	-	-
TTZNFS5.0X50	0,72	1,03	1,03	0,72	1,06	1,06	0,72	1,11	1,11	0,90	1,19	1,19	0,90	1,18	1,18
TTZNFS5.0X60	0,72	1,03	1,03	0,72	1,06	1,06	0,72	1,11	1,11	0,90	1,24	1,24	0,90	1,31	1,31
TTZNFS5.0X70	0,72	1,03	1,03	0,72	1,06	1,06	0,72	1,11	1,11	0,90	1,24	1,24	0,90	1,31	1,31
TTZNFS5.0X80	0,72	1,03	1,03	0,72	1,06	1,06	0,72	1,11	1,11	0,90	1,24	1,24	0,90	1,31	1,31
TTZNFS5.0X90	0,72	1,03	1,03	0,72	1,06	1,06	0,72	1,11	1,11	0,90	1,24	1,24	0,90	1,31	1,31
TTZNFS5.0X100	0,72	1,03	1,03	0,72	1,06	1,06	0,72	1,11	1,11	0,90	1,24	1,24	0,90	1,31	1,31
TTZNFS5.0X120	0,72	1,03	1,03	0,72	1,06	1,06	0,72	1,11	1,11	0,90	1,24	1,24	0,90	1,31	1,31
TTZNFS6.0X40	1,08	1,23	1,23	1,08	1,17	1,17	1,08	-	-	0,00	-	-	0,00	-	-
TTZNFS6.0X50	1,08	1,31	1,31	1,08	1,36	1,36	1,08	1,41	1,41	1,35	1,43	1,43	1,35	1,42	1,42
TTZNFS6.0X60	1,08	1,31	1,31	1,08	1,36	1,36	1,08	1,41	1,41	1,35	1,56	1,56	1,35	1,64	1,64
TTZNFS6.0X70	1,08	1,31	1,31	1,08	1,36	1,36	1,08	1,41	1,41	1,35	1,56	1,56	1,35	1,64	1,64
TTZNFS6.0X80	1,08	1,31	1,31	1,08	1,36	1,36	1,08	1,41	1,41	1,35	1,56	1,56	1,35	1,64	1,64
TTZNFS6.0X90	1,08	1,31	1,31	1,08	1,36	1,36	1,08	1,41	1,41	1,35	1,56	1,56	1,35	1,64	1,64
TTZNFS6.0X100	1,08	1,31	1,31	1,08	1,36	1,36	1,08	1,41	1,41	1,35	1,56	1,56	1,35	1,64	1,64
TTZNFS6.0X120	1,08	1,31	1,31	1,08	1,36	1,36	1,08	1,41	1,41	1,35	1,56	1,56	1,35	1,64	1,64
TTZNFS6.0X140	1,08	1,31	1,31	1,08	1,36	1,36	1,08	1,41	1,41	1,35	1,56	1,56	1,35	1,64	1,64
TTZNFS6.0X160	1,08	1,31	1,31	1,08	1,36	1,36	1,08	1,41	1,41	1,35	1,56	1,56	1,35	1,64	1,64
TTZNFS6.0X180	1,08	1,31	1,31	1,08	1,36	1,36	1,08	1,41	1,41	1,35	1,56	1,56	1,35	1,64	1,64

# 5. Boards to Timber

## TTZNFS - Characteristic Capacities Plywood Board to Timber C24



Characteristic Capacity for Plywood ( $\rho_k \geq 490 \text{ kg/m}^3$ ) to Timber C24 ( $\rho_k \geq 350 \text{ kg/m}^3$ ) Connection  
Depending of the Thickness of the Panel  $t_p$

Product Reference	$t_p = 12$			$t_p = 15$			$t_p = 18$			$t_p = 22$			$t_p = 25$		
	$R_{ax,k,12}$	$R_{v,0^\circ,k,12}$	$R_{v,90^\circ,k,12}$	$R_{ax,k,15}$	$R_{v,0^\circ,k,15}$	$R_{v,90^\circ,k,15}$	$R_{ax,k,18}$	$R_{v,0^\circ,k,18}$	$R_{v,90^\circ,k,18}$	$R_{ax,k,22}$	$R_{v,0^\circ,k,22}$	$R_{v,90^\circ,k,22}$	$R_{ax,k,25}$	$R_{v,0^\circ,k,25}$	$R_{v,90^\circ,k,25}$
	TTZNFS4.5X25	0,00	-	-	0,00	-	-	0,00	-	-	0,00	-	-	0,00	-
TTZNFS4.5X30	0,00	-	-	0,00	-	-	0,00	-	-	0,00	-	-	0,00	-	-
TTZNFS4.5X35	0,69	-	-	0,69	-	-	0,00	-	-	0,00	-	-	0,00	-	-
TTZNFS4.5X40	0,69	0,94	0,94	0,69	0,97	0,97	0,69	-	-	0,00	-	-	0,00	-	-
TTZNFS4.5X45	0,69	0,94	0,94	0,69	1,01	1,01	0,69	1,07	1,07	1,52	-	-	1,32	-	-
TTZNFS4.5X50	0,69	0,94	0,94	0,69	1,01	1,01	0,69	1,08	1,08	1,64	1,41	1,41	1,64	1,37	1,37
TTZNFS4.5X60	0,69	0,94	0,94	0,69	1,01	1,01	0,69	1,08	1,08	1,64	1,44	1,44	1,64	1,50	1,44
TTZNFS4.5X70	0,69	0,94	0,94	0,69	1,01	1,01	0,69	1,08	1,08	1,64	1,44	1,44	1,64	1,50	1,46
TTZNFS4.5X80	0,69	0,94	0,94	0,69	1,01	1,01	0,69	1,08	1,08	1,64	1,44	1,44	1,64	1,50	1,51
TTZNFS5.0X30	0,00	-	-	0,00	-	-	0,00	-	-	0,00	-	-	0,00	-	-
TTZNFS5.0X40	0,88	1,12	1,12	0,88	1,08	1,08	0,88	-	-	0,00	-	-	0,00	-	-
TTZNFS5.0X50	0,88	1,14	1,14	0,88	1,20	1,20	0,88	1,28	1,28	2,07	1,59	1,59	1,88	1,56	1,56
TTZNFS5.0X60	0,88	1,14	1,14	0,88	1,20	1,20	0,88	1,28	1,28	2,07	1,69	1,69	2,07	1,78	1,78
TTZNFS5.0X70	0,88	1,14	1,14	0,88	1,20	1,20	0,88	1,28	1,28	2,07	1,69	1,69	2,07	1,78	1,78
TTZNFS5.0X80	0,88	1,14	1,14	0,88	1,20	1,20	0,88	1,28	1,28	2,07	1,69	1,69	2,07	1,78	1,78
TTZNFS5.0X90	0,88	1,14	1,14	0,88	1,20	1,20	0,88	1,28	1,28	2,07	1,69	1,69	2,07	1,78	1,78
TTZNFS5.0X100	0,88	1,14	1,14	0,88	1,20	1,20	0,88	1,28	1,28	2,07	1,69	1,69	2,07	1,78	1,78
TTZNFS5.0X120	0,88	1,14	1,14	0,88	1,20	1,20	0,88	1,28	1,28	2,07	1,69	1,69	2,07	1,78	1,78
TTZNFS6.0X40	1,32	1,35	1,35	1,32	1,31	1,31	0,00	-	-	0,00	-	-	0,00	-	-
TTZNFS6.0X50	1,32	1,48	1,48	1,32	1,53	1,53	1,32	1,56	1,56	2,10	1,74	1,74	1,88	1,71	1,71
TTZNFS6.0X60	1,32	1,48	1,48	1,32	1,53	1,53	1,32	1,61	1,61	2,63	2,05	2,05	2,63	2,11	2,11
TTZNFS6.0X70	1,32	1,48	1,48	1,32	1,53	1,53	1,32	1,61	1,61	3,00	2,15	2,15	3,00	2,25	2,25
TTZNFS6.0X80	1,32	1,48	1,48	1,32	1,53	1,53	1,32	1,61	1,61	3,00	2,15	2,15	3,00	2,25	2,25
TTZNFS6.0X90	1,32	1,48	1,48	1,32	1,53	1,53	1,32	1,61	1,61	3,10	2,17	2,17	3,10	2,27	2,27
TTZNFS6.0X100	1,32	1,48	1,48	1,32	1,53	1,53	1,32	1,61	1,61	3,10	2,17	2,17	3,10	2,27	2,27
TTZNFS6.0X120	1,32	1,48	1,48	1,32	1,53	1,53	1,32	1,61	1,61	3,10	2,17	2,17	3,10	2,27	2,27
TTZNFS6.0X140	1,32	1,48	1,48	1,32	1,53	1,53	1,32	1,61	1,61	3,10	2,17	2,17	3,10	2,27	2,27
TTZNFS6.0X160	1,32	1,48	1,48	1,32	1,53	1,53	1,32	1,61	1,61	3,10	2,17	2,17	3,10	2,27	2,27
TTZNFS6.0X180	1,32	1,48	1,48	1,32	1,53	1,53	1,32	1,61	1,61	3,10	2,17	2,17	3,10	2,27	2,27

For dimensions and characteristic parameters see p. 40.

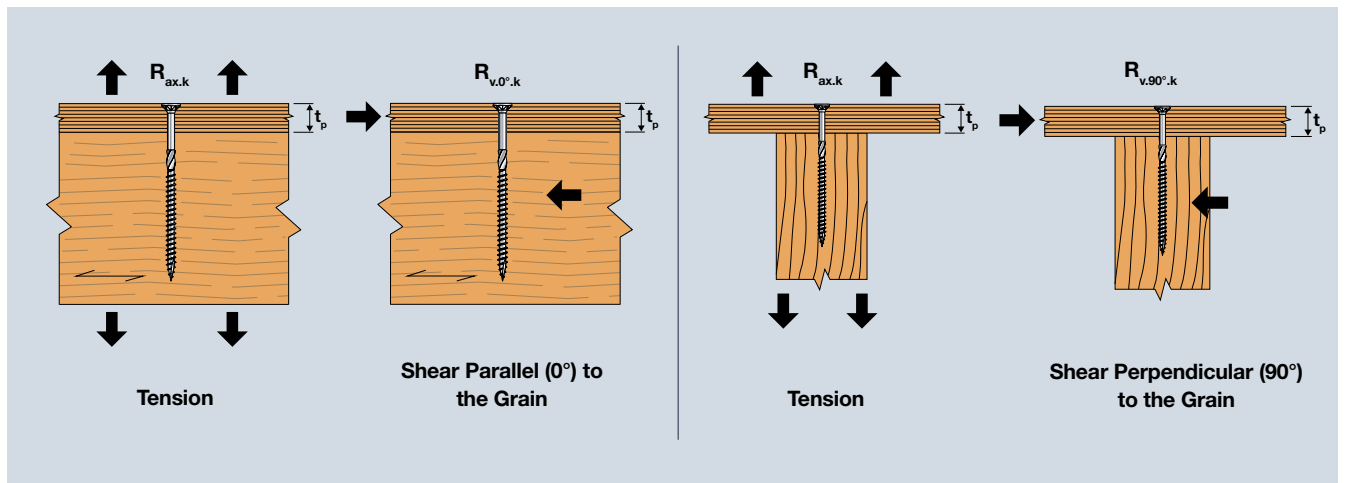

## 5. Boards to Timber

### Solid-Drive™ TTSFS Structural Countersunk WOOD Screw for Boards to Timber

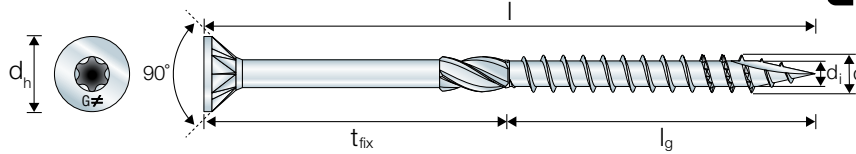

#### TTSFS - Characteristic Capacities OSB Board to Timber C24

Product Reference	Characteristic Capacity for Panel (OSB, Particle Board $\rho_k \geq 380 \text{ kg/m}^3$ ) to Timber C24 ( $\rho_k \geq 350 \text{ kg/m}^3$ ) Connection Depending of the Thickness of the Panel $t_p$														
	$t_p = 12$			$t_p = 15$			$t_p = 18$			$t_p = 22$			$t_p = 25$		
	$R_{ax,k,12}$	$R_{v,0^\circ,k,12}$	$R_{v,90^\circ,k,12}$	$R_{ax,k,15}$	$R_{v,0^\circ,k,15}$	$R_{v,90^\circ,k,15}$	$R_{ax,k,18}$	$R_{v,0^\circ,k,18}$	$R_{v,90^\circ,k,18}$	$R_{ax,k,22}$	$R_{v,0^\circ,k,22}$	$R_{v,90^\circ,k,22}$	$R_{ax,k,25}$	$R_{v,0^\circ,k,25}$	$R_{v,90^\circ,k,25}$
TTSFS5.0X60	0,72	0,91	0,91	0,72	0,96	0,96	0,72	1,02	1,02	0,90	1,16	1,16	0,90	1,24	1,24
TTSFS5.0X70	0,72	0,91	0,91	0,72	0,96	0,96	0,72	1,02	1,02	0,90	1,16	1,16	0,90	1,24	1,24
TTSFS5.0X80	0,72	0,91	0,91	0,72	0,96	0,96	0,72	1,02	1,02	0,90	1,16	1,16	0,90	1,24	1,24
TTSFS5.0X90	0,72	0,91	0,91	0,72	0,96	0,96	0,72	1,02	1,02	0,90	1,16	1,16	0,90	1,24	1,24
TTSFS5.0X100	0,72	0,91	0,91	0,72	0,96	0,96	0,72	1,02	1,02	0,90	1,16	1,16	0,90	1,24	1,24
TTSFS5.0X120	0,72	0,91	0,91	0,72	0,96	0,96	0,72	1,02	1,02	0,90	1,16	1,16	0,90	1,24	1,24
TTSFS6.0X70	1,08	1,28	1,28	1,08	1,32	1,32	1,08	1,37	1,37	1,35	1,53	1,53	1,35	1,60	1,60
TTSFS6.0X80	1,08	1,28	1,28	1,08	1,32	1,32	1,08	1,37	1,37	1,35	1,53	1,53	1,35	1,60	1,60
TTSFS6.0X90	1,08	1,28	1,28	1,08	1,32	1,32	1,08	1,37	1,37	1,35	1,53	1,53	1,35	1,60	1,60
TTSFS6.0X100	1,08	1,28	1,28	1,08	1,32	1,32	1,08	1,37	1,37	1,35	1,53	1,53	1,35	1,60	1,60
TTSFS6.0X120	1,08	1,28	1,28	1,08	1,32	1,32	1,08	1,37	1,37	1,35	1,53	1,53	1,35	1,60	1,60
TTSFS6.0X140	1,08	1,28	1,28	1,08	1,32	1,32	1,08	1,37	1,37	1,35	1,53	1,53	1,35	1,60	1,60

#### TTSFS - Characteristic Capacities Plywood Board to Timber C24

Product Reference	Characteristic Capacity for Plywood ( $\rho_k \geq 490 \text{ kg/m}^3$ ) to Timber C24 ( $\rho_k \geq 350 \text{ kg/m}^3$ ) Connection Depending of the Thickness of the Panel $t_p$														
	$t_p = 12$			$t_p = 15$			$t_p = 18$			$t_p = 22$			$t_p = 25$		
	$R_{ax,k,12}$	$R_{v,0^\circ,k,12}$	$R_{v,90^\circ,k,12}$	$R_{ax,k,15}$	$R_{v,0^\circ,k,15}$	$R_{v,90^\circ,k,15}$	$R_{ax,k,18}$	$R_{v,0^\circ,k,18}$	$R_{v,90^\circ,k,18}$	$R_{ax,k,22}$	$R_{v,0^\circ,k,22}$	$R_{v,90^\circ,k,22}$	$R_{ax,k,25}$	$R_{v,0^\circ,k,25}$	$R_{v,90^\circ,k,25}$
TTSFS5.0X60	0,88	1,03	1,03	0,88	1,10	1,10	0,88	1,19	1,19	1,97	1,58	1,58	1,97	1,63	1,67
TTSFS5.0X70	0,88	1,03	1,03	0,88	1,10	1,10	0,88	1,19	1,19	1,97	1,58	1,58	1,97	1,63	1,68
TTSFS5.0X80	0,88	1,03	1,03	0,88	1,10	1,10	0,88	1,19	1,19	1,97	1,58	1,58	1,97	1,63	1,68
TTSFS5.0X90	0,88	1,03	1,03	0,88	1,10	1,10	0,88	1,19	1,19	1,97	1,58	1,58	1,97	1,63	1,68
TTSFS5.0X100	0,88	1,03	1,03	0,88	1,10	1,10	0,88	1,19	1,19	1,97	1,58	1,58	1,97	1,63	1,68
TTSFS5.0X120	0,88	1,03	1,03	0,88	1,10	1,10	0,88	1,19	1,19	1,97	1,58	1,58	1,97	1,63	1,68
TTSFS6.0X70	1,32	1,43	1,43	1,32	1,49	1,49	1,32	1,57	1,57	2,75	2,05	2,05	2,75	2,15	2,15
TTSFS6.0X80	1,32	1,43	1,43	1,32	1,49	1,49	1,32	1,57	1,57	2,75	2,05	2,05	2,75	2,15	2,15
TTSFS6.0X90	1,32	1,43	1,43	1,32	1,49	1,49	1,32	1,57	1,57	2,75	2,05	2,05	2,75	2,15	2,15
TTSFS6.0X100	1,32	1,43	1,43	1,32	1,49	1,49	1,32	1,57	1,57	2,75	2,05	2,05	2,75	2,15	2,15
TTSFS6.0X120	1,32	1,43	1,43	1,32	1,49	1,49	1,32	1,57	1,57	2,75	2,05	2,05	2,75	2,15	2,15
TTSFS6.0X140	1,32	1,43	1,43	1,32	1,49	1,49	1,32	1,57	1,57	2,75	2,05	2,05	2,75	2,15	2,15

For dimensions and characteristic parameters see p. 40.

## 5. Boards to Timber

### TTUFS/TTZNFS/TTSFS - Minimum Distances for Screws in Shear or Combined Loads<sup>1)</sup> OSB or Plywood Board to Timber C24

Outer Thread Diameter d [mm]	Pre-drill	Angle Between Load Direction and Screw = 0°						Angle Between Load Direction and Screw = 90°					
		a <sub>1</sub>	a <sub>2</sub>	a <sub>3,c</sub>	a <sub>3,t</sub>	a <sub>4,c</sub>	a <sub>4,t</sub>	a <sub>1</sub>	a <sub>2</sub>	a <sub>3,c</sub>	a <sub>3,t</sub>	a <sub>4,c</sub>	a <sub>4,t</sub>
4.5	With pre-drill	20	12	32	54	14	14	16	16	32	23	14	32
	Without pre-drill	39	20	45	68	23	23	20	20	45	45	23	32
5.0	With pre-drill	22	13	35	60	15	15	17	17	35	25	15	35
	Without pre-drill	51	22	50	75	25	25	22	22	50	50	25	35
6.0	With pre-drill	26	16	42	72	18	18	21	21	42	30	18	42
	Without pre-drill	62	26	60	90	30	30	26	26	60	60	30	42

<sup>1)</sup> Minimum distances comply with EN 1995-1-1 (Eurocode 5) and ETA 21/0670

<sup>2)</sup> Values given in the table is based on the  $\rho_k \leq 380 \text{ kg/m}^3$  for OSB and  $\rho_k \leq 490 \text{ kg/m}^3$  for plywood

<sup>3)</sup> Minimum distances from the unloaded edge perpendicular to the grain may be reduced to  $a_{4,c} = 3 \times d$  if the spacing parallel to the grain ( $a_1$ ) and the end distance ( $a_{3,t}$ ) is at least  $25 \times d$ .

### TTUFS/TTZNFS/TTSFS - Minimum Distances for Axially Loaded Screws OSB or Plywood Board to Timber C24

Outer Thread Diameter d [mm]	a <sub>1</sub>	a <sub>2</sub>	a <sub>3c</sub>	a <sub>4c</sub>
4.5	27	20	45	18
5.0	30	22	50	20
6.0	36	26	60	24

\*Valid if the applied centre distances comply with  $a_1 \times a_2 \geq 25d^2$ .  
Calculation according to EN1995-1-1:2004+A2:2014.

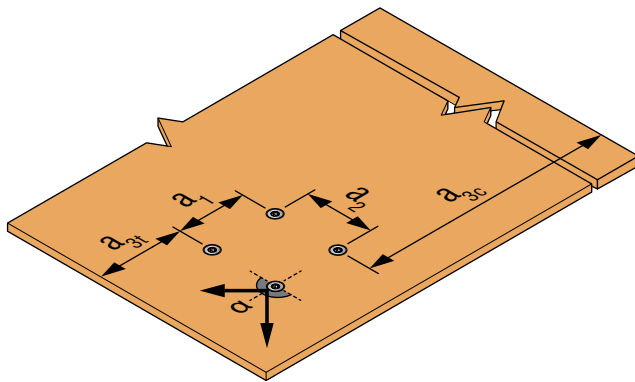

Illustration above shows angle between load direction and grain = 0°

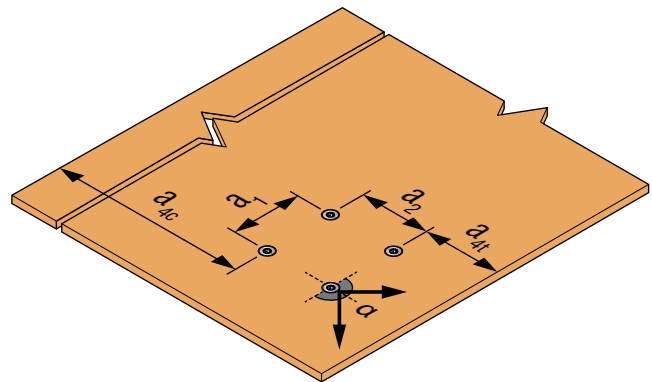

Illustration above shows angle between load direction and grain = 90°

See explanation of  $\alpha$  in General Introduction page 23.



#### Solid Wood Fastener Dimensioning Software

In just four simple steps, Solid Wood guides you through the calculation and selection of fastening solutions suitable for the specific wood structure at hand, all according to Eurocode 5 and our ETA.

Try Solid Wood today. Go to [solidwood.strongtie.eu](http://solidwood.strongtie.eu)

# Notes

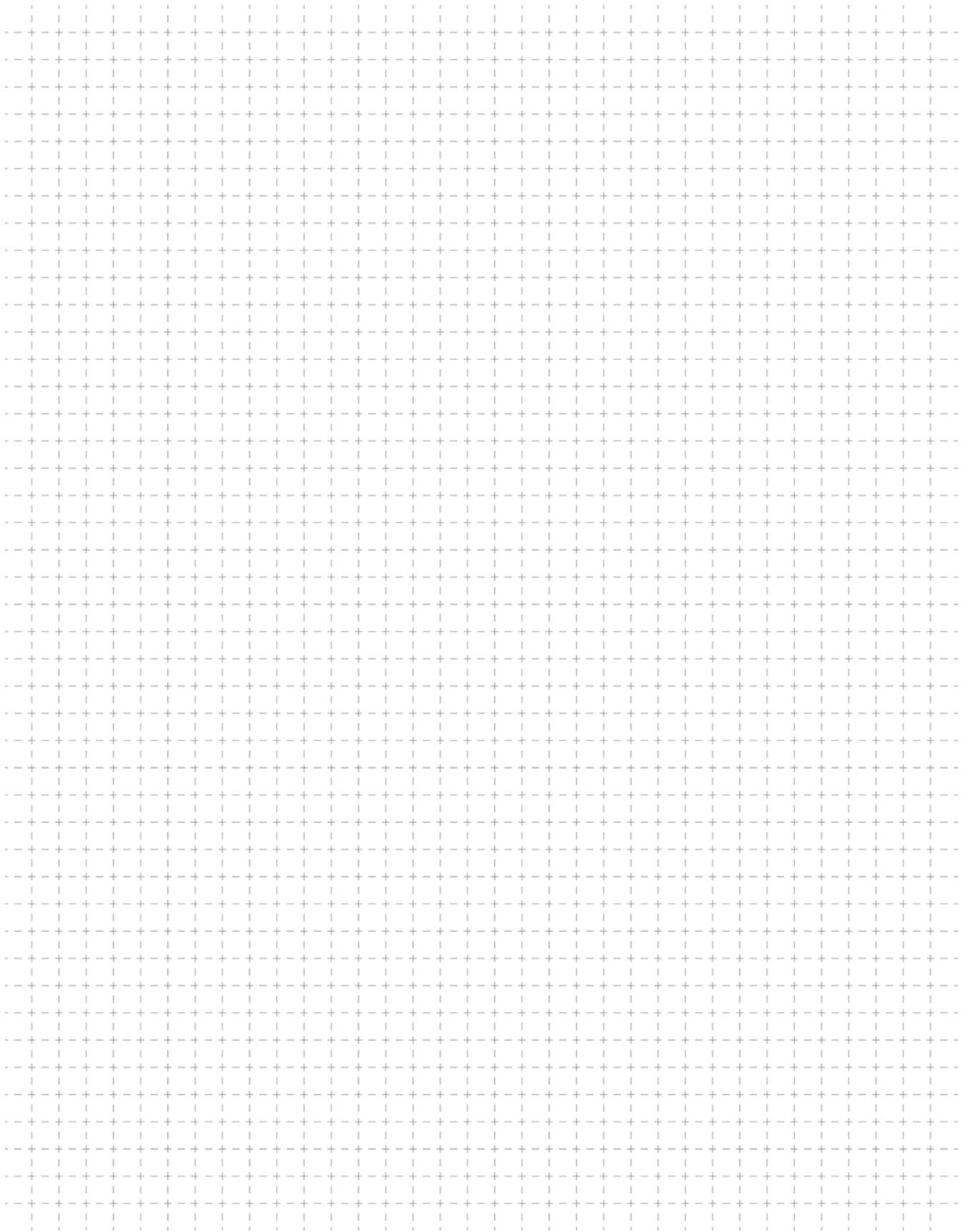

### Solid Wood Fastener Dimensioning Software

In just four simple steps, Solid Wood guides you through the calculation and selection of fastening solutions suitable for the specific wood structure at hand, all according to Eurocode 5 and our ETA.

Try Solid Wood today. Go to [solidwood.strongtie.eu](https://solidwood.strongtie.eu)

# Notes

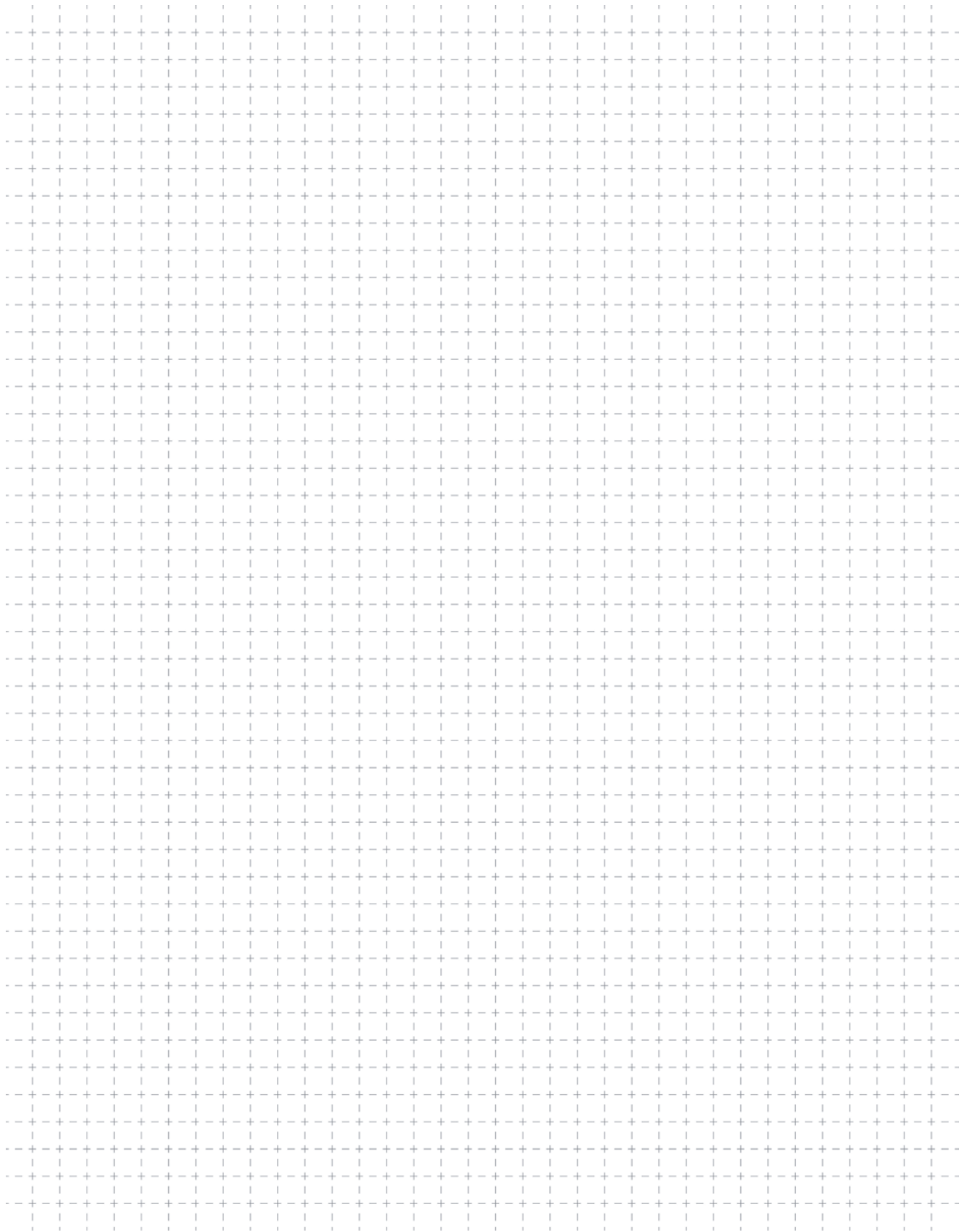

C-F-EU-TG-2023 © 2023 SIMPSON STRONG-TIE COMPANY INC.



### Solid Wood Fastener Dimensioning Software

In just four simple steps, Solid Wood guides you through the calculation and selection of fastening solutions suitable for the specific wood structure at hand, all according to Eurocode 5 and our ETA.

Try Solid Wood today. Go to [solidwood.strongtie.eu](https://solidwood.strongtie.eu)

# Notes

A large grid of dashed lines for taking notes, consisting of approximately 30 columns and 40 rows.



### Solid Wood Fastener Dimensioning Software

In just four simple steps, Solid Wood guides you through the calculation and selection of fastening solutions suitable for the specific wood structure at hand, all according to Eurocode 5 and our ETA.

Try Solid Wood today. Go to [solidwood.strongtie.eu](https://solidwood.strongtie.eu)



# Solid-Drive™



## High-Performance Structural Wood Fasteners.



For inclined and angled installations of our Solid-Drive screws, we recommend using the GSCREW installation guide.



When it comes to structural fasteners, Solid-Drive is the only name you need to know. Our professional-grade screws and nails are precision engineered for strength, versatility and reliability. With innovative designs that make driving fast and easy, the entire Simpson Strong-Tie® Solid-Drive line helps keep installed costs low while meeting the highest demands. Our broad selection of fasteners is available in a wide variety of lengths for any application.

To learn more, go to [strongtie.eu](http://strongtie.eu)

**SIMPSON**

**Strong-Tie®**

At Simpson Strong-Tie®, we do innovation a little differently. It's part of our legacy, part of our mission, and part of our future. Through precision engineering and rigorous testing, we're pushing the boundaries of product design to meet ever-greater challenges of the industry. It's our job to meet your most demanding applications with the fastest, easiest and strongest solutions, and it's our promise to deliver the expert knowledge and support you need to build safer and smarter.

$$f_{t,90,k} \times k_{mod} / \gamma_m = 1,60 \text{ N/mm}^2$$

$$R_{t,90,k} = 39,52 \text{ kN} < 60 \text{ kN}$$

Axial Resistance of the screw

Compressive stress perpendicular to grain  
Timber design compressive capacity

$$F_{ax,90,k} = f_{ax,calc,k} \times d \times l_{ef} = 14,1 \times 8 \text{ mm} \times 75 \text{ mm} = 6,39 \text{ kN}$$

with:  $l_{ef}$  thread length

$d$  screw thread diameter  
 $f_{ax,calc,k}$  characteristic withdrawal parameter in GL24

# Fasteners engineered with engineers in mind.

$$f_{ax,calc,k} = f_{ax,k} \times (p/350)^{0,8} = 13,1 \times (385/350)^{0,8} = 14,1 \text{ N/mm}^2$$

Characteristic capacity when the load is at 45°

$$F_{ax,45,k} = F_{ax,90,k} \times \cos \alpha = 4,51 \text{ kN}$$

Characteristic axial resistance of the pair of screw

